



I.Mak®
REDÜKTÖR & VARYATÖR A.Ş.

Vinç Sistemleri Kaldırma Redüktörü

Hoist Drive Geared Motor / Motoréducteurs à Tambour

C02



SERIES
IRC

2019
TR | EN | FR

Gearboxes and Drives / Moto Réducteurs



İRC Serisi Redüktörlerin Genel Özellikleri Descriptions and Specifications of the IRC Serie / Descriptions et spécifications de la série IRC	6-7
Teknik Tanımlamalar Technical Explanations / Descriptions techniques	8-10
Tip Tanımlamaları Unit Designation / Types et designations	11
Opsiyonlar Options / Options	12
Redüktör Bağlantı Varyasyonları Mounting Options and Variations / <i>Options de montage et d'accouplement</i>	13
Redüktör Komponent Varyasyonları Gearboxes Components Variations / <i>Options et variations</i>	14
Motor Varyasyonları Mounting Options and Variations / <i>Options de montage et d'accouplement</i>	15
Motor komponent varyasyonları Motor's Components Variations / <i>Composant et options moteurs</i>	16-17
Frenler Brakes / <i>Freins</i>	18-19
Fren Seçim Tablosu Brake Selection Table / <i>Table de sélection des freins</i>	20
Tambur Bağlantı Flanşı Drum Connection Flange / <i>Bride de connexion au tambour</i>	21
Yapı Sınıflandırması Structures Classification / <i>Classement des appareils</i>	22-23
Mekanizma Sınıflandırması Mechanisms Classification / <i>Classement des mecanismes</i>	24-25

Servis Faktörü Service Factor / <i>Service facteur</i>	26
Redüktörlerin Kontrol ve Bakımları Control and Maintenance Gearboxes / <i>Contrôle et maintenance des réducteurs</i>	27
Montaj Pozisyonları ve Yağ Miktarları Mounting Positions and Oil Quantities / <i>Positions de montage et quantités d'huiles</i>	28
Motor Büyüklüğüne Göre Geometrik Mümkün Çevrim Oranları Geometrically Possible Combinations of Ratios According to Motor Size / <i>Combinaisons de ratios possibles en fonction de la configuration moteur</i>	29
Yağ Tablosu Lubricant Table / <i>Huiles et lubrifiants</i>	30
Klemens Pozisyonları Position of Terminal Box / <i>Position de la boîte à bornes</i>	31
Redüktör Seçim Formu Gearbox Selection Form / <i>Formulaire de sélection des réducteurs</i>	32-34
Redüktör Sipariş Gearbox Ordering / <i>Commandez votre réducteur</i>	35
Motor İşletme Değerleri Motor Performance / <i>Performance moteurs</i>	36-37
Vinç Sistemleri Kaldırma Redüktörleri Güç ve Devir Tabloları Power and Ratio Table for Hoisting Applications / <i>Tableau de classification des couples et rapports de réduction pour les applications de levage</i>	40-265
Vinç Sistemleri Kaldırma Redüktörleri Ölçü Sayfaları Dimensions Pages / <i>Dimensions</i>	268-277
Vinç Sistemleri Kaldırma Redüktörleri Yedek Parça Şeması Spare Parts List / <i>Liste des composants</i>	278
Vinç Sistemleri Kaldırma Redüktörleri Yedek Parça Listesi Spare Parts List / <i>Liste des composants</i>	279

IRC

SERİSİ / SERIES / SÉRIES



- Monoblok döküm gövdeli
- 5 Farklı gövde büyüklüğü
- 800 – 13000 Nm moment aralığı
- 24 – 198 Tahvil aralığı

- Cast iron monobloc housing
- 5 Size of housing
- Torque range from 800 to 13000 Nm
- Ratio range from 24 to 198

- *Carter monobloc en fonte*
- *5 tailles de carter*
- *Couple allant de 800 à 13000 Nm*
- *Rapport de réduction compris entre 24 et 198*

Genel Bilgiler

General Information
Informations g n rales

İRC serisi redüktörlerin genel özellikleri

İ.Mak redüktör tarafından üretilen İRC serisi redüktörler, monoblok gövde yapısında, helisel dişli ve üç kademeli vinç tamburu tahrik redüktörleridir.

İRC serisi redüktörler beş adet gövde büyüklüğüne sahiptir. 0,5 ton ile 50 ton aralığında uygulamalarda kullanılmaktadır.

İRC serisi redüktörlerin, tahvil aralığı 24 ile 198, tambur çapı aralığı 110mm ile 450mm, kaldırma hızı aralığı 0,5m/dk ile 44m/dk arasındadır.

İRC serisi redüktörler, monoblok gövde yapısındadır. Ve işleme merkezlerimizde, tüm eksenleri tek operasyonda işlenmektedir. Vinçlerde kullanılan büyük çapta tamburlar halat ömrünü uzatmaktadır. Bu sebepten, büyük çaplarda tamburlar kullanabilmek için, redüktörlerin giriş ve çıkış eksen aralığı geniş tutulmuştur

İRC serisi redüktörlerin yüksek radyal yük taşıyabilmesi için yataklama boyu uzun tutulmuş ve konik masuralı rulmanlar kullanılmıştır. Daha düşük hacimde daha yüksek ISO/FEM sınıflarını karşılayabilmek için redüktör içerisinde geniş dişliler kullanılmıştır. Gövde GG20 pik malzemedir, dişliler sertleştirilmiş sementasyon çeliğinden imal edilmektedir. Çıkış milleri DIN5480'e göre, 50 HRC değerinde sertleştirilerek, isteğe bağlı farklı ölçülerde çoklu kamalı olarak üretilmektedir.

İRC serisi redüktörlere A-DIN EN 50 347 standardına göre PAM B5 flanşlı motorlar bağlanabilmektedir. Özel istekler için lütfen iletişime geçiniz.

Descriptions and specifications of the IRC serie.

Developed and produced by I-MAK Gearboxes and drives. The IRC Series is composed of a Monobloc housing combined with 3 stages of gears. This gearbox is designed for hoist and winch applications. Available in 5 sizes of housing, the gearboxes of the IRC Series are designed to lift bulks in between 0.50 and 50 tonnes.

The IRC series present a wide range of technical specifications for each options and parts. The ratios are rating from 24 to 198, the diameter of the drum is starting from 110 and is available with sizes up to 450 mm, and the geared motor propose up to 5 falls.

Our sharp production process, provide high quality for the Monobloc housing of this gearbox. The different operations of production are operated on the last generation of CNC machines to provide high precision for all the technical features of the housing. We also adapted the process of production for the applications with a large drum diameter, these specifics adaptations are directly helping to reach a longer lifetime of the gearbox.

The geared motors of the IRC series are designed to support high radial loads, to achieve this feature we are using specific bearings placed in deeper emplacements compared to other gearboxes. To match with the highest ISO/FEM Standards bigger gears are also used to guarantee higher outcome from the geared motors. The selection of the material is made to provide a high resistance and long lifetime to the housing (GG20 Iron cast) and the output shafts(DIN480).

According to the A-DIN EN 50347 norms all the gearboxes of the IRC Series can be mounted with a B5 PAM Flange by consulting the factory or your local reseller you can also get access to special options or particular machining for your projects.

Descriptions et spécifications de la série IRC.

Développée par I-MAK Reduktor, la nouvelle série IRC est destinée aux applications de levage et grues. Composés d'un carter monobloc en fonte et de 3 étapes de pignons, les réducteurs de la série IRC peuvent être directement au tambour de votre application.

Disponibles en 5 tailles de carters, les réducteurs de la série IRC présentent des caractéristiques techniques adaptés à des charges allant de 0.5 tonnes à 50 tonnes.

La série IRC présente une large gamme de spécifications techniques et d'options. Les rapports de réduction disponibles s'étendent de 24 à 198, le diamètre du tambour s'étend de 110 à 450 mm proposant ainsi jusqu'à 5 retombées.

Nos procédés d'usinage permettent d'obtenir des carters d'une grande qualité grâce à la précision de nos machines d'usinages de dernière génération. Nous avons aussi adapté nos procédés de fabrication pour les réducteurs destinés aux applications nécessitant des tambours d'un large diamètre, permettant ainsi de prolonger la durée de vie d'applications habituellement sensibles.

Conçus pour supporter de fortes sollicitations radiales, les réducteurs de la série IRC sont fournis avec des roulements spéciaux logés dans des canaux allongés pour permettre une absorption optimale des charges. Les pignons présentent des diamètres élargis pour permettre une optimisation des rendements basés sur les normes ISO et FEM. Les matériaux sont également sélectionnés pour garantir une plus grande résistance et une durée de vie prolongée des cartes (GG20 – Fonte) et des arbres de sorties (DIN480).

Tous les réducteurs de la série IRC répondent aux normes A-DIN EN 50347 et sont donc compatibles aux brides PAM B5. Nous vous invitons également à contacter notre usine ou le revendeur le plus proche pour avoir accès aux options et usinage spéciaux pour vos projets.

Teknik tanımlamalar

Vinç sınıfları	Vinç sınıfları toplam çalışma süresi ve yükleme durumuna göre değişkenlik gösterir. ISO 4301/1 standardına göre M1 ile M8 arasında, FEM 9.511/86 standardına göre 1Dm ile 5m arasında vinç sınıfları vardır.
Yükleme türü	Toplamda 4 çeşit yükleme sınıfı vardır. Bunlar; Hafif, Orta, Ağır ve Çok Ağır diye adlandırılır.
Kaldırma kapasitesi	Bir vincin kaldırabileceği maksimum yükü ifade eder.
Kanca yüksekliği	Vincin kancasının en yüksekteki ile en alçaktaki pozisyonları arasındaki mesafedir.
Halat donam düzeni	Halat donam düzeni N/nh-h şeklinde ifade edilir. N: Toplam halat donam sayısı nh: Tamburdan çıkan halat sayısı h: Kanca sayısı Kanca sayısı genellikle 1 olduğunda gösterilmez.
Tambur çapı	Tambur çapı aşağıdaki formül ile hesaplanır: $DT = h1 \times d$ DT: Tambur çapı d: Halat çapı h1: Katsayı (aşağıdaki tablodan bakınız.)

FEM Grubu	Dönmeyen halat	Dönebilen halat
1Em	10	11.2
1Dm	11.2	12.5
1Cm	12.5	14
1Bm	14	16
1Am	16	18
2m	18	20
3m	20	22.4
4m	22.4	25
5m	25	28

Çıkış momenti	Redüktörün çıkışından alınan momenttir. Motorun ilettiği momentin, tahvil oranı ve verimle çarpılması ile hesaplanır.
Nominal güç (P) (kW)	Redüktörün ISO/FEM sınıfına göre belirlenen mekanik olarak taşıyabileceği güçtür. Performans tablolarında redüktörlerin nominal güçlerini bulabilirsiniz.
Çevrim oranı (i)	Redüktörde giriş ile çıkış devirlerinin birbirlerine oranıdır.
Müsaade edilen radyal yük F_{qam} (N)	Redüktörün çıkış milinde ki müsaade edilen radyal yüküdür.
Opsiyonlar	<ul style="list-style-type: none"> Tambur bağlantı flanşı Elektromanyetik fren çeşitleri Termistör Özel yağ ve keçeler Özel renk ve boya çeşitleri

Diğer opsiyon istekleri için fabrika ile temasa geçiniz.

Technical explanations

Hoist classification	Based on the state of loading and total duration of use, the hoist classifications (ISO 4300/1) can be listed as follow M1, M2, M3, M4, M5 and M6. The FEM(European federation of material handling) legislation 9.511/86 is defining technical standard from 1Dm to 5m.
State of loading	The state of loading is an indication of the frequency and magnitude of loads that a hoist can handle. This standard is composed of 4 categories Light – Moderate – Heavy – Very heavy.
Load capacity	Definition of the maximum load that a hoist can lift.
Hook path	The maximum distance between the hoist drum and the load.
Rope receiving arrangement	Rope receiving arrangement are calculate as $N/nh-h$
	N: Falls
	nh: Number of ropes
	h: Number of hook
	(The number of hook is generally defined as 1)
Drum diameter	The drum diameter can be calculated using the formula bellow:
	$DT = h1xd$
	DT: Drum diameter
	d: Cable wire diameter h1: Coefficient (Please consult the board bellow)

FEM Group	Non flexible rope	Standard rope
1Em	10	11.2
1Dm	11.2	12.5
1Cm	12.5	14
1Bm	14	16
1Am	16	18
2m	18	20
3m	20	22.4
4m	22.4	25
5m	25	28

Output torque	The output torque is the moment produced the gearbox. The calculation of the output torque is based on the electrical motor moment, the ratio and the efficiency.
Nominal power (P) (kW)	The maximum geared motor loads based on the ISO/FEM classifications. The full gearbox performance are available on the nominal loads board.
Ratio (i)	The ratio is defining the difference between the output and input speed.
Permissible overhung loads Fqam (N)	The maximum overhung capacity of the geared motor's output shaft.
Options	<ul style="list-style-type: none"> • Drum flange • Electromagnetic brake • Thermistor • Special oil and seals • Special paint and color configurations

For more options and configuration please contact directly our factory or local reseller.

Descriptions techniques

Classification de levage	La classification ISO 4300/1 distingue 6 catégories différentes M1, M2, M3, M4, M5 ET M6. Chaque catégorie est définie par les caractéristiques de la charge et la durée total d'utilisation. La législation 9.511/86 de la FEM (Fédération Européenne de la manutention) distingue 8 catégories allant de 1Dm à 5m.
Etat de sollicitation	L'état de sollicitation précise dans quelles proportions l'appareil de levage est utilisé à charge maximum ou à charge réduite. On distingue ainsi quatre états de sollicitation caractérisés : léger, moyen, lourd, très lourd.
Charge maximal	Définit la charge totale supportable par l'application de levage. Cette charge doit prendre en compte le câble et les différents accessoires sauf si ceux-ci sont d'un poids inférieur ou égal à 5%.
Distance au crochet	La distance maximale comprise entre le tambour et la charge à lever.
Configuration du câble	La configuration du câble N/nh-h
	N: Retombées
	nh: Nombre de câble
	h: Nombre de crochet
	(Le nombre de crochet est généralement défini par 1)
Diamètre du tambour	Le diamètre du tambour peut être calculer en utilisant la formule suivante:
	DT = h1xd DT: Diamètre du tambour d: Diamètre du câble h1: Coefficient (Consultez le tableau ci-dessous)

FEM Group	Câble non flexible	Câble standard
1Em	10	11.2
1Dm	11.2	12.5
1Cm	12.5	14
1Bm	14	16
1Am	16	18
2m	18	20
3m	20	22.4
4m	22.4	25
5m	25	28

Couple de sortie torque	Le couple de sortie défini le couple à la sortie du réducteur. Le couple de sortie est basé sur le couple moteur, le rapport de réducteur et l'efficiency du réducteur de la combinaison de pignons.
Puissance nominale (P) (kW)	La puissance nominale se base sur les charges définies par les classifications ISO/FEM. La puissance nominale des motoréducteurs est disponible dans le tableau de charge nominale.
Rapport de réduction (i)	Le rapport de réduction défini la différence entre la vitesse d'entrée et de sortie du motoréducteur.
Limite des charges radiales Fqam (N)	Valeur de la charge maximale applicable sur l'arbre de sortie du motoréducteur.
Options	<ul style="list-style-type: none"> • Diamètre du tambour • Frein électromagnétique • Thermisteur • Huiles et jointures spéciales • Couleurs et types de peintures optionnelles

For Pour plus d'informations contacter I-MAK Reduktor ou votre revendeur local, plus d'information via www.imakreduktor.com

Vinç sistemleri kaldırma redüktörü

Geared motor for hoisting drums / Motoréducteurs pour tambours de ponts roulants et grues

Kod	Tip tanımlama	Type designation	Spécifications des types
İRC...	Giriş milli	Solid input shaft	Avec arbre d'entrée
İRCM...	Motorlu	With motor	Avec moteur
İRCP...	IEC B5 pam flanşlı	IEC input flange	Avec bride PAM - IEC
İRCPM...	IEC B5 pam flanşlı motorlu	IEC input flange with motor	Avec bride PAM-IEC et moteur

Giriş opsiyonları

Input options / Options d'entrée



İRC
Giriş milli
Solid input shaft
Avec arbre de sortie



İRCM
Motorlu
With motor
Avec moteur



İRCP
IEC pam flanşlı
IEC input flange
Avec bride PAM - IEC



İRCPM
IEC pam flanşlı motorlu
IEC input flange with motor
Avec bride PAM-IEC et moteur

Redüktör opsiyonları / Gearboxes options / Options des motoréducteurs

Kod	Opsiyon	Options	Options
TBF	Tambur Bağlantı Flanşı	Drum Connection Flange	Bride de connexion du tambour

Motor opsiyonları / Motor's options / Options moteurs

Kod	Opsiyon	Options	Options
BR	Fren	Brake	Frein
BRH	Manuel kollu fren	Brake with hand release	Frein avec ouverture manuel
BD	Çift fren	Double brake	Double frein
BDH	Manuel kollu çift fren	Double brake with hand release	Double frein avec ouverture manuel
E	Enkoder	Encoder	Encoder
EMK	Elektromanyetik kavrama	Electromagnetic clutches	Disque électromagnétique
CF	Harici fan	External fan	Ventilation externe
M	Monofaze motor	Mono phase motor	Moteur monophasé

Çıkış mili / Output shaft / Arbre de sortie

Kod / Code	Varyasyon	Options	Options
111	Özel mil ölçüsü	Special shaft dimensions	Dimensions de l'arbre spécial
112	Özel mil malzemesi	Special shaft materials	Matériel de l'arbre spécial
113	Sertleştirilmiş mil	Hardened shaft	Axe durci
114	Diş çekilmiş mil	Screw	Axe à vis

Giriş mili - Pam mili / Input shaft / Arbre d'entrée

Kod / Code	Varyasyon	Options	Options
131	Özel mil ölçüsü	Dimensions of the shaft	Dimensions de l'arbre (Spécial)
132	Özel mil malzemesi	Material of special shaft	Matériaux de l'arbre (Spécial)
133	Sertleştirilmiş mil	Hardened steel shaft	Arbre en acier trempé
134	Çoklu kama uygulaması	Hollow shaft with screw	Arbre creux a vis
135	Özel alın mili	Spécial input shaft	Arbre d'entrée spécial
136	Diş çekilmiş mil	Shaft with screw	Arbre de sortie avec vis

Çıkış flanş / Output flange / Bride de sortie

Kod / Code	Varyasyon	Options	Options
141	Özel flanş ölçüsü	Dimensions of special output flange	Dimensions de la bride de sortie (Spéciale)
142	Özel flanş malzemesi	Material of special output flange	Matériaux de la bride de sortie (Spéciale)
143	Opsiyonel flanş	Optional output flange	Bride de sortie optionnelle
144	Standart dışı flanş*	Special output flange	Bride d'entrée spéciale

* İstenilen değişiklik ürünün standart flanş üzerinde yapılamayıp yeni bir flanş tasarlanması durumudur. / In the case your configuration require the production of a special flange / Dans le cas où la configuration de votre application requiert une bride d'entrée spéciale.

Giriş flanş / Input flange / Bride d'entrée

Kod / Code	Varyasyon	Options	Options
151	Özel flanş ölçüsü	Special input flange	Bride d'entrée (Spéciale)
152	Özel flanş malzemesi	Material of special input flange	Matériaux de la bride d'entrée (spéciale)
153	Standart dışı flanş*	Special output shaft	Bride de sortie spéciale

* İstenilen değişiklik ürünün standart flanş üzerinde yapılamayıp yeni bir flanş tasarlanması durumudur. / In the case your configuration require the production of a special flange / Dans le cas où la configuration de votre application requiert une bride de sortie spéciale.

Yağ / Oil / Huiles

Kod / Code	Varyasyon	Options	Options
211	Sentetik yağ VG 220 (SHC 630)	Synthetic oil VG 220 (SHC 630)	Huile synthétique VG 220 (SHC 630)
212	Gıda uyumlu yağ VG 220 (CIBUS 220)	Food compatible oil VG 220 (CIBUS 220)	Huile pour industrie agroalimentaire VG 220 (CIBUS 220)
213	-40C° Uyumlu yağ VG 220 (SHC 630)	Cold resistant oil -40C° VG 220 (SHC 630)	Huile base température -40C° VG220 (SHC 630)

Keçe-tapa / Seal-cover / Joint- bouchon

Kod / Code	Varyasyon	Options	Options
221	Özel ölçü keçe	Dimensions of special seal	Dimensions du joint (Spécial)
222	Özel ölçü tapa	Dimensions of special cover	Dimensions du bouchon (Spécial)
223	Özel marka keçe	Special brand of seal	Marque du joint (Spécial)
224	Özel marka tapa	Special brand of cover	Marque du bouchon (Spécial)
225	Viton keçe	Viton seal	Joint en viton
226	Özel tip keçe uygulaması	Special configuration of seal	Configuration spéciale du joint

Rulman / Bearing / Roulement

Kod / Code	Varyasyon	Options	Options
231	Güçlendirilmiş çıkış rulmanı	Reinforced output bearing	Roulement renforcé (Sortie)
232	Güçlendirilmiş giriş rulmanı	Reinforced input bearing	Roulement renforcée (Entrée)
233	Özel marka rulman	Special brand of bearing	Marque du roulement (Spécial)
234	Özel ölçü rulman	Special dimensions of bearing	Dimensions du roulement (Spécial)

Gövde / Housing / Carter

Kod / Code	Varyasyon	Options	Options
241	Özel işlenmiş gövde	Special housing	Carter spéciale
242	Özel malzeme	Special housing materials	Carter avec matériaux spéciaux

Boya / Paint / Peinture

Kod / Code	Varyasyon	Options	Options
251	Özel renk boya	Special paint color	Couleur spéciale
252	Özel tip boya	Special paint type	Type de peinture spéciale
253	Epoksi boya	Epoxy paint	Peinture epoxy
254	Akrilik boya (dış ortam)	Acrylic paint	Peinture acrylique (Environnement extérieur)
255	Su bazlı boya	Water based paint	Peinture à base d'eau
256	Antikorozif boya	Anti-corrosion paint	Peinture anti-corrosion

Dişli / Gears / Pignons

Kod / Code	Varyasyon	Options	Options
261*	Özel imalat dişli	Special gear	Pignons spéciaux
262	Katalog dışı tahvil	Gear ratio (Catalogue)	Rapport de réduction des pignons (Catalogue)

* 261 kodu, 262 yi kapsamaktadır. / 261 and 262 codes are equivalent / Les codes 261 et 262 sont équivalents

Voltaj - Frekans / Voltage and frequency / Voltage et fréquence

Kod / Code	Varyasyon	Options	Options
311	Özel voltaj motor	Special Voltage	Voltage spécial
312	Özel frekans motor	Special frequency	Fréquence spéciale

*400 V 50 Hz dışı tüm sarımlar standart dışı kabul edilir. / 400 V 50 Hz are considered as standard / 400 V 50 Hz sont les normes standards

Koruma sınıfı / IP Classification / Classification IP

Kod / Code	Varyasyon	Options	Options
321	IP 54	IP 54	IP 54
322	IP 56	IP 56	IP 56
323	IP 65	IP 65	IP 65
324	IP 66	IP 66	IP 66

IP 55 Standart kabul edilir / IP 55 is our standard / IP 55 étant la classe standard

İzolasyon sınıfı / Isolation class / Classe d'isolations

Kod / Code	Varyasyon	Options	Options
331	B sınıfı	B - class	Classe - B
332	H sınıfı	H - class	Classe - H

* F izolasyon sınıfı standart kabul edilir. / F class is accepted as a standard / La classe F étant la norme d'isolation standard

* 0 C° ile 40 C° aralığı dışındaki ortam sıcaklıklarını fabrikaya danışınız. / Adapted for outside environment with temperature in between 0 C° and 40 C° / Adapté aux environnements extérieurs avec une température comprises entre 0° C et 40° C

Rulman / Bearing / Roulement

Kod / Code	Varyasyon	Options	Options
341	Sıcak ortam rulmanı*	Bearing for hot environment	Roulement pour environnement a températures élevées
342	Soğuk ortam rulmanı*	Bearing for cold environment	Roulement pour environnement a températures négatives
343	İzole rulman	Isolated bearing	Roulement isolé
344	Gresörlük	Bearing with greasing nipples	Roulement avec graisseurs

* 0 C° ile 40 C° aralığı dışındaki ortam sıcaklıklarını fabrikaya danışınız / For outside environment with temperature out of 0C° and 40C° consult our technical team / Pour des environnements avec des température non comprises entre 0C° et 40C° consulté nos équipes techniques.

Marka / Brand / Marque

Kod / Code	Varyasyon	Options	Options
351	Gamak Motor	Gamak Motor	Gamak Moteur
352	Volt Elektrik Motor	Volt Motor	Volt Moteur
353	Aemot Motor	Aemot Motor	Aemot Moteur
354	Wat Motor	Wat Motor	Wat Moteur
356	Diğer	Diğer	Diğer

Verim sınıfı / Efficiency classifications / Classes d'efficience énergétique

Kod / Code	Varyasyon	Options	Options
361	IE1	IE1	IE1
362	IE3	IE3	IE3
363	IE4	IE4	IE4

* IE 2 verim sınıfı standart kabul edilir. / IE 2 is the standard category / IE 2 étant la norme standard

Fren markası / Brake's brand / Marque du frein

Kod / Code	Varyasyon	Options	Options
411	EMF fren	EMF brake	Frein - EMF
412	Fatih fren	Fatih brake	Frein - Fatih
413	Diğer	Other	Autres

Fren tipi / Type of brake / Type de frein

Kod / Code	Varyasyon	Options	Options
421	220 V soğutmalı	220 V cooler	220 V - avec refroidissement
422	24 V soğutmalı	24 V cooler	24 V - avec refroidissement
423	220 V soğutmasız*	220 V without cooler	220 V - sans refroidissement
424	24 V soğutmasız*	24 V without cooler	24 V - sans refroidissement
425	Çift balatalı fren	Double disk brake	Frein avec double disque
426	Özel tip fren	Special brake type	Type de frein spécial
427	Özel voltaj fren	Special voltage for brake	Frein avec voltage spécial

* Soğutmasız frenlerde motor fan muhafazası bulunmamaktadır / The brake without cooling are installed without fan or cover / Les freins sans refroidissement ne sont pas équipés de couvercle ou d'hélice.

Enkoder / Encoder / Codeur

Kod / Code	Varyasyon	Options	Options
431	HPL 100 Pulse rotary enkoder	HPL 100 Pulse rotary encoder	HPL 100 Codeur d'impulsions rotatif
432	HPL 360 Pulse rotary enkoder	HPL 360 Pulse rotary encoder	HPL 360 Codeur d'impulsions rotatif
433	HPL 500 Pulse rotary enkoder	HPL 500 Pulse rotary encoder	HPL 500 Codeur d'impulsions rotatif
434	HPL 1024 Pulse rotary enkoder	HPL 1024 Pulse rotary encoder	HPL 1024 Codeur d'impulsions rotatif
435	HPL 2048 Pulse rotary enkoder	HPL 2048 Pulse rotary encoder	HPL 2048 Codeur d'impulsions rotatif
436	HTL 1024 Pulse rotary enkoder	HTL 1024 Pulse rotary encoder	HTL 1024 Codeur d'impulsions rotatif
437	HTL 2048 Pulse rotary enkoder	HTL 2048 Pulse rotary encoder	HTL 2048 Codeur d'impulsions rotatif
438	TTL 1024 Pulse rotary enkoder	TTL 1024 Pulse rotary encoder	HTL 1024 Codeur d'impulsions rotatif
439	TTL 2048 Pulse rotary enkoder	TTL 2048 Pulse rotary encoder	TTL 2048 Codeur d'impulsions rotatif
440	Diğer	Others	Autres

* Diğer encoder çeşitleri için fabrikaya danışınız / For different type of encoder contact our sales team / Pour des type de codeurs différents contactez notre équipe technique

Termistör - Isıtıcı / Thermistor and heater / Thermistat et chauffage

Kod / Code	Varyasyon	Options	Options
441	PTC X 1 termistör	PTC X 1 thermistor	PTC X 1 Thermistat
442	Bimetal termostat	Bimetallic switch	Interrupteur bilame
443	Basınç sensörü	Pressure sensor	Senseur pression
444	110 V sargı ısıtıcı	110 V coil heat	Bobine chauffante 110 V
445	220 V sargı ısıtıcı	220 V coil heat	Bobine chauffante 220 V
446	PT 100	PT 100	PT 100

Harici fan / External fan / Hélice de refroidissement

Kod / Code	Varyasyon	Options	Options
451	24 VDC (EBM)	24 VDC (EBM)	24 VDC (EBM)
452	230 VAC (EBM)	230 VAC (EBM)	230 VAC (EBM)
453	380 VAC (EBM)	380 VAC (EBM)	380 VAC (EBM)
454	230 VAC	230 VAC	230 VAC
455	380 VAC	380 VAC	380 VAC

Özel motorlar / Special motor / Moteur spécial

Kod / Code	Varyasyon	Options	Options
461	Servo motor*	Servo motor	Servo moteur
462	DC motor*	DC motor	Moteur DC
463	Vektör motor	Vector motor	Moteur vecteur
464	Tork motoru	Tork motor	Moteur à couple élevé
465	Hidro motor*	Hydraulic motor	Moteur hydraulique
466	Pnömatik motor*	Compressed air motor	Moteur a air comprimé
467	Ex-proof motor	Explosion proof motor	Moteur anti-explosion
468	Senkron relüktans motor	Synchronous reluctance motors	Moteur à reluctance synchrone
469	Senkron motor*	Synchronous motors	Moteurs synchrones
470	Müşteri motoru	Customer's motor	Moteur en provenance du client

* Motorlar firmamız tarafından tedarik edilmemektedir / Our factory is not providing such motors / Moteur non fournis par notre usine

Özel motor kodları motorların fabrikamız tarafından takıldığı durumlarda uygulanır / Motors installed in our factory / Moteur installés dans notre usine

Frenler

1) Pervanesiz frenler

Elektrik motorunun arkasındaki soğutma kapağı takılmayarak bunların yerine monte edilen frenlerdir. Kısa süreli çalışan motorlarda bu tip frenler kullanılır.

2) Pervaneli frenler

Elektrik motorunun motor mili ve fan kapağı uzatılarak monte edilen frenlerdir. Devamlı çalışan motorlarda bu tip frenler kullanılır.

3) Mikro anahtarlı frenler

Elektrik motorlarının demeraj akımının yüksek olması ve freni açmada gecikmesi dolayısıyla istenmeyen durumlar meydana gelir. Bunları önlemek için, frenin üzerine konulan bir mikro anahtar vasıtasıyla freni açtıktan hemen sonra motorun çalışması sağlanır. Bu tip frenler özellikle büyük güçteki redüktörlerin elektrik motorları için uygundur.

Redüktörlerin ani veya gecikmeli frenlenmesi

Gecikmeli veya ani frenlenen redüktörler birçok sanayi makinalarında kullanılmaktadır. Bu sebepten frenler hem ani hem de gecikmeli fren yapacak şekilde dizayn edilmişlerdir. Frenlerin elektrik bağlantısında yapılacak bir değişiklikle ani veya gecikmeli frenleme sağlanır. Her frenli redüktör ile birlikte elektrik bağlantı şeması verilmektedir.

Frenli redüktörleri teslim aldığınızda fren bağlantısının gecikmeli olarak yapıldığını unutmayınız.

Brakes

1) Brakes without cooling fan

Brake which is mounted on fan side of electric motor by cancelling cooling fan and fan cover of motor. This type of brake is used for a short period running motors.

2) Brakes with cooling fan

Brake which is mounted on fan side of electric motor by extending motor shaft and fan cover to use fan. This type of brake is necessary for continuously running motors

3) Brakes with micro switch

Because of high starting current of motors delayed disengagement of magnetic brakes undesirable conditions occur. To prevent this situation, starting of motor is provided after disengagement of brake by means of brake by means of a micro switch installed on the brake. This type of brake is especially suitable for high power geared motors.

Non-delayed or delayed braking of geared motors

Delayed or non-delayed geared motors are used in many industrial machines. Therefore, brakes are designed to operate in both delayed and non-delayed conditions. This is supplied with each brake mounted geared motor.

Please do not forget that the brakes are connected for delayed operations standard.

Freins

1) Freins sans hélices de refroidissements

Freins montés directement à l'emplacement de l'hélice de refroidissement. Dans cette configuration l'hélice et le couvercle extérieur sont retirés. Ce type de configuration est conseillé pour les applications et moteurs avec une durée de fonctionnement réduite.

2) Freins avec hélice de refroidissement

Le frein est monté directement à l'arrière de l'emplacement de l'hélice de refroidissement. Ce type de configuration nécessite une prolongation de l'arbre d'entraînement du moteur. Ce type de configuration est conseillé pour les applications nécessitant un usage continu du frein.

3) Frein à ouverture manuelle

La forte charge appliquée par le moteur sur certains freins entraîne une prolongation de la période de blocage. Afin d'éviter un arrêt prolongé certains freins sont équipés d'un clé d'ouverture manuelle, cette option permet un redémarrage immédiat du moteur. Ce type de freins est particulièrement adapté aux moteurs à forte puissance.

Freins avec ou sans retardement d'arrêt.

Les motoréducteurs équipés de freins à retardement d'arrêt sont utilisés dans notre nombreuses applications et secteurs. Les freins sont conçus pour opérés avec ou sans l'option de retardement. Cette option est disponible pour l'ensemble de notre gamme de motoréducteurs. A noter que le freins dois être correctement connecté pour permettre un fonctionnement optimale de cette option.

Fren alıştırma Voltajları

Frenler 24V-DC veya 220V-AC ile çalışacak şekilde imal edilir. 220 voltluk frenlerin bağlantıları motor klemens kutusunda yapılmaktadır. 24V ile çalışan frenlerin bağlantısı için ayrıca 220/30V trafo ile doğrultucu gerekmektedir. İstenildiğinde bunlar firmamızca temin edilmektedir.

Frenli redüktörlerin elektrik motorlarına toprak hattı bağlantısı muhakkak yapılmalıdır.

Fren Siparişlerinde Belirtilmesi Gereken Hususlar

- 1) Fren Momenti
- 2) Fren Tipi
- 3) Fren voltajı

24V ile çalışan fren siparişlerinde trafolu doğrultucu istenip istenmediğini lütfen belirtiniz.

Fren bağlantı şemaları

Operating Voltage of Brakes

Brakes are manufactured to operate at 24V-DC or 220V-AC. 220V brakes are connected to the motor terminal box directly, but 220/30V transformer with rectifier unit needed for 24V operating brakes. This unit will be supplied if required.

Geared brake motors must be earthed.

Required Ordering Data for Brakes

- 1) Brake Torque
- 2) Brake Type
- 3) Brake Operating Voltage.

Please inform as if you need 220/30V transformer with rectifier unit for 24V operating brakes

Brake connection types

Voltage et Caractéristique des Freins

Les freins sont adaptés à un voltage de 24V-DC ou 220V-AC. Les freins fonctionnant sous 220V sont directement connectés à la boîte de Klemens, Les freins fonctionnant sous 24V doivent impérativement être couplés à un transformateur, cette unité est disponible en option.

Données Nécessaire à la Commande d'un Frein.

- 1) Couple des freins
- 2) Type de freins
- 3) Type de voltage

Veillez à nous informer si une unité de transformation 220/30V est nécessaire au branchement de votre frein (24 V)

Type de connexion des freins

Gecikmeli Frenleme (24V)

Delayed Running Brake (24V)
Frein à retardement (24 V)

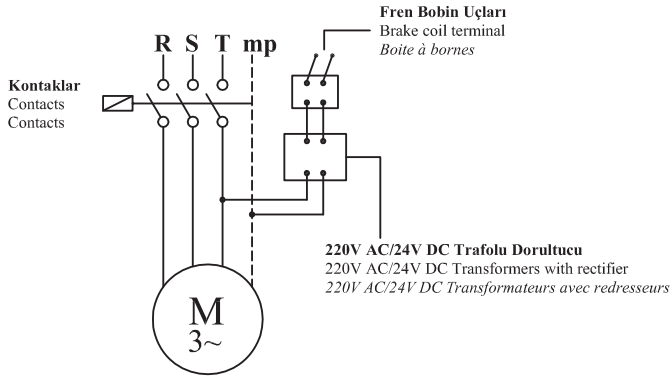

Ani Frenleme (24V)

Sudden Running Brake (24V)
Frein à arrêt immédiat (24 V)

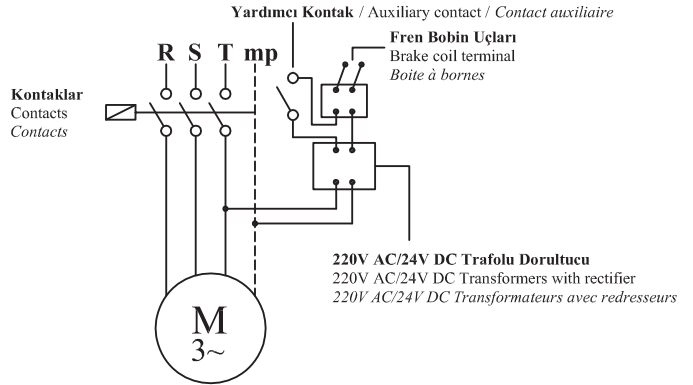

Gecikmeli Frenleme (220V)

Delayed Running Brake (220V)
Frein à retardement (220 V)

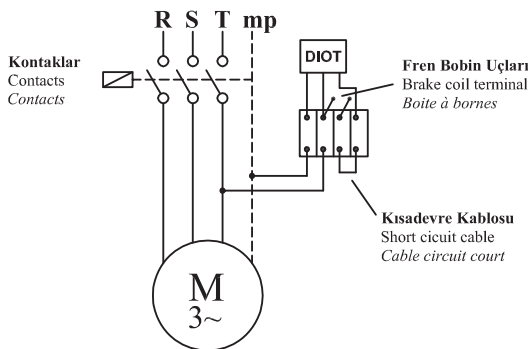

Ani Frenleme (220V)

Sudden Running Brake (220V)
Frein à arrêt immédiat (220 V)

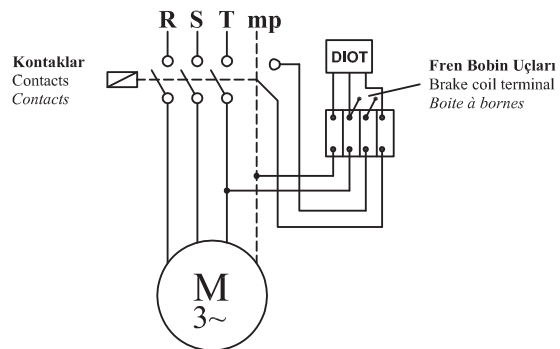

Tablo 1 / Table 1 / Tableau 1

Motor büyüklüğü Motor size Dimensions du moteur	n1 d/d / r.p.m / r.p.m			
	750	1000	1500	3000
	Güç / Power / Puissance [kW]			
63			0,12 - 0,18	0,18 - 0,25
71	0,09 - 0,12	0,18 - 0,28	0,25 - 0,37	0,37 - 0,55
80	0,18 - 0,25	0,37 - 0,55	0,55 - 0,75	0,75 - 1,1
90 S	0,37	0,75	1,1	1,5
90 L	0,55	1,1	1,5	2,2
100	0,75 - 1,1	1,5	2,2 - 3	3
112	1,5	2,2	4	4
132 S	2,2	3	5,5	5,5 - 7,5
132 M	3	4 - 5,5	7,5	11
160 M	4-5,5	7,5	11	15
160 L	7,5	11	15	18,5
180 M			18,5	22
180 L	11	15	22	
200	15	18,5 - 22	30	30 - 37
225 S	18,5		37	
225 M	22	30	45	45
250	30	37	55	55
280 S	37	45	75	75
280 M	45	55	90	90

Tablo 2 / Table 2 / Tableau 2

Motor büyüklüğü Motor size Dimensions du moteur	Fren momenti [kgm] Braking torque [kgm] Puissance de freinage [kgm]																			
	Hafif frenleme Light braking Freins légers										Kuvvetli frenleme Strong braking Freins lourds									
	0,5	1	2,5	4	5	10	20	30	50	80	0,5	1	2,5	4	5	10	20	30	50	80
63																				
71																				
80																				
90 S																				
90 L																				
100																				
112																				
132 S																				
132 M																				
160 M																				
160 L																				
180 M																				
180 L																				
200																				
225 S																				
225 M																				
250																				
280 S																				
280 M																				

Tambur bağlantı flanşı

İRC serisi vinç tamburu tahrik redüktörlerinin çıkış milleri DIN 5480 standartlarına göre çoklu kamalı olarak üretilmektedir. Aşağıdaki şekilde bağlantı şekli tarif edilmektedir. Tüm vinç tamburu tahrik redüktörleri için tambur bağlantı flanşı üretilmektedir.

Drum connection flange

The gearboxes of the IRC Series are mounted with a geared shaft based on DIN 5480 standards. All the models of the IRC Serie are mounted with flange adapted for standards drums. The mounting configuration is made as bellow.

Bride de connexion au tambour

Les réducteurs de la série IRC sont équipés d'arbre de sortie cannelés conformant aux normes DIN 5480. Tous les réducteurs de la série IRC sont fournis avec des brides adaptées aux tambours standards. La configuration de montage est représentée ci-dessous.

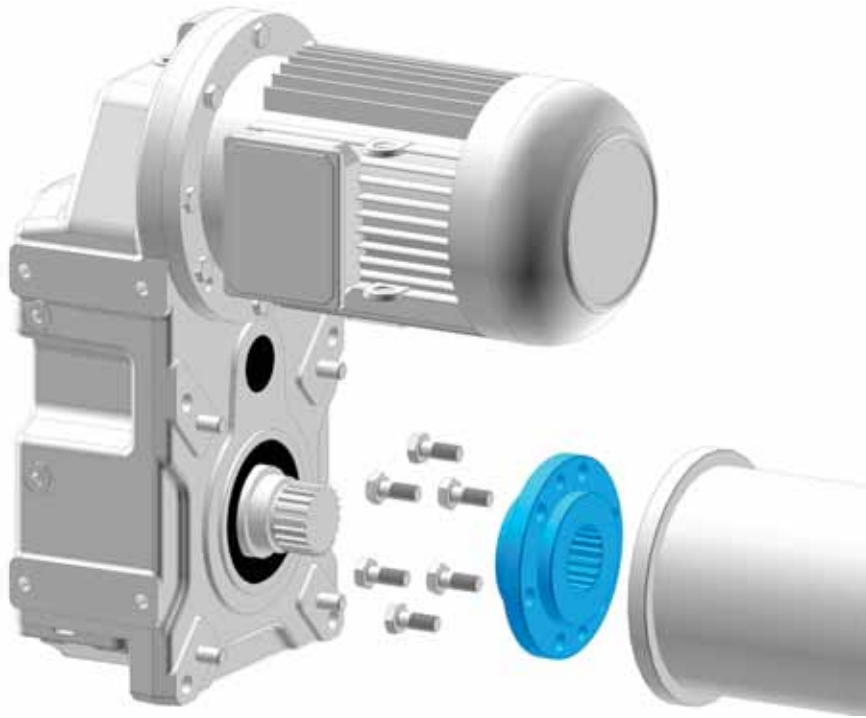
**İRC Serisi redüktör dönüş yönleri aşağıda ifade edilmiştir.**

The direction of rotation for the IRC gearboxes are listed bellow.

Les sens de rotation des motoréducteurs IRC sont listés ci-dessous



1	CCW (Saat yönünün tersi)
	Counter clock wise
	Sens anti horaire
2	CW (Saat Yönü)
	Clock wise
	Sens horaire

YAPI SINIFLANDIRMASI
ISO ve FEM 1 e göre

YÜKLEME SINIFI TABLOSU

Q4	Düzenli olarak nominal yükle yüklenen yapılar					
	Q3	Genellikle 1/3 ve 2/3 nominal yük arasında yüklenen ve sıklıkla nominal yüke maruz kalan yapılar				
		Q2	Genellikle 1/3 nominal yükle yüklenen ve nominal yüke nadiren maruz kalan yapılar			
			Q1	Genellikle çok hafif yüklerle yüklenen ve istisnai olarak nominal yüke maruz kalan yapılar		
A2 to A4	A1 to A3	A1 to A2	A1	U0 to U2	x 10 ⁴ 6,3	Düzenli olmayan nadir kullanım, uzun süren dinlenme periyotları
A5	A4	A3	A2	U3	12,5	
A6	A5	A4	A3	U4	25	Hafif hizmette düzenli kullanım
A7	A6	A5	A4	U5	50	Kesik kesik düzenli kullanım
A8	A7	A6	A5	U6	100	Yoğun olarak düzensiz kullanım
A8	A8	A7 to A8	A6 to A8	U7 to U8	400	Şiddetli yoğun düzensiz kullanım
Sınıflandırma: ISO ve FEM 1 standardına göre					Kaldırma çevrimi sayısı	Kullanım sınıfı

STRUCTURES CLASSIFICATION
ISO ve FEM 1 e göre

CLASS OF LOAD SPECTRUM

Q4	Structures regularly loaded close to nominal load					
	Q3	Structures lifting frequently enough the nominal load and usually loads between 1/3 and 2/3 of the nominal load				
		Q2	Structures lifting only seldom the nominal load and usually loads of about 1/3 of the nominal load			
			Q1	Structures exceptionally lifting the nominal load and usually very light loads		
A2 to A4	A1 to A3	A1 to A2	A1	U0 to U2	x 10 ⁴ 6,3	"Non-regular occasional use, followed by long rest periods"
A5	A4	A3	A2	U3	12,5	
A6	A5	A4	A3	U4	25	Regular in light service
A7	A6	A5	A4	U5	50	Regular use in intermittent service
A8	A7	A6	A5	U6	100	Irregular use in intensive service
A8	A8	A7 to A8	A6 to A8	U7 to U8	400	Use in severe intensive service
Classification : ISO FEM 1 standard					Number of lifting cycles	Class of use

CLASSEMENT DES APPAREILS
Suivant : ISO ou FEM section 1

CLASSE DE SPECTRE DE CHARGE

Q4	Appareils régulièrement chargés au voisinage de la charge maximale					
	Q3	Appareils levant assez fréquemment la charge charge maximale et couramment des charges comprises entre 1/3 et 2/3 de la charge maximale				
		Q2	Appareils ne soulevant que rarement la charge maximale et couramment des charges de l'ordre de 1/3 de la charge maximale			
			Q1	Appareils soulevant exceptionnellement la charge maximale et couramment des charges très faibles		
A2 to A4	A1 to A3	A1 to A2	A1	U0 to U2	x 10 ⁴ 6,3	Utilisation occasionnelle non régulière suivie de longues périodes de repos
A5	A4	A3	A2	U3	12,5	
A6	A5	A4	A3	U4	25	Utilisation régulière en service léger
A7	A6	A5	A4	U5	50	Utilisation régulière en service intermittent
A8	A7	A6	A5	U6	100	Utilisation irrégulière en service intensif
A8	A8	A7 to A8	A6 to A8	U7 to U8	400	Utilisation en service intensif sévère
Classement : norme ISO FEM 1					Nombre de cycles de levage	Classes d'utilisation

MEKANİZMA SINIFLANDIRMASI
FEM 9 a göre

KULLANIM SIKLIĞI SINIFI TABLOSU

L4				Düzenli olarak maksimum yükte kullanılan mekanizmalar veya mekanizma elemanları					4		
L3				Genellikle orta-ağır yüklerde kullanılan ve sıklıkla maksimum yüke maruz kalan mekanizmalar veya mekanizma elemanları					3		
L2				Genellikle 1/3 nominal yükle yüklenen ve nadiren nominal yüke maruz kalan mekanizmalar veya mekanizma elemanları					2		
L1				Genellikle çok hafif yüklerle yüklenen ve istisnai olarak nominal yüke maruz kalan mekanizmalar					1		
M3	M2	M1	-	T1	15 dakikanın altında	400 saat	V 0,12	-	1Dm	1Cm	1Bm
M4	M3	M2	M1	T2	15 dakika ile 30 dakika arası	800 saat	V 0,25	1Dm	1Cm	1Bm	1Am
M5	M4	M3	M2	T3	30 dakika ile 1 saat arası	1600 saat	V 0,50	1Cm	1Bm	1Am	2m
M6	M5	M4	M3	T4	1 saat ile 2 saat arası	3200 saat	V 1	1Bm	1Am	2m	3m
M7	M6	M5	M4	T5	2 saat ile 4 saat arası	6300 saat	V 2	1Am	2m	3m	4m
M8	M7	M6	M5	T6	4 saat ile 8 saat arası	12500 saat	V 3	2m	3m	4m	5m
-	M8	M7	M6	T7	8 saat ile 16 saat arası	25000 saat	V 4	3m	4m	5m	-
-	-	M8	M7	T8	16 saatten fazla	50000 saat	V 5	4m	5m	-	-
Her ISO standardına göre sınıflandırma				Günlük ortalama kullanım süresi		Toplam kullanım süresi		Her FEM kuralına göre sınıflandırma			
				Kullanım sınıfı							

MECHANISMS CLASSIFICATION
According to : FEM section 9

CLASS OF FREQUENCY OF USE SPECTRUM

L4				Mechanism or elements of mechanism subjected regularly to the frequencies of use close to the maximum frequency of use					4		
L3				Mechanism or elements of mechanism frequently subjected to the maximum frequency of use and usually to average frequencies of use					3		
L2				Mechanism or elements of mechanism subjected rather often to the maximum frequency of use and usually to low frequencies of use					2		
L1				Mechanism or elements of mechanism subjected exceptionally to the maximum frequency of use and usually to very low frequencies of use					1		
M3	M2	M1	-	T1	Under 0h15	400 heures	V 0,12	-	1Dm	1Cm	1Bm
M4	M3	M2	M1	T2	From 0h15 to 0h30	800 heures	V 0,25	1Dm	1Cm	1Bm	1Am
M5	M4	M3	M2	T3	From 0h30 to 1h00	1600 heures	V 0,50	1Cm	1Bm	1Am	2m
M6	M5	M4	M3	T4	From 1h00 to 2h00	3200 heures	V 1	1Bm	1Am	2m	3m
M7	M6	M5	M4	T5	From 2h00 to 4h00	6300 heures	V 2	1Am	2m	3m	4m
M8	M7	M6	M5	T6	From 4h00 to 8h00	12500 heures	V 3	2m	3m	4m	5m
-	M8	M7	M6	T7	From 8h00 to 16h00	25000 heures	V 4	3m	4m	5m	-
-	-	M8	M7	T8	au dessous de 16h00	50000 heures	V 5	4m	5m	-	-
Classification as per ISO standard				Average time supposed daily operation		Total duration of use		Classification as per FEM rules			
				Class of use							

CLASSEMENT DES MECANISMES
Basé sur les standards FEM section 9
CLASSE DE SPECTRE DE SOLLECITATION

L4				Mécánisme ou éléments de mécánisme soumis de façon régulière à des sollicitations voisines de la sollicitation maximale				4			
L3				Mécánisme ou éléments de mécánisme soumis fréquemment à la sollicitation maximale et couramment à des sollicitations moyennes				3			
L2				Mécánismes ou éléments de mécánisme soumis assez souvent à la sollicitation maximale et couramment à des sollicitations faibles				2			
L1				Mécánismes ou éléments de mécánisme soumis exceptionnellement à la sollicitation maximale et souvent à des sollicitations très faible				1			
M3	M2	M1	-	T1	de 0h15 à 0h30	400 heures	V 0,12	-	1Dm	1Cm	1Bm
M4	M3	M2	M1	T2	de 0h15 à 0h30	800 heures	V 0,25	1Dm	1Cm	1Bm	1Am
M5	M4	M3	M2	T3	de 0h15 à 1h00	1600 heures	V 0,50	1Cm	1Bm	1Am	2m
M6	M5	M4	M3	T4	de 1h00 à 2h00	3200 heures	V 1	1Bm	1Am	2m	3m
M7	M6	M5	M4	T5	de 2h00 à 4h00	6300 heures	V 2	1Am	2m	3m	4m
M8	M7	M6	M5	T6	de 4h00 à 8h00	12500 heures	V 3	2m	3m	4m	5m
-	M8	M7	M6	T7	de 8h00 à 16h00	25000 heures	V 4	3m	4m	5m	-
-	-	M8	M7	T8	au dessous de 16h00	50000 heures	V 5	4m	5m	-	-
Classement suivant norme ISO						Temps moyen de fonctionnement quotidien présumé	Durée totale d'utilisation	Classement suivant règles FEM			
						Classe d'utilisation					

Q1	Düzenli olarak nominal yükü yüklenen sistemler
Q2	Genellikle 1/3 ve 2/3 nominal yük arasında yüklenen ve sıklıkla nominal yüke maruz kalan sistemler
Q3	Genellikle 1/3 nominal yükü yüklenen ve nominal yüke nadiren maruz kalan sistemler
Q4	Genellikle çok hafif yüklerle yüklenen ve istisnai olarak nominal yüke maruz kalan sistemler

6,3	Düzenli olmayan nadir kullanım, uzun süren dinlenme periyotları
12,5	
25	Hafif hizmette düzenli kullanım
50	Kesik kesik düzenli kullanım
100	Yoğun olarak düzensiz kullanım
400	Şiddetli yoğun düzensiz kullanım

L4	Düzenli olarak maksimum kullanım sıklığına yakın sıklıkta kullanılan mekanizmalar veya mekanizma elemanları
L3	Genellikle ortalama kullanım sıklığında kullanılan ve sıklıkla maksimum kullanım sıklığında kullanılan mekanizmalar veya mekanizma elemanları
L2	Genellikle 1/3 nominal yükü yüklenen ve nominal yüke nadiren maruz kalan mekanizmalar veya mekanizma elemanları
L1	Genellikle çok hafif yüklerle yüklenen ve istisnai olarak nominal yüke maruz kalan mekanizmalar veya mekanizma elemanları

Vinç sınıflarının redüktör servis faktörü karşılaştırma tablosu

The service factor for the IRC Series gearboxes are defined by the board below / *Les facteurs service des réducteurs de la serie IRC se basent sur le tableau suivant*

Yükleme türü Loads charge	Servis Faktörleri / Service factor / Facteur service									
	T0	T1	T2	T3	T4	T5	T6	T7	T8	T9
L1 – Hafif L1 – Light L1 – Légère			0,4	0,5	0,6	0,7	0,8	0,9	1,1	1,4
L2 – Orta L2 – Moderate L2 – Modérée		0,4	0,5	0,6	0,7	0,8	0,9	1,1	1,4	
L3 – Ağır L3 – Heavy L3 – Elevée	0,4	0,5	0,6	0,7	0,8	0,9	1,1	1,4		
L4 – Çok ağır L4 – Very heavy L4 – Très levée	0,5	0,6	0,7	0,8	0,9	1,1	1,4			

ISO (FEM)	M1(1Dm)	M2(1Cm)	M3(1Bm)	M4(1Am)	M5(2m)	M6(3m)	M7(4m)	M8(5m)
fs	0,5>X>0	0,6>X>0,5	0,7>X>0,6	0,8>X>0,7	0,9>X>0,8	1,1>X>0,9	1,4>X>1,1	X>1,4

Redüktörlerin Kontrol ve Bakımları

- Redüktörlerin yağ seviyesi ve miktarını kontrol ediniz. Yağın cinsini İ.MAK kataloğunda yer alan yağ çizelgelerini kullanarak seçiniz.
- Havalandırma tapasının faal olup olmadığına bakınız. Hava tahliye deliği çalışmaz ise redüktör gövdesinin içinde biriken hava, basınç oluşturarak keçelerden yağ sızmasına sebep olur. Böylece yağ azalarak çevre kirliliğine yol açar ve redüktörün verimli çalışmasını engellemiş olur.
- Redüktör bağlantı cıvatalarının gevşeyip gevşemediğini kontrol ediniz, gevşeyen cıvatalar var ise sıkılmak suretiyle tedbir alınız. Redüktör montajında meydana gelen eksen kaçıklığında zararlı sarsıntılara dikkat ediniz.
- Redüktörün ilk çalıştırmadan 500 saat sonra, sonraki her 6000 saatte periyodik olarak yağını değiştiriniz.
- Özel hususlar ve çalışma şartları hakkında mutlaka firmamıza danışınız.

Control and maintenance gearboxes

- Check the oil levels and quantity of your gearboxes. Choose the type and quantity of oil from the İ.MAK catalogue.
- Check if the ventilation stopper is active or not. If the air evacuation hole does not work properly, the accumulated air in the gearbox trunk might causes pressure and gas leakage from the mats.
- Before starting your geared motors, proceed to the checking of connection bolts and screw. Check if they have loosened or not during transport or installation. Take measures by firming loosened bolts. A wrong connexion might create vibration to the axis and conduct to damage of the geared motor.
- Change the oil after 500 hours of initial operation and periodically every 6000 hours of operating the geared motor.
- If you are facing any technical issue, please consult the user guide delivered with the geared motor. In case of special issue or emergency please directly contact your reseller or the closest I-MAK technical center.

Contrôle et maintenance des réducteurs

- Vérifiez le niveau et la quantité d'huile de façons régulière. Consultez le catalogue I-MAK pour obtenir les niveaux d'huiles requis en fonction du modèle et de la position du réducteur.
- Vérifiez le fonctionnement de la valve d'aération. L'absence d'évacuation de l'air peut provoquer une augmentation de la pression dans le réducteur pouvant conduire à des fuites d'huiles.
- Contrôler les vis et boulons reliant le moteur au réducteur, en cas de mauvaise fermeture le moteur peut créer des vibrations de l'arbre entraînant l'endommagement du motoréducteur.
- La première vidange doit être effectuée après 500 heures d'utilisations du motoréducteur, les vidanges suivantes doivent être effectuées au bout de 6000 heures d'utilisations.
- En cas de problèmes techniques, consultez le manuel d'utilisation fournis à la livraison du motoréducteur. En cas de problèmes particulier ou d'urgence, veuillez à contacter votre revendeur ou le centre technique I-MAK le plus proche.

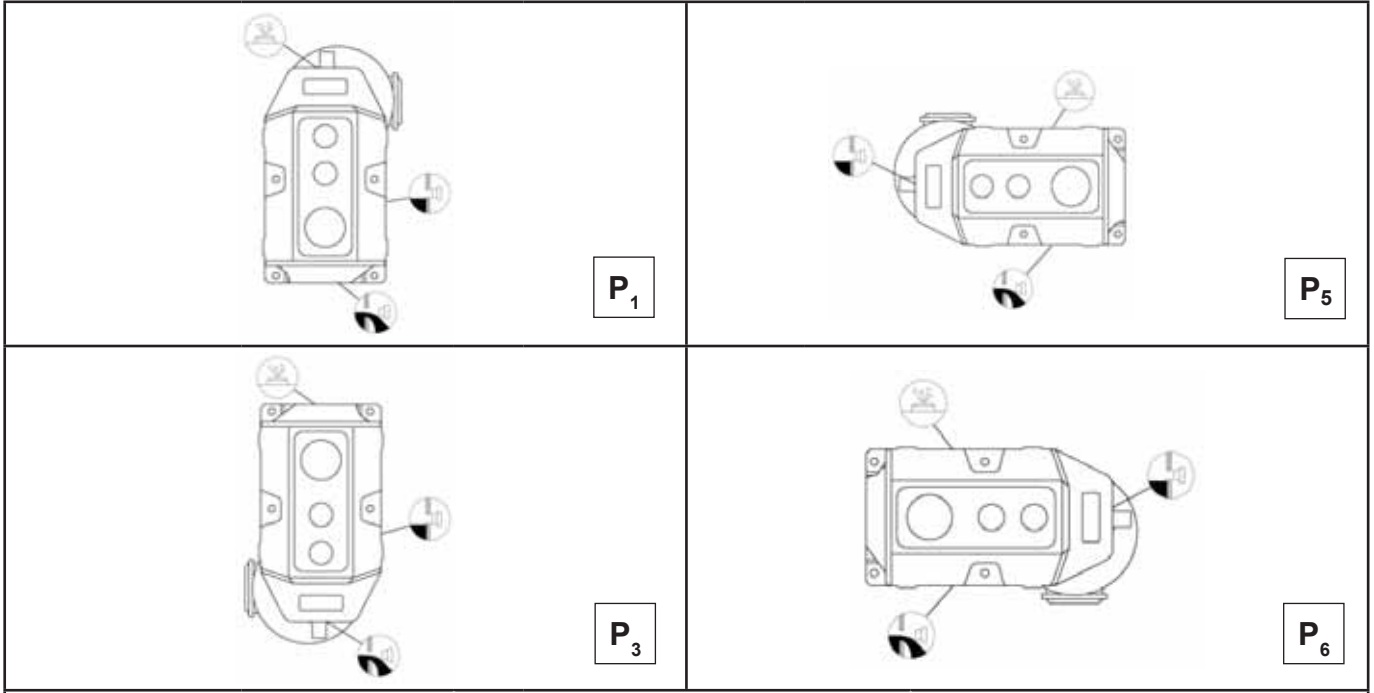

Yağ doldurma - Havalandırma
Vent plug
Valve d'aération



Yağ seviye tespit
Oil level
Niveau d'huile



Yağ boşaltma
Drain plug
Bouchon de drainage

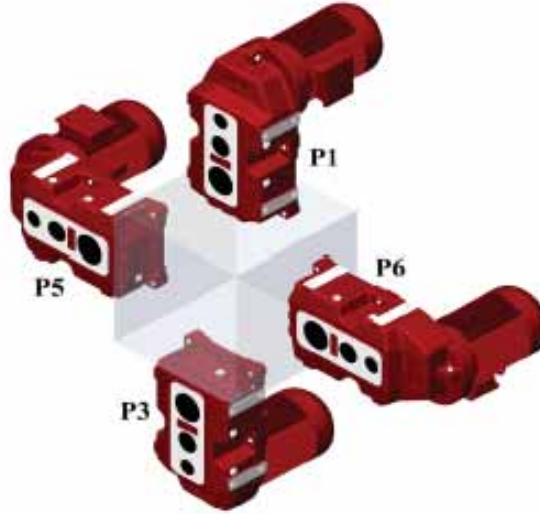

TİP Type Type	Bağlantı pozisyonları için yağ miktarları (litre) Oil quantities for mounting positions (liter) Quantités d'huiles en fonction de la position de montage (Litre)			
	P ₁	P ₃	P ₅	P ₆
İRCM 73	3,4	2,7	2,7	2,6
İRCM 83	4,6	4,2	4,4	4,2
İRCM 93	9,6	7,8	9,1	8,3
İRCM 103	18	15,3	18	18,5
İRCM 123	34	21	24	24

Motor Büyüklüğüne Göre Geometrik Mümkün Çevrim Oranları

Geometrically Possible Combinations of Ratios According to Motor Size / *Combinaisons de ratios possibles en fonction de la configuration moteur*



Tip Type	Motor büyüklüğü Motor size Taille du moteur									
	71	80	90	100	112	132	160	180	200	225
İRC73	65,25-120,79	26,29-120,79	23,83-120,79	23,83-86,63	23,83-41,85	23,83-26,29				
İRC83			27,54-133,51	27,54-133,51	27,54-75,61	27,54-54,36	27,54-33,00			
İRC93				31,19-162,83	31,19-162,83	31,19-162,83	31,19-79,84	31,19-34,03		
İRC103					51,91-199,48	51,91-199,48	51,91-177,28	51,91-95,90		
İRC123						45,83-198,33	45,83-198,33	45,85-134,47	45,83-84,26	45,83-64,40

Motor Büyüklüğüne Göre Geometrik Mümkün Çevrim Oranları
Geometrically Possible Combinations of Ratios According to Motor Size / *Combinaisons de ratios possibles en fonction de la configuration moteur*

Yağ Cinsi Lubrifiant Art des Lubrifiant	ISO Viskozite sınıfı Viscosity class Catégorie de viscosite	DIN 51517-3	Kullanım sıcaklığı Usage temperature Gebrauchs temperatur d'usage C°	Firma Firm Marque						
										
Mineral Yağ Mineral Oil Huile Minéral	ISO VG 320	CLP	0.....+100	Mobilgea XMP 320	Degol BG 320	Energol GR-XP 320	Omala F320	Alpha SP 320	GEM 1 320 N	Belgear M - 320 - süper
	ISO VG 220	CLP	-5.....+100	Mobilgea XMP 220	Degol BG 220	Energol GR-XP 220	Omala F220	Alpha SP 220	GEM 1 220 N	Belgear M - 220 - süper
	ISO VG 150	CLP	-5.....+100	Mobilgea XMP 150	Degol BG 150	Energol GR-XP 150	Omala 150	Alpha SP 150	GEM 1 150 N	Belgear M - 150 - süper
	ISO VG 100	CLP	-5.....+100	-	Degol BG 220	Energol GR-XP 220	Omala 100	Alpha SP 100	GEM 1 100 N	Belgear M - 100 - süper
Sentetik Yağ Synthetic Oil Huile Synthétique	ISO VG 320	CLP PG	-25.....+140	Gylgoyle 320	Degol GS 320	Energol SG-XP320	Tivela S 320	Alphasyn PG 320	Klübersynth GH 6-320	-
	ISO VG 220	CLP PG	-25.....+140	-	Degol GS 220	Energol SG-XP220	Tivela S 220	Alphasyn PG 220	Klübersynth GH 6-220	-
	ISO VG 150	CLP PG	-30.....+140	-	Degol GS 150	Energol SG-XP150	Tivela S 150	Alphasyn PG 150	Klübersynth GH 6-150	-
	ISO VG 100	CLP PG	-30.....+140	-	-	-	-	-	Klübersynth GH 6-100	-

Standart klemens pozisyonu "KP4" dir, aksi belirtilmediği sürece standart pozisyonunda yapılır.

The standard mounting position is "KP4", if the mounting position is not defined during the order, the mounting position is always "KP4"

La position de montage standard est "KP4", si aucune position de montage n'est précisée lors de la prise de commande, la position "KP4" sera attribuée par défaut.

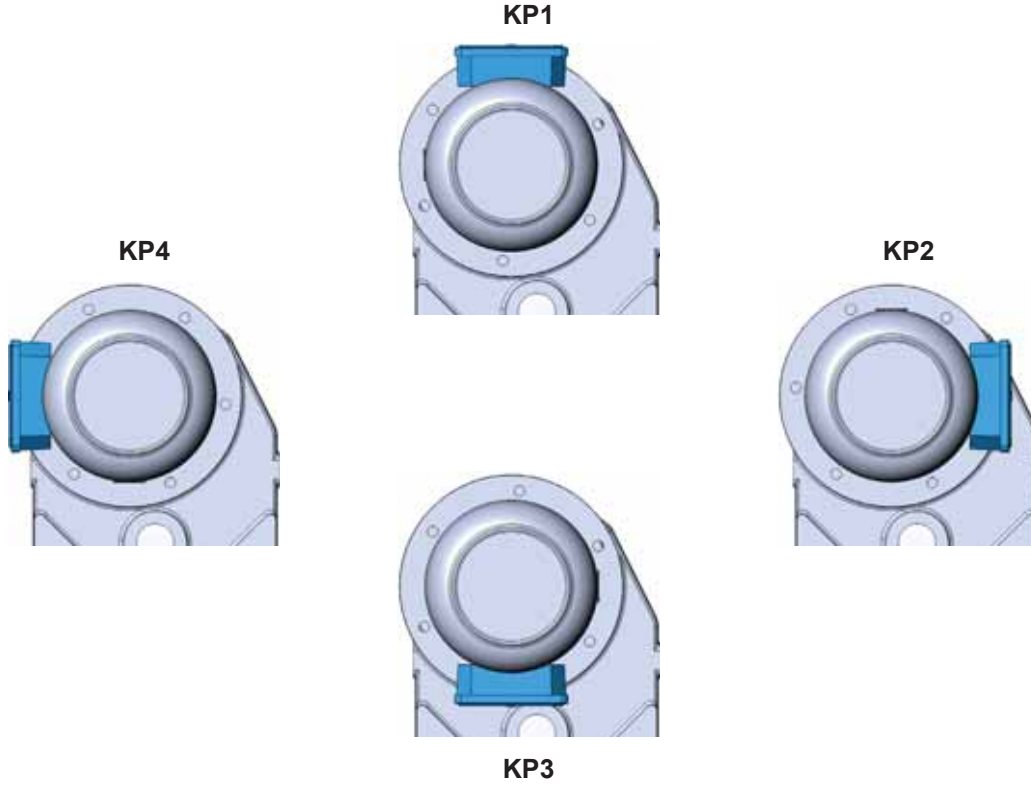
**Rakor yönleri**

Cable entry / Entrée des câbles

Standart rakor yönü "A" dir, aksi belirtilmediği sürece standart yönde yapılır.

The standard position of the cable entry is "A", if the position is not defined during the order, the mounting position is always "A"

La position standard de l'entrée des câbles est "A", si aucune position de montage n'est précisée lors de la prise de commande, la position "A" sera attribuée par défaut.

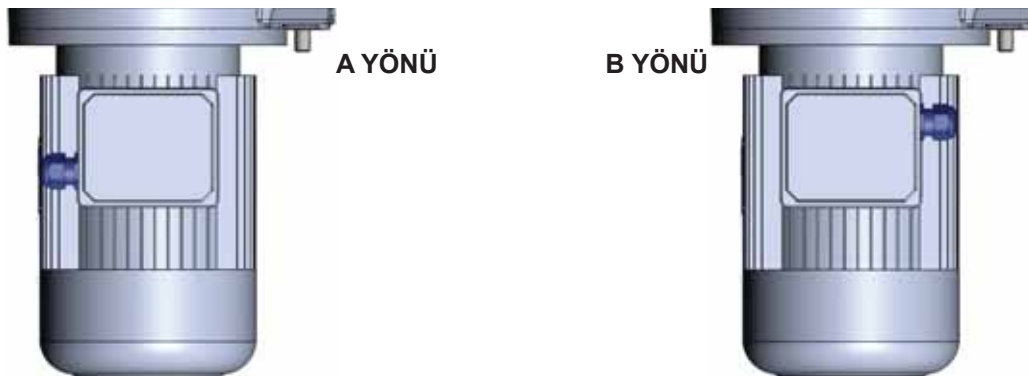

İRC	M	93	-	132	M	4	/	TBF	BR	CF	
Redüktör tipi / Gearbox type / Type de réducteur (İRC)	Giriş opsiyonu / Input option / Couple d'entrée (İRCM - İRCP - İRCPM)	Redüktör gövde büyüklüğü / Housing size / Taille du carter du réducteur (73 - 83 - 93 - 103 - 123)		Motor gövde büyüklüğü / Motor size / Taille du moteur (112 - 132 - 160 - 180)	Gövde uzunluğu / Frame length / Longueur du carter moteur (S - M - L)	Kutup sayısı / Pole number / Nombre de pôles (2 - 4 - 6 - 8)			Opsiyonlar / Options / Options		

1500 d/d Motorlar / Motors / Moteurs

Kod	Güç (KW)	Hız (d/d)	Anma Akımı	Moment (Nm)	Verim		IE Sınıfı	Çalışma Sınıfı
					100%	75%		
Code	Power (KW)	Speed (r.p.m.)	Rated Current	Torque (Nm)	Efficiency		IE Class	Duty Type
					100%	75%		
Code	Puissance (kW)	Vitesse (r.p.m.)	Ampère	Couple (Nm)	Efficience		Classe IE	Classe d'utilisation
					100%	75%		
63M4a	0,12	1365	0,41	0,84	57,1	57,1	IE1	S1
63M4b	0,18	1340	0,60	1,28	59,7	59,7	IE1	S1
C63M4	0,25	1350	0,95	1,77	60,7	60,7	IE1	S1
71M4a	0,25	1380	0,81	1,73	61,9	61,8	IE1	S1
71M4b	0,37	1390	1,15	2,54	68,1	68,1	IE1	S1
C71M4	0,55	1385	1,50	3,75	68,6	68,6	IE1	S1
80M4a	0,55	1365	1,60	3,85	69,1	69,0	IE1	S1
80M4b	0,75	1410	2,10	5,08	79,6	79,6	IE2	S1
90S4	1,1	1420	2,60	7,39	82,0	82,0	IE2	S1
90L4	1,5	1430	3,50	10,02	83,0	83,0	IE2	S1
C90L4	2,2	1435	5,00	14,60	84,4	84,5	IE2	S1
100L4a	2,2	1435	5,00	14,60	84,5	84,6	IE2	S1
100L4b	3	1435	6,60	20,00	85,5	85,7	IE2	S1
C100L4	4	1455	8,20	26,30	86,5	86,6	IE2	S1
112M4	4	1455	8,20	26,30	86,7	86,8	IE2	S1
132S4	5,5	1465	11,20	35,90	87,9	88,8	IE2	S1
132M4	7,5	1465	15,40	48,90	89,0	89,1	IE2	S1
C132M4	11	1465	21,00	71,70	89,9	90,0	IE2	S1
160M4	11	1465	21,00	71,70	90,0	90,1	IE2	S1
160L4	15	1465	29,80	97,80	90,6	90,7	IE2	S1
180M4	18,5	1470	34,50	120,00	91,3	91,4	IE2	S1
180L4	22	1470	42,50	143,00	91,7	91,4	IE2	S1
200L4	30	1470	55,00	195,00	92,5	92,6	IE2	S1
225S4	37	1470	67,00	240,00	92,7	92,7	IE2	S1
225M4	45	1470	80,00	292,00	93,3	93,3	IE2	S1

1000 d/d Motorlar / Motors / Moteurs

Kod	Güç (KW)	Hız (d/d)	Anma Akımı	Moment (Nm)	Verim		IE Sınıfı	Çalışma Sınıfı
					100%	75%		
Code	Power (KW)	Speed (r.p.m.)	Rated Current	Torque (Nm)	Efficiency		IE Class	Duty Type
					100%	75%		
Code	Puissance (kW)	Vitesse (r.p.m)	Ampère	Couple (Nm)	Efficience		Classe IE	Classe d'utilisation
					100%	75%		
71M6a	0,18	915	0,61	1,88	63,0	62,9	IE1	S1
71M6b	0,25	915	0,83	2,61	63,8	63,7	IE1	S1
80M6a	0,37	910	1,10	3,88	72,9	72,8	IE1	S1
80M6b	0,55	890	1,50	5,90	70,4	70,3	IE1	S1
90S6	0,75	920	2,00	7,79	75,9	75,9	IE2	S1
90L6	1,1	930	2,90	11,30	78,1	78,1	IE2	S1
100L6	1,5	945	3,60	15,20	79,8	79,7	IE2	S1
112M6	2,2	950	5,40	22,00	81,8	81,7	IE2	S1
132S6	3	960	6,90	29,80	83,3	83,2	IE2	S1
132M6a	4	960	9,00	39,80	84,6	84,5	IE2	S1
132M6b	5,5	960	12,30	54,70	86,0	86,0	IE2	S1
160M6	7,5	960	15,00	74,60	87,2	87,2	IE2	S1
160L6	11	965	22,00	108,90	88,7	88,7	IE2	S1
180L6	15	965	29,00	148,00	89,7	89,7	IE2	S1
200L6a	18,5	975	38,00	182,00	90,4	90,4	IE2	S1
200L6b	22	970	43,00	216,50	91,1	91,1	IE2	S1
225M6	30	980	58,00	292,00	91,7	91,7	IE2	S1
250M6	37	985	69,00	359,00	92,2	92,2	IE2	S1
250S6	45	985	92,00	436,00	92,7	92,7	IE2	S1

* Motor teknik değerleri GAMAK marka motorlar içindir, kullanılan diğer markalar için değişiklik gösterebilir.

		YERLİ MALİ BELGESİ Domestic goods certificate <i>Certificat de produit national</i>
		TÜRK STANDARTLARI ENSTİTÜSÜ KRİTERE UYGUNLUK BELGESİ Certificate of conformity to Turkish standards <i>Certificats de conformité aux standards Turcs</i>
		MARKA YENİLEME BELGESİ Certificate of trademark registration <i>Certificat d'enregistrement de marque</i>
		ISO 9001:2008 YÖNETİM SİSTEMİ ISO 9000:2008 Quality management system <i>ISO 9000:2008 : Systèmes de management de la qualité</i>
		ISO10002:2004 MÜŞTERİ MEMNUNİYETİ YÖNETİM SİSTEMİ ISO 10002:2004 Customer satisfaction management system <i>ISO 10002:2004 Management de la qualité - Satisfaction clients</i>
		OHSAS 18001:2007 İŞ SAĞLIĞI VE GÜVENLİĞİ YÖNETİM SİSTEMİ OHSAS 18001:2007 : Occupational health and safety management <i>OHSAS 18001:2007 : Management de la santé et de la sécurité au travail</i>
		AT UYGUNLUK BEYANI CE Declaration of conformity <i>Déclaration de conformité aux standards CE</i>
		EC TYPE EXAMINATION CERTIFICATE ATEX Certificate <i>Certificat ATEX</i>



Vinç Sistemleri Kaldırma Redüktörleri Güç ve Devir Tabloları

Power and Ratio Table for Hoisting Applications



Tableau de classification des couples et rapports de réduction pour les applications de levage



Vinç sistemleri kaldırma redüktörleri güç ve devir tabloları / Power and ratio table for hoisting applications / Tableau de classification des couples et rapports de réduction pour les applications de levage



D _T Tambur Çapı Drum Diameter <i>Diamètre de l'arbre</i> [mm]	V _h Kaldırma Hızı Lifting Speeds <i>Vitesse de levage</i> [m/min]	Vinç Sınıfı Crane Class <i>Classification de l'application de levage</i> ISO (FEM)	P ₁ Motor Gücü Power <i>Puissance</i> [kW]	n ₂ Çıkış Devri Output Speeds <i>Vitesse de sortie</i> [r.p.m]	i Tahvil Ratio <i>Rapport de réduction</i>	M ₂ Çıkış Momenti Output Torque <i>Couple de sortie</i>	Tip Type <i>Typ</i>		 kg
Ø110	4,1	M8 (5m)	0,37	12	120,792	291	IRCM 73 / 71 M 4b		
	4,5	M8 (5m)	0,55	13	107,423	385	IRCM 73 / 80 M 4a		
	5,2	M8 (5m)	0,55	15	96,194	345	IRCM 73 / 80 M 4a		
	5,5	M8 (5m)	0,55	16	86,628	311	IRCM 73 / 80 M 4a		
	6,6	M8 (5m)	0,75	19	73,889	361	IRCM 73 / 80 M 4b		
	7,3	M8 (5m)	0,75	21	65,252	319	IRCM 73 / 80 M 4b		
	8,3	M8 (5m)	0,75	24	57,996	284	IRCM 73 / 80 M 4b		
	9,3	M8 (5m)	1,1	27	51,846	372	IRCM 73 / 90 S 4a		
	11	M8 (5m)	1,1	33	41,848	300	IRCM 73 / 90 S 4a		
	13	M8 (5m)	1,5	39	35,564	348	IRCM 73 / 90 L 4a		
	15	M8 (5m)	1,5	44	32,098	314	IRCM 73 / 90 L 4a		
	18	M8 (5m)	2,2	53	26,291	377	IRCM 73 / 100 L 4a		
20	M8 (5m)	2,2	59	23,834	342	IRCM 73 / 100 L 4a			
Ø120	4,5	M8 (5m)	0,55	12	120,792	433	IRCM 73 / 80 M 4a		
	4,9	M8 (5m)	0,55	13	107,423	385	IRCM 73 / 80 M 4a		
	5,7	M8 (5m)	0,55	15	96,194	345	IRCM 73 / 80 M 4a		
	6,0	M8 (5m)	0,55	16	86,628	311	IRCM 73 / 80 M 4a		
	7,2	M8 (5m)	0,75	19	73,889	361	IRCM 73 / 80 M 4b		
	7,9	M8 (5m)	0,75	21	65,252	319	IRCM 73 / 80 M 4b		
	9,0	M8 (5m)	1,1	24	57,996	416	IRCM 73 / 90 S 4a		
	10	M8 (5m)	1,1	27	51,846	372	IRCM 73 / 90 S 4a		
	12	M8 (5m)	1,1	33	41,848	300	IRCM 73 / 90 S 4a		
	15	M8 (5m)	1,5	39	35,564	348	IRCM 73 / 90 L 4a		
	17	M8 (5m)	1,5	44	32,098	314	IRCM 73 / 90 L 4a		
	20	M8 (5m)	2,2	53	26,291	377	IRCM 73 / 100 L 4a		
22	M8 (5m)	2,2	59	23,834	342	IRCM 73 / 100 L 4a			
Ø130	4,9	M8 (5m)	0,55	12	120,792	433	IRCM 73 / 80 M 4a		
	5,3	M8 (5m)	0,55	13	107,423	385	IRCM 73 / 80 M 4a		
	6,1	M8 (5m)	0,55	15	96,194	345	IRCM 73 / 80 M 4a		
	6,5	M8 (5m)	0,75	16	86,628	424	IRCM 73 / 80 M 4b		
	7,8	M8 (5m)	0,75	19	73,889	361	IRCM 73 / 80 M 4b		
	8,6	M8 (5m)	0,75	21	65,252	319	IRCM 73 / 80 M 4b		
	9,8	M8 (5m)	1,1	24	57,996	416	IRCM 73 / 90 S 4a		
	11	M8 (5m)	1,1	27	51,846	372	IRCM 73 / 90 S 4a		
	13	M8 (5m)	1,5	33	41,848	409	IRCM 73 / 90 L 4a		
	16	M8 (5m)	1,5	39	35,564	348	IRCM 73 / 90 L 4a		
	18	M8 (5m)	2,2	44	32,098	461	IRCM 73 / 100 L 4a		
	22	M8 (5m)	2,2	53	26,291	377	IRCM 73 / 100 L 4a		
24	M8 (5m)	2,2	59	23,834	342	IRCM 73 / 100 L 4a			
Ø140	5,3	M8 (5m)	0,55	12	120,792	433	IRCM 73 / 80 M 4a		
	5,7	M8 (5m)	0,55	13	107,423	385	IRCM 73 / 80 M 4a		
	6,6	M8 (5m)	0,75	15	96,194	470	IRCM 73 / 80 M 4b		
	7,0	M8 (5m)	0,75	16	86,628	424	IRCM 73 / 80 M 4b		
	8,4	M8 (5m)	0,75	19	73,889	361	IRCM 73 / 80 M 4b		
	9,2	M8 (5m)	1,1	21	65,252	468	IRCM 73 / 90 S 4a		
	11	M8 (5m)	1,1	24	57,996	416	IRCM 73 / 90 S 4a		
	12	M8 (5m)	1,1	27	51,846	372	IRCM 73 / 90 S 4a		
	15	M8 (5m)	1,5	33	41,848	409	IRCM 73 / 90 L 4a		
	17	M8 (5m)	1,5	39	35,564	348	IRCM 73 / 90 L 4a		
	19	M8 (5m)	2,2	44	32,098	461	IRCM 73 / 100 L 4a		
	23	M8 (5m)	2,2	53	26,291	377	IRCM 73 / 100 L 4a		
26	M8 (5m)	3	59	23,834	466	IRCM 73 / 100 L 4b			





D _T Tambur Çapı Drum Diameter <i>Diamètre de l'arbre</i> [mm]	V _h Kaldırma Hızı Lifting Speeds <i>Vitesse de levage</i> [m/min]	Vinç Sınıfı Crane Class <i>Classification de l'application de levage</i> ISO (FEM)	P ₁ Motor Gücü Power <i>Puissance</i> [kW]	n ₂ Çıkış Devri Output Speeds <i>Vitesse de sortie</i> [r.p.m]	i Tahvil Ratio <i>Rapport de réduction</i>	M ₂ Çıkış Momenti Output Torque <i>Couple de sortie</i>	Tip Type <i>Typ</i>		 kg
Ø150	5,7	M8 (5m)	0,55	12	120,792	433	IRCM 73 / 80 M 4a		
	6,1	M8 (5m)	0,55	13	107,423	385	IRCM 73 / 80 M 4a		
	7,1	M8 (5m)	0,75	15	96,194	470	IRCM 73 / 80 M 4b		
	7,5	M8 (5m)	0,75	16	86,628	424	IRCM 73 / 80 M 4b		
	8,9	M8 (5m)	1,1	19	73,889	530	IRCM 73 / 90 S 4a		
	9,9	M8 (5m)	1,1	21	65,252	468	IRCM 73 / 90 S 4a		
	11	M8 (5m)	1,1	24	57,996	416	IRCM 73 / 90 S 4a		
	13	M8 (5m)	1,1	27	51,846	372	IRCM 73 / 90 S 4a		
	16	M8 (5m)	1,5	33	41,848	409	IRCM 73 / 90 L 4a		
	18	M8 (5m)	2,2	39	35,564	510	IRCM 73 / 100 L 4a		
	21	M8 (5m)	2,2	44	32,098	461	IRCM 73 / 100 L 4a		
	25	M8 (5m)	2,2	53	26,291	377	IRCM 73 / 100 L 4a		
Ø160	28	M8 (5m)	3	59	23,834	466	IRCM 73 / 100 L 4b		
	6,0	M8 (5m)	0,55	12	120,792	433	IRCM 73 / 80 M 4a		
	6,5	M8 (5m)	0,75	13	107,423	525	IRCM 73 / 80 M 4b		
	7,5	M8 (5m)	0,75	15	96,194	470	IRCM 73 / 80 M 4b		
	8,0	M8 (5m)	0,75	16	86,628	424	IRCM 73 / 80 M 4b		
	9,5	M8 (5m)	1,1	19	73,889	530	IRCM 73 / 90 S 4a		
	11	M8 (5m)	1,1	21	65,252	468	IRCM 73 / 90 S 4a		
	12	M8 (5m)	1,1	24	57,996	416	IRCM 73 / 90 S 4a		
	14	M8 (5m)	1,5	27	51,846	507	IRCM 73 / 90 L 4a		
	17	M8 (5m)	1,5	33	41,848	409	IRCM 73 / 90 L 4a		
	20	M8 (5m)	2,2	39	35,564	510	IRCM 73 / 100 L 4a		
	22	M8 (5m)	2,2	44	32,098	461	IRCM 73 / 100 L 4a		
Ø170	27	M8 (5m)	3	53	26,291	514	IRCM 73 / 100 L 4b		
	30	M8 (5m)	3	59	23,834	466	IRCM 73 / 100 L 4b		
	6,4	M8 (5m)	0,75	12	120,792	591	IRCM 73 / 80 M 4b		
	6,9	M8 (5m)	0,75	13	107,423	525	IRCM 73 / 80 M 4b		
	8,0	M8 (5m)	0,75	15	96,194	470	IRCM 73 / 80 M 4b		
	8,5	M8 (5m)	0,75	16	86,628	424	IRCM 73 / 80 M 4b		
	10	M8 (5m)	1,1	19	73,889	530	IRCM 73 / 90 S 4a		
	11	M8 (5m)	1,1	21	65,252	468	IRCM 73 / 90 S 4a		
	13	M8 (5m)	1,5	24	57,996	567	IRCM 73 / 90 L 4a		
	14	M8 (5m)	1,5	27	51,846	507	IRCM 73 / 90 L 4a		
	18	M8 (5m)	2,2	33	41,848	600	IRCM 73 / 100 L 4a		
	21	M8 (5m)	2,2	39	35,564	510	IRCM 73 / 100 L 4a		
Ø180	23	M8 (5m)	2,2	44	32,098	461	IRCM 73 / 100 L 4a		
	28	M8 (5m)	3	53	26,291	514	IRCM 73 / 100 L 4b		
	31	M8 (5m)	3	59	23,834	466	IRCM 73 / 100 L 4b		
	6,8	M8 (5m)	0,75	12	120,792	591	IRCM 73 / 80 M 4b		
	7,3	M8 (5m)	0,75	13	107,423	525	IRCM 73 / 80 M 4b		
	8,5	M8 (5m)	0,75	15	96,194	470	IRCM 73 / 80 M 4b		
	9,0	M8 (5m)	1,1	16	86,628	621	IRCM 73 / 90 S 4a		
	11	M8 (5m)	1,1	19	73,889	530	IRCM 73 / 90 S 4a		
	12	M8 (5m)	1,1	21	65,252	468	IRCM 73 / 90 S 4a		
	14	M8 (5m)	1,5	24	57,996	567	IRCM 73 / 90 L 4a		
	15	M8 (5m)	1,5	27	51,846	507	IRCM 73 / 90 L 4a		
	19	M8 (5m)	2,2	33	41,848	600	IRCM 73 / 100 L 4a		
22	M8 (5m)	2,2	39	35,564	510	IRCM 73 / 100 L 4a			
25	M8 (5m)	2,2	44	32,098	461	IRCM 73 / 100 L 4a			
30	M8 (5m)	3	53	26,291	514	IRCM 73 / 100 L 4b			
33	M8 (5m)	3	59	23,834	466	IRCM 73 / 100 L 4b			



Vinç sistemleri kaldırma redüktörleri güç ve devir tabloları / Power and ratio table for hoisting applications / Tableau de classification des couples et rapports de réduction pour les applications de levage

D _T Tambur Çapı Drum Diameter <i>Diamètre de l'arbre</i> [mm]	V _h Kaldırma Hızı Lifting Speeds <i>Vitesse de levage</i> [m/min]	Vinç Sınıfı Crane Class <i>Classification de l'application de levage</i> ISO (FEM)	P ₁ Motor Gücü Power <i>Puissance</i> [kW]	n ₂ Çıkış Devri Output Speeds <i>Vitesse de sortie</i> [r.p.m]	i Tahvil Ratio <i>Rapport de réduction</i>	M ₂ Çıkış Momenti Output Torque <i>Couple de sortie</i>	Tip Type <i>Typ</i>		 kg
Ø110	4,1	M8 (5m)	0,55	12	120,792	433	IRCM 73 / 80 M 4a		
	4,5	M8 (5m)	0,75	13	107,423	525	IRCM 73 / 80 M 4b		
	5,2	M8 (5m)	0,75	15	96,194	470	IRCM 73 / 80 M 4b		
	5,5	M8 (5m)	0,75	16	86,628	424	IRCM 73 / 80 M 4b		
	6,6	M8 (5m)	1,1	19	73,889	530	IRCM 73 / 90 S 4a		
	7,3	M8 (5m)	1,1	21	65,252	468	IRCM 73 / 90 S 4a		
	8,3	M8 (5m)	1,1	24	57,996	416	IRCM 73 / 90 S 4a		
	9,3	M8 (5m)	1,5	27	51,846	507	IRCM 73 / 90 L 4a		
	11	M8 (5m)	1,5	33	41,848	409	IRCM 73 / 90 L 4a		
	13	M8 (5m)	2,2	39	35,564	510	IRCM 73 / 100 L 4a		
	15	M8 (5m)	2,2	44	32,098	461	IRCM 73 / 100 L 4a		
	18	M8 (5m)	3	53	26,291	514	IRCM 73 / 100 L 4b		
20	M8 (5m)	3	59	23,834	466	IRCM 73 / 100 L 4b			
Ø120	4,5	M8 (5m)	0,75	12	120,792	591	IRCM 73 / 80 M 4b		
	4,9	M8 (5m)	0,75	13	107,423	525	IRCM 73 / 80 M 4b		
	5,7	M8 (5m)	0,75	15	96,194	470	IRCM 73 / 80 M 4b		
	6,0	M8 (5m)	1,1	16	86,628	621	IRCM 73 / 90 S 4a		
	7,2	M8 (5m)	1,1	19	73,889	530	IRCM 73 / 90 S 4a		
	7,9	M8 (5m)	1,1	21	65,252	468	IRCM 73 / 90 S 4a		
	9,0	M8 (5m)	1,5	24	57,996	567	IRCM 73 / 90 L 4a		
	10	M8 (5m)	1,5	27	51,846	507	IRCM 73 / 90 L 4a		
	12	M8 (5m)	2,2	33	41,848	600	IRCM 73 / 100 L 4a		
	15	M8 (5m)	2,2	39	35,564	510	IRCM 73 / 100 L 4a		
	17	M8 (5m)	2,2	44	32,098	461	IRCM 73 / 100 L 4a		
	20	M8 (5m)	3	53	26,291	514	IRCM 73 / 100 L 4b		
22	M8 (5m)	3	59	23,834	466	IRCM 73 / 100 L 4b			
Ø130	4,9	M8 (5m)	0,75	12	120,792	591	IRCM 73 / 80 M 4b		
	5,3	M8 (5m)	0,75	13	107,423	525	IRCM 73 / 80 M 4b		
	6,1	M8 (5m)	1,1	15	96,194	690	IRCM 73 / 90 S 4a		
	6,5	M8 (5m)	1,1	16	86,628	621	IRCM 73 / 90 S 4a		
	7,8	M8 (5m)	1,1	19	73,889	530	IRCM 73 / 90 S 4a		
	8,6	M8 (5m)	1,5	21	65,252	638	IRCM 73 / 90 L 4a		
	9,8	M8 (5m)	1,5	24	57,996	567	IRCM 73 / 90 L 4a		
	11	M8 (5m)	1,5	27	51,846	507	IRCM 73 / 90 L 4a		
	13	M8 (5m)	2,2	33	41,848	600	IRCM 73 / 100 L 4a		
	16	M8 (5m)	2,2	39	35,564	510	IRCM 73 / 100 L 4a		
	18	M8 (5m)	3	44	32,098	628	IRCM 73 / 100 L 4b		
	22	M8 (5m)	3	53	26,291	514	IRCM 73 / 100 L 4b		
24	M8 (5m)	4	59	23,834	622	IRCM 73 / 112 M 4b			
Ø140	5,3	M8 (5m)	0,75	12	120,792	591	IRCM 73 / 80 M 4b		
	5,7	M8 (5m)	0,75	13	107,423	525	IRCM 73 / 80 M 4b		
	6,6	M8 (5m)	1,1	15	96,194	690	IRCM 73 / 90 S 4a		
	7,0	M8 (5m)	1,1	16	86,628	621	IRCM 73 / 90 S 4a		
	8,4	M8 (5m)	1,1	19	73,889	530	IRCM 73 / 90 S 4a		
	9,2	M8 (5m)	1,5	21	65,252	638	IRCM 73 / 90 L 4a		
	11	M8 (5m)	1,5	24	57,996	567	IRCM 73 / 90 L 4a		
	12	M8 (5m)	2,2	27	51,846	744	IRCM 73 / 100 L 4a		
	15	M8 (5m)	2,2	33	41,848	600	IRCM 73 / 100 L 4a		
	17	M8 (5m)	3	39	35,564	696	IRCM 73 / 100 L 4b		
	19	M7 (4m)	3	44	32,098	628	IRCM 73 / 100 L 4b		
	23	M7 (4m)	4	53	26,291	686	IRCM 73 / 112 M 4b		
26	M7 (4m)	4	59	23,834	622	IRCM 73 / 112 M 4b			



D _T Tambur Çapı Drum Diameter <i>Diamètre de l'arbre</i> [mm]	V _h Kaldırma Hızı Lifting Speeds <i>Vitesse de levage</i> [m/min]	Vinç Sınıfı Crane Class <i>Classification de l'application de levage</i> ISO (FEM)	P ₁ Motor Gücü Power <i>Puissance</i> [kW]	n ₂ Çıkış Devri Output Speeds <i>Vitesse de sortie</i> [r.p.m]	i Tahvil Ratio <i>Rapport de réduction</i>	M ₂ Çıkış Momenti Output Torque <i>Couple de sortie</i>	Tip Type <i>Typ</i>		 kg
Ø150	5,7	M8 (5m)	0,75	12	120,792	591	IRCM 73 / 80 M 4b		
	6,1	M8 (5m)	1,1	13	107,423	771	IRCM 73 / 90 S 4a		
	7,1	M7 (4m)	1,1	15	96,194	690	IRCM 73 / 90 S 4a		
	7,5	M7 (4m)	1,1	16	86,628	621	IRCM 73 / 90 S 4a		
	8,9	M7 (4m)	1,5	19	73,889	723	IRCM 73 / 90 L 4a		
	9,9	M7 (4m)	1,5	21	65,252	638	IRCM 73 / 90 L 4a		
	11	M7 (4m)	1,5	24	57,996	567	IRCM 73 / 90 L 4a		
	13	M7 (4m)	2,2	27	51,846	744	IRCM 73 / 100 L 4a		
	16	M7 (4m)	2,2	33	41,848	600	IRCM 73 / 100 L 4a		
	18	M7 (4m)	3	39	35,564	696	IRCM 73 / 100 L 4b		
	21	M7 (4m)	3	44	32,098	628	IRCM 73 / 100 L 4b		
	25	M7 (4m)	4	53	26,291	686	IRCM 73 / 112 M 4b		
Ø160	28	M7 (4m)	4	59	23,834	622	IRCM 73 / 112 M 4b		
	6,0	M7 (4m)	1,1	12	120,792	866	IRCM 73 / 90 S 4a		
	6,5	M7 (4m)	1,1	13	107,423	771	IRCM 73 / 90 S 4a		
	7,5	M7 (4m)	1,1	15	96,194	690	IRCM 73 / 90 S 4a		
	8,0	M7 (4m)	1,1	16	86,628	621	IRCM 73 / 90 S 4a		
	9,5	M7 (4m)	1,5	19	73,889	723	IRCM 73 / 90 L 4a		
	11	M7 (4m)	1,5	21	65,252	638	IRCM 73 / 90 L 4a		
	12	M7 (4m)	2,2	24	57,996	832	IRCM 73 / 100 L 4a		
	14	M7 (4m)	2,2	27	51,846	744	IRCM 73 / 100 L 4a		
	17	M7 (4m)	2,2	33	41,848	600	IRCM 73 / 100 L 4a		
	20	M7 (4m)	3	39	35,564	696	IRCM 73 / 100 L 4b		
	22	M7 (4m)	3	44	32,098	628	IRCM 73 / 100 L 4b		
Ø170	27	M7 (4m)	4	53	26,291	686	IRCM 73 / 112 M 4b		
	30	M7 (4m)	4	59	23,834	622	IRCM 73 / 112 M 4b		
	6,4	M7 (4m)	1,1	12	120,792	866	IRCM 73 / 90 S 4a		
	6,9	M7 (4m)	1,1	13	107,423	771	IRCM 73 / 90 S 4a		
	8,0	M7 (4m)	1,1	15	96,194	690	IRCM 73 / 90 S 4a		
	8,5	M7 (4m)	1,5	16	86,628	847	IRCM 73 / 90 L 4a		
	10	M7 (4m)	1,5	19	73,889	723	IRCM 73 / 90 L 4a		
	11	M7 (4m)	1,5	21	65,252	638	IRCM 73 / 90 L 4a		
	13	M7 (4m)	2,2	24	57,996	832	IRCM 73 / 100 L 4a		
	14	M7 (4m)	2,2	27	51,846	744	IRCM 73 / 100 L 4a		
	18	M7 (4m)	3	33	41,848	819	IRCM 73 / 100 L 4b		
	21	M7 (4m)	3	39	35,564	696	IRCM 73 / 100 L 4b		
Ø180	23	M7 (4m)	4	44	32,098	837	IRCM 73 / 112 M 4b		
	28	M6 (3m)	4	53	26,291	686	IRCM 73 / 112 M 4b		
	31	M6 (3m)	5,5	59	23,834	855	IRCM 73 / 132 S 4c		
	6,8	M7 (4m)	1,1	12	120,792	866	IRCM 73 / 90 S 4a		
	7,3	M7 (4m)	1,1	13	107,423	771	IRCM 73 / 90 S 4a		
	8,5	M7 (4m)	1,1	15	96,194	690	IRCM 73 / 90 S 4a		
	9,0	M7 (4m)	1,5	16	86,628	847	IRCM 73 / 90 L 4a		
	11	M7 (4m)	1,5	19	73,889	723	IRCM 73 / 90 L 4a		
	12	M7 (4m)	2,2	21	65,252	936	IRCM 73 / 100 L 4a		
	14	M7 (4m)	2,2	24	57,996	832	IRCM 73 / 100 L 4a		
	15	M7 (4m)	2,2	27	51,846	744	IRCM 73 / 100 L 4a		
	19	M6 (3m)	3	33	41,848	819	IRCM 73 / 100 L 4b		
22	M6 (3m)	3	39	35,564	696	IRCM 73 / 100 L 4b			
25	M6 (3m)	4	44	32,098	837	IRCM 73 / 112 M 4b			
30	M6 (3m)	4	53	26,291	686	IRCM 73 / 112 M 4b			



Vinç sistemleri kaldırma redüktörleri güç ve devir tabloları / Power and ratio table for hoisting applications / Tableau de classification des couples et rapports de réduction pour les applications de levage



D _T Tambur Çapı Drum Diameter Diamètre de l'arbre [mm]	V _h Kaldırma Hızı Lifting Speeds Vitesse de levage [m/min]	Vinç Sınıfı Crane Class Classification de l'application de levage ISO (FEM)	P ₁ Motor Gücü Power Puissance [kW]	n ₂ Çıkış Devri Output Speeds Vitesse de sortie [r.p.m]	i Tahvil Ratio Rapport de réduction	M ₂ Çıkış Momenti Output Torque Couple de sortie	Tip Type Typ			kg
Ø170	4,6	M8 (5m)	1,1	8,6	162,826	1168	IRCM 93 / 90 S 4a			
	5,1	M8 (5m)	1,1	9,5	146,946	1054	IRCM 93 / 90 S 4a			
	5,3	M8 (5m)	1,1	10	133,419	957	IRCM 93 / 90 S 4a			
	6,9	M8 (5m)	1,5	13	111,602	1092	IRCM 93 / 90 L 4a			
	8,5	M8 (5m)	1,5	16	87,936	860	IRCM 93 / 90 L 4a			
	9,6	M8 (5m)	2,2	18	79,841	1145	IRCM 93 / 100 L 4a			
	11	M8 (5m)	2,2	21	66,785	958	IRCM 93 / 100 L 4a			
	12	M8 (5m)	2,2	23	61,444	882	IRCM 93 / 100 L 4a			
	14	M8 (5m)	3	26	54,545	1067	IRCM 93 / 100 L 4b			
	17	M8 (5m)	3	31	44,753	876	IRCM 93 / 100 L 4b			
	20	M8 (5m)	4	38	37,199	970	IRCM 93 / 112 M 4b			
	22	M8 (5m)	4	41	34,034	888	IRCM 93 / 112 M 4b			
	24	M8 (5m)	5,5	45	31,194	1119	IRCM 93 / 132 S 4c			
	5,3	M8 (5m)	1,1	10	133,509	958	IRCM 83 / 90 S 4a			
	6,4	M8 (5m)	1,5	12	121,711	1191	IRCM 83 / 90 L 4a			
	7,5	M8 (5m)	1,5	14	102,407	1002	IRCM 83 / 90 L 4a			
	8,0	M8 (5m)	1,5	15	92,330	903	IRCM 83 / 90 L 4a			
	10	M8 (5m)	2,2	19	75,613	1085	IRCM 83 / 100 L 4a			
	12	M8 (5m)	2,2	23	60,299	865	IRCM 83 / 100 L 4a			
	14	M8 (5m)	3	26	54,358	1063	IRCM 83 / 100 L 4b			
15	M8 (5m)	3	29	48,314	945	IRCM 83 / 100 L 4b				
19	M8 (5m)	4	35	39,796	1038	IRCM 83 / 112 M 4b				
22	M8 (5m)	4	42	33,003	861	IRCM 83 / 112 M 4b				
27	M8 (5m)	5,5	51	27,535	988	IRCM 83 / 132 S 4c				
Ø180	4,9	M8 (5m)	1,1	8,6	162,826	1168	IRCM 93 / 90 S 4a			
	5,4	M8 (5m)	1,1	9,5	146,946	1054	IRCM 93 / 90 S 4a			
	5,7	M8 (5m)	1,1	10	133,419	957	IRCM 93 / 90 S 4a			
	7,3	M8 (5m)	1,5	13	111,602	1092	IRCM 93 / 90 L 4a			
	9,0	M8 (5m)	2,2	16	87,936	1262	IRCM 93 / 100 L 4a			
	10	M8 (5m)	2,2	18	79,841	1145	IRCM 93 / 100 L 4a			
	12	M8 (5m)	2,2	21	66,785	958	IRCM 93 / 100 L 4a			
	13	M8 (5m)	3	23	61,444	1202	IRCM 93 / 100 L 4b			
	15	M8 (5m)	3	26	54,545	1067	IRCM 93 / 100 L 4b			
	18	M8 (5m)	4	31	44,753	1167	IRCM 93 / 112 M 4b			
	21	M8 (5m)	4	38	37,199	970	IRCM 93 / 112 M 4b			
	23	M8 (5m)	4	41	34,034	888	IRCM 93 / 112 M 4b			
	25	M8 (5m)	5,5	45	31,194	1119	IRCM 93 / 132 S 4c			
	5,7	M8 (5m)	1,1	10	133,509	958	IRCM 83 / 90 S 4a			
	6,8	M8 (5m)	1,5	12	121,711	1191	IRCM 83 / 90 L 4a			
	7,9	M8 (5m)	1,5	14	102,407	1002	IRCM 83 / 90 L 4a			
	8,5	M8 (5m)	1,5	15	92,330	903	IRCM 83 / 90 L 4a			
	11	M8 (5m)	2,2	19	75,613	1085	IRCM 83 / 100 L 4a			
	13	M8 (5m)	3	23	60,299	1180	IRCM 83 / 100 L 4b			
	15	M8 (5m)	3	26	54,358	1063	IRCM 83 / 100 L 4b			
16	M8 (5m)	3	29	48,314	945	IRCM 83 / 100 L 4b				
20	M8 (5m)	4	35	39,796	1038	IRCM 83 / 112 M 4b				
24	M8 (5m)	5,5	42	33,003	1184	IRCM 83 / 132 S 4c				
29	M8 (5m)	5,5	51	27,535	988	IRCM 83 / 132 S 4c				





D _T Tambur Çapı Drum Diameter <i>Diamètre de l'arbre</i> [mm]	V _h Kaldırma Hızı Lifting Speeds <i>Vitesse de levage</i> [m/min]	Vinç Sınıfı Crane Class <i>Classification de l'application de levage</i> ISO (FEM)	P ₁ Motor Gücü Power <i>Puissance</i> [kW]	n ₂ Çıkış Devri Output Speeds <i>Vitesse de sortie</i> [r.p.m]	i Tahvil Ratio <i>Rapport de réduction</i>	M ₂ Çıkış Momenti Output Torque <i>Couple de sortie</i>	Tip Type <i>Typ</i>			kg
Ø190	5,1	M8 (5m)	1,1	8,6	162,826	1168	IRCM 93 / 90 S 4a			
	5,7	M8 (5m)	1,1	9,5	146,946	1054	IRCM 93 / 90 S 4a			
	6,0	M8 (5m)	1,1	10	133,419	957	IRCM 93 / 90 S 4a			
	7,8	M8 (5m)	1,5	13	111,602	1092	IRCM 93 / 90 L 4a			
	9,5	M8 (5m)	2,2	16	87,936	1262	IRCM 93 / 100 L 4a			
	11	M8 (5m)	2,2	18	79,841	1145	IRCM 93 / 100 L 4a			
	13	M8 (5m)	2,2	21	66,785	958	IRCM 93 / 100 L 4a			
	14	M8 (5m)	3	23	61,444	1202	IRCM 93 / 100 L 4b			
	16	M8 (5m)	3	26	54,545	1067	IRCM 93 / 100 L 4b			
	18	M8 (5m)	4	31	44,753	1167	IRCM 93 / 112 M 4b			
	23	M8 (5m)	4	38	37,199	970	IRCM 93 / 112 M 4b			
	24	M8 (5m)	5,5	41	34,034	1221	IRCM 93 / 132 S 4c			
	27	M8 (5m)	5,5	45	31,194	1119	IRCM 93 / 132 S 4c			
	6,0	M8 (5m)	1,1	10	133,509	958	IRCM 83 / 90 S 4a			
	7,2	M8 (5m)	1,5	12	121,711	1191	IRCM 83 / 90 L 4a			
	8,4	M8 (5m)	1,5	14	102,407	1002	IRCM 83 / 90 L 4a			
	8,9	M8 (5m)	2,2	15	92,330	1325	IRCM 83 / 100 L 4a			
	11	M8 (5m)	2,2	19	75,613	1085	IRCM 83 / 100 L 4a			
	14	M8 (5m)	3	23	60,299	1180	IRCM 83 / 100 L 4b			
	16	M8 (5m)	3	26	54,358	1063	IRCM 83 / 100 L 4b			
17	M8 (5m)	3	29	48,314	945	IRCM 83 / 100 L 4b				
21	M8 (5m)	4	35	39,796	1038	IRCM 83 / 112 M 4b				
25	M7 (4m)	5,5	42	33,003	1184	IRCM 83 / 132 S 4c				
30	M7 (4m)	5,5	51	27,535	988	IRCM 83 / 132 S 4c				
Ø200	5,4	M8 (5m)	1,1	8,6	162,826	1168	IRCM 93 / 90 S 4a			
	6,0	M8 (5m)	1,1	9,5	146,946	1054	IRCM 93 / 90 S 4a			
	6,3	M8 (5m)	1,1	10	133,419	957	IRCM 93 / 90 S 4a			
	8,2	M8 (5m)	1,5	13	111,602	1092	IRCM 93 / 90 L 4a			
	10	M8 (5m)	2,2	16	87,936	1262	IRCM 93 / 100 L 4a			
	11	M8 (5m)	2,2	18	79,841	1145	IRCM 93 / 100 L 4a			
	13	M8 (5m)	3	21	66,785	1307	IRCM 93 / 100 L 4b			
	14	M8 (5m)	3	23	61,444	1202	IRCM 93 / 100 L 4b			
	16	M8 (5m)	3	26	54,545	1067	IRCM 93 / 100 L 4b			
	19	M8 (5m)	4	31	44,753	1167	IRCM 93 / 112 M 4b			
	24	M8 (5m)	5,5	38	37,199	1334	IRCM 93 / 132 S 4c			
	26	M8 (5m)	5,5	41	34,034	1221	IRCM 93 / 132 S 4c			
	28	M8 (5m)	5,5	45	31,194	1119	IRCM 93 / 132 S 4c			
	6,3	M8 (5m)	1,1	10	133,509	958	IRCM 83 / 90 S 4a			
	7,5	M8 (5m)	1,5	12	121,711	1191	IRCM 83 / 90 L 4a			
	8,8	M8 (5m)	2,2	14	102,407	1469	IRCM 83 / 100 L 4a			
	9,4	M8 (5m)	2,2	15	92,330	1325	IRCM 83 / 100 L 4a			
	12	M8 (5m)	2,2	19	75,613	1085	IRCM 83 / 100 L 4a			
	14	M8 (5m)	3	23	60,299	1180	IRCM 83 / 100 L 4b			
	16	M8 (5m)	3	26	54,358	1063	IRCM 83 / 100 L 4b			
18	M8 (5m)	4	29	48,314	1260	IRCM 83 / 112 M 4b				
22	M7 (4m)	4	35	39,796	1038	IRCM 83 / 112 M 4b				
26	M7 (4m)	5,5	42	33,003	1184	IRCM 83 / 132 S 4c				
32	M7 (4m)	7,5	51	27,535	1347	IRCM 83 / 132 M 4b				



Vinç sistemleri kaldırma redüktörleri güç ve devir tabloları / Power and ratio table for hoisting applications / Tableau de classification des couples et rapports de réduction pour les applications de levage



D _T Tambur Çapı Drum Diameter <i>Diamètre de l'arbre</i> [mm]	V _h Kaldırma Hızı Lifting Speeds <i>Vitesse de levage</i> [m/min]	Vinç Sınıfı Crane Class <i>Classification de l'application de levage</i> ISO (FEM)	P ₁ Motor Gücü Power <i>Puissance</i> [kW]	n ₂ Çıkış Devri Output Speeds <i>Vitesse de sortie</i> [r.p.m]	i Tahvil Ratio <i>Rapport de réduction</i>	M ₂ Çıkış Momenti Output Torque <i>Couple de sortie</i>	Tip Type <i>Typ</i>		 kg
Ø210	5,7	M8 (5m)	1,1	8,6	162,826	1168	IRCM 93 / 90 S 4a		
	6,3	M8 (5m)	1,1	9,5	146,946	1054	IRCM 93 / 90 S 4a		
	6,6	M8 (5m)	1,5	10	133,419	1305	IRCM 93 / 90 L 4a		
	8,6	M8 (5m)	1,5	13	111,602	1092	IRCM 93 / 90 L 4a		
	11	M8 (5m)	2,2	16	87,936	1262	IRCM 93 / 100 L 4a		
	12	M8 (5m)	2,2	18	79,841	1145	IRCM 93 / 100 L 4a		
	14	M8 (5m)	3	21	66,785	1307	IRCM 93 / 100 L 4b		
	15	M8 (5m)	3	23	61,444	1202	IRCM 93 / 100 L 4b		
	17	M8 (5m)	3	26	54,545	1067	IRCM 93 / 100 L 4b		
	20	M8 (5m)	4	31	44,753	1167	IRCM 93 / 112 M 4b		
	25	M8 (5m)	5,5	38	37,199	1334	IRCM 93 / 132 S 4c		
	27	M8 (5m)	5,5	41	34,034	1221	IRCM 93 / 132 S 4c		
	30	M8 (5m)	5,5	45	31,194	1119	IRCM 93 / 132 S 4c		
	6,6	M8 (5m)	1,5	10	133,509	1306	IRCM 83 / 90 L 4a		
	7,9	M8 (5m)	1,5	12	121,711	1191	IRCM 83 / 90 L 4a		
	9,2	M8 (5m)	2,2	14	102,407	1469	IRCM 83 / 100 L 4a		
	9,9	M8 (5m)	2,2	15	92,330	1325	IRCM 83 / 100 L 4a		
	13	M7 (4m)	2,2	19	75,613	1085	IRCM 83 / 100 L 4a		
	15	M7 (4m)	3	23	60,299	1180	IRCM 83 / 100 L 4b		
	17	M7 (4m)	3	26	54,358	1063	IRCM 83 / 100 L 4b		
19	M7 (4m)	4	29	48,314	1260	IRCM 83 / 112 M 4b			
23	M7 (4m)	4	35	39,796	1038	IRCM 83 / 112 M 4b			
28	M7 (4m)	5,5	42	33,003	1184	IRCM 83 / 132 S 4c			
34	M7 (4m)	7,5	51	27,535	1347	IRCM 83 / 132 M 4b			
Ø220	5,9	M8 (5m)	1,1	8,6	162,826	1168	IRCM 93 / 90 S 4a		
	6,6	M8 (5m)	1,5	9,5	146,946	1437	IRCM 93 / 90 L 4a		
	6,9	M8 (5m)	1,5	10	133,419	1305	IRCM 93 / 90 L 4a		
	9,0	M8 (5m)	2,2	13	111,602	1601	IRCM 93 / 100 L 4a		
	11	M8 (5m)	2,2	16	87,936	1262	IRCM 93 / 100 L 4a		
	12	M8 (5m)	2,2	18	79,841	1145	IRCM 93 / 100 L 4a		
	15	M8 (5m)	3	21	66,785	1307	IRCM 93 / 100 L 4b		
	16	M8 (5m)	3	23	61,444	1202	IRCM 93 / 100 L 4b		
	18	M8 (5m)	4	26	54,545	1423	IRCM 93 / 112 M 4b		
	21	M8 (5m)	4	31	44,753	1167	IRCM 93 / 112 M 4b		
	26	M8 (5m)	5,5	38	37,199	1334	IRCM 93 / 132 S 4c		
	28	M8 (5m)	5,5	41	34,034	1221	IRCM 93 / 132 S 4c		
	31	M8 (5m)	5,5	45	31,194	1119	IRCM 93 / 132 S 4c		
	6,9	M7 (4m)	1,5	10	133,509	1306	IRCM 83 / 90 L 4a		
	8,3	M7 (4m)	1,5	12	121,711	1191	IRCM 83 / 90 L 4a		
	9,7	M7 (4m)	2,2	14	102,407	1469	IRCM 83 / 100 L 4a		
	10	M7 (4m)	2,2	15	92,330	1325	IRCM 83 / 100 L 4a		
	13	M7 (4m)	3	19	75,613	1479	IRCM 83 / 100 L 4b		
	16	M7 (4m)	3	23	60,299	1180	IRCM 83 / 100 L 4b		
	18	M7 (4m)	4	26	54,358	1418	IRCM 83 / 112 M 4b		
20	M7 (4m)	4	29	48,314	1260	IRCM 83 / 112 M 4b			
24	M7 (4m)	5,5	35	39,796	1427	IRCM 83 / 132 S 4c			
29	M7 (4m)	5,5	42	33,003	1184	IRCM 83 / 132 S 4c			
35	M7 (4m)	7,5	51	27,535	1347	IRCM 83 / 132 M 4b			





D _T Tambur Çapı Drum Diameter <i>Diamètre de l'arbre</i> [mm]	V _h Kaldırma Hızı Lifting Speeds <i>Vitesse de levage</i> [m/min]	Vinç Sınıfı Crane Class <i>Classification de l'application de levage</i> ISO (FEM)	P ₁ Motor Gücü Power <i>Puissance</i> [kW]	n ₂ Çıkış Devri Output Speeds <i>Vitesse de sortie</i> [r.p.m]	i Tahvil Ratio <i>Rapport de réduction</i>	M ₂ Çıkış Momenti Output Torque <i>Couple de sortie</i>	Tip Type <i>Typ</i>		 kg
Ø230	6,2	M8 (5m)	1,1	8,6	162,826	1168	IRCM 93 / 90 S 4a		
	6,9	M8 (5m)	1,5	9,5	146,946	1437	IRCM 93 / 90 L 4a		
	7,2	M8 (5m)	1,5	10	133,419	1305	IRCM 93 / 90 L 4a		
	9,4	M8 (5m)	2,2	13	111,602	1601	IRCM 93 / 100 L 4a		
	12	M8 (5m)	2,2	16	87,936	1262	IRCM 93 / 100 L 4a		
	13	M8 (5m)	3	18	79,841	1562	IRCM 93 / 100 L 4b		
	15	M8 (5m)	3	21	66,785	1307	IRCM 93 / 100 L 4b		
	17	M8 (5m)	3	23	61,444	1202	IRCM 93 / 100 L 4b		
	19	M8 (5m)	4	26	54,545	1423	IRCM 93 / 112 M 4b		
	22	M8 (5m)	4	31	44,753	1167	IRCM 93 / 112 M 4b		
	27	M8 (5m)	5,5	38	37,199	1334	IRCM 93 / 132 S 4c		
	30	M8 (5m)	5,5	41	34,034	1221	IRCM 93 / 132 S 4c		
	32	M8 (5m)	7,5	45	31,194	1526	IRCM 93 / 132 M 4b		
	7,2	M7 (4m)	1,5	10	133,509	1306	IRCM 83 / 90 L 4a		
	8,7	M7 (4m)	1,5	12	121,711	1191	IRCM 83 / 90 L 4a		
	10	M7 (4m)	2,2	14	102,407	1469	IRCM 83 / 100 L 4a		
	11	M7 (4m)	2,2	15	92,330	1325	IRCM 83 / 100 L 4a		
	14	M7 (4m)	3	19	75,613	1479	IRCM 83 / 100 L 4b		
	17	M7 (4m)	3	23	60,299	1180	IRCM 83 / 100 L 4b		
	19	M7 (4m)	4	26	54,358	1418	IRCM 83 / 112 M 4b		
21	M7 (4m)	4	29	48,314	1260	IRCM 83 / 112 M 4b			
25	M7 (4m)	5,5	35	39,796	1427	IRCM 83 / 132 S 4c			
30	M7 (4m)	5,5	42	33,003	1184	IRCM 83 / 132 S 4c			
37	M7 (4m)	7,5	51	27,535	1347	IRCM 83 / 132 M 4b			
Ø240	6,5	M8 (5m)	1,5	8,6	162,826	1593	IRCM 93 / 90 L 4a		
	7,2	M8 (5m)	1,5	9,5	146,946	1437	IRCM 93 / 90 L 4a		
	7,5	M8 (5m)	1,5	10	133,419	1305	IRCM 93 / 90 L 4a		
	9,8	M8 (5m)	2,2	13	111,602	1601	IRCM 93 / 100 L 4a		
	12	M8 (5m)	2,2	16	87,936	1262	IRCM 93 / 100 L 4a		
	14	M8 (5m)	3	18	79,841	1562	IRCM 93 / 100 L 4b		
	16	M8 (5m)	3	21	66,785	1307	IRCM 93 / 100 L 4b		
	17	M8 (5m)	3	23	61,444	1202	IRCM 93 / 100 L 4b		
	20	M8 (5m)	4	26	54,545	1423	IRCM 93 / 112 M 4b		
	23	M8 (5m)	5,5	31	44,753	1605	IRCM 93 / 132 S 4c		
	29	M8 (5m)	5,5	38	37,199	1334	IRCM 93 / 132 S 4c		
	31	M8 (5m)	5,5	41	34,034	1221	IRCM 93 / 132 S 4c		
	34	M8 (5m)	7,5	45	31,194	1526	IRCM 93 / 132 M 4b		
	7,5	M7 (4m)	1,5	10	133,509	1306	IRCM 83 / 90 L 4a		
	9,0	M7 (4m)	2,2	12	121,711	1746	IRCM 83 / 100 L 4a		
	11	M7 (4m)	2,2	14	102,407	1469	IRCM 83 / 100 L 4a		
	11	M7 (4m)	2,2	15	92,330	1325	IRCM 83 / 100 L 4a		
	14	M7 (4m)	3	19	75,613	1479	IRCM 83 / 100 L 4b		
	17	M7 (4m)	3	23	60,299	1180	IRCM 83 / 100 L 4b		
	20	M7 (4m)	4	26	54,358	1418	IRCM 83 / 112 M 4b		
22	M7 (4m)	4	29	48,314	1260	IRCM 83 / 112 M 4b			
26	M7 (4m)	5,5	35	39,796	1427	IRCM 83 / 132 S 4c			
32	M6 (3m)	5,5	42	33,003	1184	IRCM 83 / 132 S 4c			
38	M6 (3m)	7,5	51	27,535	1347	IRCM 83 / 132 M 4b			



Vinç sistemleri kaldırma redüktörleri güç ve devir tabloları / Power and ratio table for hoisting applications / Tableau de classification des couples et rapports de réduction pour les applications de levage



D _T Tambur Çapı Drum Diameter Diamètre de l'arbre [mm]	V _h Kaldırma Hızı Lifting Speeds Vitesse de levage [m/min]	Vinç Sınıfı Crane Class Classification de l'application de levage ISO (FEM)	P ₁ Motor Gücü Power Puissance [kW]	n ₂ Çıkış Devri Output Speeds Vitesse de sortie [r.p.m]	i Tahvil Ratio Rapport de réduction	M ₂ Çıkış Momenti Output Torque Couple de sortie	Tip Type Typ		 kg
Ø110	2,1	M8 (5m)	0,37	12	120,792	291	IRCM 73 / 71 M 4b		
	2,2	M8 (5m)	0,55	13	107,423	385	IRCM 73 / 80 M 4a		
	2,6	M8 (5m)	0,55	15	96,194	345	IRCM 73 / 80 M 4a		
	2,8	M8 (5m)	0,55	16	86,628	311	IRCM 73 / 80 M 4a		
	3,3	M8 (5m)	0,75	19	73,889	361	IRCM 73 / 80 M 4b		
	3,6	M8 (5m)	0,75	21	65,252	319	IRCM 73 / 80 M 4b		
	4,1	M8 (5m)	0,75	24	57,996	284	IRCM 73 / 80 M 4b		
	4,7	M8 (5m)	1,1	27	51,846	372	IRCM 73 / 90 S 4a		
	5,7	M8 (5m)	1,1	33	41,848	300	IRCM 73 / 90 S 4a		
	6,7	M8 (5m)	1,5	39	35,564	348	IRCM 73 / 90 L 4a		
	7,6	M8 (5m)	1,5	44	32,098	314	IRCM 73 / 90 L 4a		
	9,2	M8 (5m)	2,2	53	26,291	377	IRCM 73 / 100 L 4a		
10	M8 (5m)	2,2	59	23,834	342	IRCM 73 / 100 L 4a			
Ø120	2,3	M8 (5m)	0,55	12	120,792	433	IRCM 73 / 80 M 4a		
	2,4	M8 (5m)	0,55	13	107,423	385	IRCM 73 / 80 M 4a		
	2,8	M8 (5m)	0,55	15	96,194	345	IRCM 73 / 80 M 4a		
	3,0	M8 (5m)	0,55	16	86,628	311	IRCM 73 / 80 M 4a		
	3,6	M8 (5m)	0,75	19	73,889	361	IRCM 73 / 80 M 4b		
	4,0	M8 (5m)	0,75	21	65,252	319	IRCM 73 / 80 M 4b		
	4,5	M8 (5m)	1,1	24	57,996	416	IRCM 73 / 90 S 4a		
	5,1	M8 (5m)	1,1	27	51,846	372	IRCM 73 / 90 S 4a		
	6,2	M8 (5m)	1,1	33	41,848	300	IRCM 73 / 90 S 4a		
	7,3	M8 (5m)	1,5	39	35,564	348	IRCM 73 / 90 L 4a		
	8,3	M8 (5m)	1,5	44	32,098	314	IRCM 73 / 90 L 4a		
	10	M8 (5m)	2,2	53	26,291	377	IRCM 73 / 100 L 4a		
11	M8 (5m)	2,2	59	23,834	342	IRCM 73 / 100 L 4a			
Ø130	2,4	M8 (5m)	0,55	12	120,792	433	IRCM 73 / 80 M 4a		
	2,7	M8 (5m)	0,55	13	107,423	385	IRCM 73 / 80 M 4a		
	3,1	M8 (5m)	0,55	15	96,194	345	IRCM 73 / 80 M 4a		
	3,3	M8 (5m)	0,75	16	86,628	424	IRCM 73 / 80 M 4b		
	3,9	M8 (5m)	0,75	19	73,889	361	IRCM 73 / 80 M 4b		
	4,3	M8 (5m)	0,75	21	65,252	319	IRCM 73 / 80 M 4b		
	4,9	M8 (5m)	1,1	24	57,996	416	IRCM 73 / 90 S 4a		
	5,5	M8 (5m)	1,1	27	51,846	372	IRCM 73 / 90 S 4a		
	6,7	M8 (5m)	1,5	33	41,848	409	IRCM 73 / 90 L 4a		
	8,0	M8 (5m)	1,5	39	35,564	348	IRCM 73 / 90 L 4a		
	9,0	M8 (5m)	2,2	44	32,098	461	IRCM 73 / 100 L 4a		
	11	M8 (5m)	2,2	53	26,291	377	IRCM 73 / 100 L 4a		
12	M8 (5m)	2,2	59	23,834	342	IRCM 73 / 100 L 4a			
Ø140	2,6	M8 (5m)	0,55	12	120,792	433	IRCM 73 / 80 M 4a		
	2,9	M8 (5m)	0,55	13	107,423	385	IRCM 73 / 80 M 4a		
	3,3	M8 (5m)	0,75	15	96,194	470	IRCM 73 / 80 M 4b		
	3,5	M8 (5m)	0,75	16	86,628	424	IRCM 73 / 80 M 4b		
	4,2	M8 (5m)	0,75	19	73,889	361	IRCM 73 / 80 M 4b		
	4,6	M8 (5m)	1,1	21	65,252	468	IRCM 73 / 90 S 4a		
	5,3	M8 (5m)	1,1	24	57,996	416	IRCM 73 / 90 S 4a		
	5,9	M8 (5m)	1,1	27	51,846	372	IRCM 73 / 90 S 4a		
	7,3	M8 (5m)	1,5	33	41,848	409	IRCM 73 / 90 L 4a		
	8,6	M8 (5m)	1,5	39	35,564	348	IRCM 73 / 90 L 4a		
	9,7	M8 (5m)	2,2	44	32,098	461	IRCM 73 / 100 L 4a		
	12	M8 (5m)	2,2	53	26,291	377	IRCM 73 / 100 L 4a		
	13	M8 (5m)	3	59	23,834	466	IRCM 73 / 100 L 4b		





D _T Tambur Çapı Drum Diameter <i>Diamètre de l'arbre</i> [mm]	V _h Kaldırma Hızı Lifting Speeds <i>Vitesse de levage</i> [m/min]	Vinç Sınıfı Crane Class <i>Classification de l'application de levage</i> ISO (FEM)	P ₁ Motor Gücü Power <i>Puissance</i> [kW]	n ₂ Çıkış Devri Output Speeds <i>Vitesse de sortie</i> [r.p.m]	i Tahvil Ratio <i>Rapport de réduction</i>	M ₂ Çıkış Momenti Output Torque <i>Couple de sortie</i>	Tip Type <i>Typ</i>		 kg
Ø150	2,8	M8 (5m)	0,55	12	120,792	433	IRCM 73 / 80 M 4a		
	3,1	M8 (5m)	0,55	13	107,423	385	IRCM 73 / 80 M 4a		
	3,5	M8 (5m)	0,75	15	96,194	470	IRCM 73 / 80 M 4b		
	3,8	M8 (5m)	0,75	16	86,628	424	IRCM 73 / 80 M 4b		
	4,5	M8 (5m)	1,1	19	73,889	530	IRCM 73 / 90 S 4a		
	4,9	M8 (5m)	1,1	21	65,252	468	IRCM 73 / 90 S 4a		
	5,7	M8 (5m)	1,1	24	57,996	416	IRCM 73 / 90 S 4a		
	6,4	M8 (5m)	1,1	27	51,846	372	IRCM 73 / 90 S 4a		
	7,8	M8 (5m)	1,5	33	41,848	409	IRCM 73 / 90 L 4a		
	9,2	M8 (5m)	2,2	39	35,564	510	IRCM 73 / 100 L 4a		
	10	M8 (5m)	2,2	44	32,098	461	IRCM 73 / 100 L 4a		
	12	M8 (5m)	2,2	53	26,291	377	IRCM 73 / 100 L 4a		
	14	M8 (5m)	3	59	23,834	466	IRCM 73 / 100 L 4b		
Ø160	3,0	M8 (5m)	0,55	12	120,792	433	IRCM 73 / 80 M 4a		
	3,3	M8 (5m)	0,75	13	107,423	525	IRCM 73 / 80 M 4b		
	3,8	M8 (5m)	0,75	15	96,194	470	IRCM 73 / 80 M 4b		
	4,0	M8 (5m)	0,75	16	86,628	424	IRCM 73 / 80 M 4b		
	4,8	M8 (5m)	1,1	19	73,889	530	IRCM 73 / 90 S 4a		
	5,3	M8 (5m)	1,1	21	65,252	468	IRCM 73 / 90 S 4a		
	6,0	M8 (5m)	1,1	24	57,996	416	IRCM 73 / 90 S 4a		
	6,8	M8 (5m)	1,5	27	51,846	507	IRCM 73 / 90 L 4a		
	8,3	M8 (5m)	1,5	33	41,848	409	IRCM 73 / 90 L 4a		
	9,8	M8 (5m)	2,2	39	35,564	510	IRCM 73 / 100 L 4a		
	11	M8 (5m)	2,2	44	32,098	461	IRCM 73 / 100 L 4a		
	13	M8 (5m)	3	53	26,291	514	IRCM 73 / 100 L 4b		
	15	M8 (5m)	3	59	23,834	466	IRCM 73 / 100 L 4b		
Ø170	3,2	M8 (5m)	0,75	12	120,792	591	IRCM 73 / 80 M 4b		
	3,5	M8 (5m)	0,75	13	107,423	525	IRCM 73 / 80 M 4b		
	4,0	M8 (5m)	0,75	15	96,194	470	IRCM 73 / 80 M 4b		
	4,3	M8 (5m)	0,75	16	86,628	424	IRCM 73 / 80 M 4b		
	5,1	M8 (5m)	1,1	19	73,889	530	IRCM 73 / 90 S 4a		
	5,6	M8 (5m)	1,1	21	65,252	468	IRCM 73 / 90 S 4a		
	6,4	M8 (5m)	1,5	24	57,996	567	IRCM 73 / 90 L 4a		
	7,2	M8 (5m)	1,5	27	51,846	507	IRCM 73 / 90 L 4a		
	8,8	M8 (5m)	2,2	33	41,848	600	IRCM 73 / 100 L 4a		
	10	M8 (5m)	2,2	39	35,564	510	IRCM 73 / 100 L 4a		
	12	M8 (5m)	2,2	44	32,098	461	IRCM 73 / 100 L 4a		
	14	M8 (5m)	3	53	26,291	514	IRCM 73 / 100 L 4b		
	16	M8 (5m)	3	59	23,834	466	IRCM 73 / 100 L 4b		
Ø180	3,4	M8 (5m)	0,75	12	120,792	591	IRCM 73 / 80 M 4b		
	3,7	M8 (5m)	0,75	13	107,423	525	IRCM 73 / 80 M 4b		
	4,2	M8 (5m)	0,75	15	96,194	470	IRCM 73 / 80 M 4b		
	4,5	M8 (5m)	1,1	16	86,628	621	IRCM 73 / 90 S 4a		
	5,4	M8 (5m)	1,1	19	73,889	530	IRCM 73 / 90 S 4a		
	5,9	M8 (5m)	1,1	21	65,252	468	IRCM 73 / 90 S 4a		
	6,8	M8 (5m)	1,5	24	57,996	567	IRCM 73 / 90 L 4a		
	7,6	M8 (5m)	1,5	27	51,846	507	IRCM 73 / 90 L 4a		
	9,3	M8 (5m)	2,2	33	41,848	600	IRCM 73 / 100 L 4a		
	11	M8 (5m)	2,2	39	35,564	510	IRCM 73 / 100 L 4a		
	12	M8 (5m)	2,2	44	32,098	461	IRCM 73 / 100 L 4a		
	15	M8 (5m)	3	53	26,291	514	IRCM 73 / 100 L 4b		
	17	M8 (5m)	3	59	23,834	466	IRCM 73 / 100 L 4b		



Vinç sistemleri kaldırma redüktörleri güç ve devir tabloları / Power and ratio table for hoisting applications / Tableau de classification des couples et rapports de réduction pour les applications de levage

D _T Tambur Çapı Drum Diameter Diamètre de l'arbre [mm]	V _h Kaldırma Hızı Lifting Speeds Vitesse de levage [m/min]	Vinç Sınıfı Crane Class Classification de l'application de levage ISO (FEM)	P ₁ Motor Gücü Power Puissance [kW]	n ₂ Çıkış Devri Output Speeds Vitesse de sortie [r.p.m]	i Tahvil Ratio Rapport de réduction	M ₂ Çıkış Momenti Output Torque Couple de sortie	Tip Type Typ		 kg
Ø170	4,6	M8 (5m)	1,1	8,6	162,826	1168	IRCM 93 / 90 S 4a		
	5,1	M8 (5m)	1,1	9,5	146,946	1054	IRCM 93 / 90 S 4a		
	5,3	M8 (5m)	1,5	10	133,419	1305	IRCM 93 / 90 L 4a		
	6,9	M8 (5m)	1,5	13	111,602	1092	IRCM 93 / 90 L 4a		
	8,5	M8 (5m)	2,2	16	87,936	1262	IRCM 93 / 100 L 4a		
	9,6	M8 (5m)	2,2	18	79,841	1145	IRCM 93 / 100 L 4a		
	11	M8 (5m)	3	21	66,785	1307	IRCM 93 / 100 L 4b		
	12	M8 (5m)	3	23	61,444	1202	IRCM 93 / 100 L 4b		
	14	M8 (5m)	3	26	54,545	1067	IRCM 93 / 100 L 4b		
	17	M8 (5m)	4	31	44,753	1167	IRCM 93 / 112 M 4b		
	20	M8 (5m)	5,5	38	37,199	1334	IRCM 93 / 132 S 4c		
	22	M8 (5m)	5,5	41	34,034	1221	IRCM 93 / 132 S 4c		
	24	M8 (5m)	5,5	45	31,194	1119	IRCM 93 / 132 S 4c		
	5,3	M8 (5m)	1,5	10	133,509	1306	IRCM 83 / 90 L 4a		
	6,4	M8 (5m)	1,5	12	121,711	1191	IRCM 83 / 90 L 4a		
	7,5	M8 (5m)	2,2	14	102,407	1469	IRCM 83 / 100 L 4a		
	8,0	M8 (5m)	2,2	15	92,330	1325	IRCM 83 / 100 L 4a		
	10	M7 (4m)	2,2	19	75,613	1085	IRCM 83 / 100 L 4a		
	12	M7 (4m)	3	23	60,299	1180	IRCM 83 / 100 L 4b		
	14	M7 (4m)	3	26	54,358	1063	IRCM 83 / 100 L 4b		
15	M7 (4m)	4	29	48,314	1260	IRCM 83 / 112 M 4b			
19	M7 (4m)	5,5	35	39,796	1427	IRCM 83 / 132 S 4c			
22	M7 (4m)	5,5	42	33,003	1184	IRCM 83 / 132 S 4c			
27	M7 (4m)	7,5	51	27,535	1347	IRCM 83 / 132 M 4b			
Ø180	4,9	M8 (5m)	1,1	8,6	162,826	1168	IRCM 93 / 90 S 4a		
	5,4	M8 (5m)	1,5	9,5	146,946	1437	IRCM 93 / 90 L 4a		
	5,7	M8 (5m)	1,5	10	133,419	1305	IRCM 93 / 90 L 4a		
	7,3	M8 (5m)	2,2	13	111,602	1601	IRCM 93 / 100 L 4a		
	9,0	M8 (5m)	2,2	16	87,936	1262	IRCM 93 / 100 L 4a		
	10	M8 (5m)	2,2	18	79,841	1145	IRCM 93 / 100 L 4a		
	12	M8 (5m)	3	21	66,785	1307	IRCM 93 / 100 L 4b		
	13	M8 (5m)	3	23	61,444	1202	IRCM 93 / 100 L 4b		
	15	M8 (5m)	4	26	54,545	1423	IRCM 93 / 112 M 4b		
	18	M8 (5m)	4	31	44,753	1167	IRCM 93 / 112 M 4b		
	21	M8 (5m)	5,5	38	37,199	1334	IRCM 93 / 132 S 4c		
	23	M8 (5m)	5,5	41	34,034	1221	IRCM 93 / 132 S 4c		
	25	M8 (5m)	5,5	45	31,194	1119	IRCM 93 / 132 S 4c		
	5,7	M7 (4m)	1,5	10	133,509	1306	IRCM 83 / 90 L 4a		
	6,8	M7 (4m)	1,5	12	121,711	1191	IRCM 83 / 90 L 4a		
	7,9	M7 (4m)	2,2	14	102,407	1469	IRCM 83 / 100 L 4a		
	8,5	M7 (4m)	2,2	15	92,330	1325	IRCM 83 / 100 L 4a		
	11	M7 (4m)	3	19	75,613	1479	IRCM 83 / 100 L 4b		
	13	M7 (4m)	3	23	60,299	1180	IRCM 83 / 100 L 4b		
	15	M7 (4m)	4	26	54,358	1418	IRCM 83 / 112 M 4b		
16	M7 (4m)	4	29	48,314	1260	IRCM 83 / 112 M 4b			
20	M7 (4m)	5,5	35	39,796	1427	IRCM 83 / 132 S 4c			
24	M7 (4m)	5,5	42	33,003	1184	IRCM 83 / 132 S 4c			
29	M7 (4m)	7,5	51	27,535	1347	IRCM 83 / 132 M 4b			





D _T Tambur Çapı Drum Diameter <i>Diamètre de l'arbre</i> [mm]	V _h Kaldırma Hızı Lifting Speeds <i>Vitesse de levage</i> [m/min]	Vinç Sınıfı Crane Class <i>Classification de l'application de levage</i> ISO (FEM)	P ₁ Motor Gücü Power <i>Puissance</i> [kW]	n ₂ Çıkış Devri Output Speeds <i>Vitesse de sortie</i> [r.p.m]	i Tahvil Ratio <i>Rapport de réduction</i>	M ₂ Çıkış Momenti Output Torque <i>Couple de sortie</i>	Tip Type <i>Typ</i>		 kg
Ø190	5,1	M8 (5m)	1,5	8,6	162,826	1593	IRCM 93 / 90 L 4a		
	5,7	M8 (5m)	1,5	9,5	146,946	1437	IRCM 93 / 90 L 4a		
	6,0	M8 (5m)	1,5	10	133,419	1305	IRCM 93 / 90 L 4a		
	7,8	M8 (5m)	2,2	13	111,602	1601	IRCM 93 / 100 L 4a		
	9,5	M8 (5m)	2,2	16	87,936	1262	IRCM 93 / 100 L 4a		
	11	M8 (5m)	3	18	79,841	1562	IRCM 93 / 100 L 4b		
	13	M8 (5m)	3	21	66,785	1307	IRCM 93 / 100 L 4b		
	14	M8 (5m)	3	23	61,444	1202	IRCM 93 / 100 L 4b		
	16	M8 (5m)	4	26	54,545	1423	IRCM 93 / 112 M 4b		
	18	M8 (5m)	4	31	44,753	1167	IRCM 93 / 112 M 4b		
	23	M8 (5m)	5,5	38	37,199	1334	IRCM 93 / 132 S 4c		
	24	M8 (5m)	5,5	41	34,034	1221	IRCM 93 / 132 S 4c		
	27	M8 (5m)	7,5	45	31,194	1526	IRCM 93 / 132 M 4b		
	6,0	M7 (4m)	1,5	10	133,509	1306	IRCM 83 / 90 L 4a		
	7,2	M7 (4m)	2,2	12	121,711	1746	IRCM 83 / 100 L 4a		
	8,4	M7 (4m)	2,2	14	102,407	1469	IRCM 83 / 100 L 4a		
	8,9	M7 (4m)	2,2	15	92,330	1325	IRCM 83 / 100 L 4a		
	11	M7 (4m)	3	19	75,613	1479	IRCM 83 / 100 L 4b		
	14	M7 (4m)	3	23	60,299	1180	IRCM 83 / 100 L 4b		
	16	M7 (4m)	4	26	54,358	1418	IRCM 83 / 112 M 4b		
17	M7 (4m)	4	29	48,314	1260	IRCM 83 / 112 M 4b			
21	M7 (4m)	5,5	35	39,796	1427	IRCM 83 / 132 S 4c			
25	M7 (4m)	5,5	42	33,003	1184	IRCM 83 / 132 S 4c			
30	M6 (3m)	7,5	51	27,535	1347	IRCM 83 / 132 M 4b			
Ø200	5,4	M8 (5m)	1,5	8,6	162,826	1593	IRCM 93 / 90 L 4a		
	6,0	M8 (5m)	1,5	9,5	146,946	1437	IRCM 93 / 90 L 4a		
	6,3	M8 (5m)	1,5	10	133,419	1305	IRCM 93 / 90 L 4a		
	8,2	M8 (5m)	2,2	13	111,602	1601	IRCM 93 / 100 L 4a		
	10	M8 (5m)	2,2	16	87,936	1262	IRCM 93 / 100 L 4a		
	11	M8 (5m)	3	18	79,841	1562	IRCM 93 / 100 L 4b		
	13	M8 (5m)	3	21	66,785	1307	IRCM 93 / 100 L 4b		
	14	M8 (5m)	4	23	61,444	1603	IRCM 93 / 112 M 4b		
	16	M8 (5m)	4	26	54,545	1423	IRCM 93 / 112 M 4b		
	19	M8 (5m)	5,5	31	44,753	1605	IRCM 93 / 132 S 4c		
	24	M8 (5m)	5,5	38	37,199	1334	IRCM 93 / 132 S 4c		
	26	M8 (5m)	7,5	41	34,034	1665	IRCM 93 / 132 M 4b		
	28	M8 (5m)	7,5	45	31,194	1526	IRCM 93 / 132 M 4b		
	6,3	M7 (4m)	1,5	10	133,509	1306	IRCM 83 / 90 L 4a		
	7,5	M7 (4m)	2,2	12	121,711	1746	IRCM 83 / 100 L 4a		
	8,8	M7 (4m)	2,2	14	102,407	1469	IRCM 83 / 100 L 4a		
	9,4	M7 (4m)	2,2	15	92,330	1325	IRCM 83 / 100 L 4a		
	12	M7 (4m)	3	19	75,613	1479	IRCM 83 / 100 L 4b		
	14	M7 (4m)	4	23	60,299	1573	IRCM 83 / 112 M 4b		
	16	M7 (4m)	4	26	54,358	1418	IRCM 83 / 112 M 4b		
18	M7 (4m)	4	29	48,314	1260	IRCM 83 / 112 M 4b			
22	M6 (3m)	5,5	35	39,796	1427	IRCM 83 / 132 S 4c			
26	M6 (3m)	7,5	42	33,003	1614	IRCM 83 / 132 M 4b			
32	M6 (3m)	7,5	51	27,535	1347	IRCM 83 / 132 M 4b			



Vinç sistemleri kaldırma redüktörleri güç ve devir tabloları / Power and ratio table for hoisting applications / Tableau de classification des couples et rapports de réduction pour les applications de levage



Vinç sistemleri kaldırma redüktörleri güç ve devir tabloları / Power and ratio table for hoisting applications / Tableau de classification des couples et rapports de réduction pour les applications de levage



D _T Tambur Çapı Drum Diameter Diamètre de l'arbre [mm]	V _h Kaldırma Hızı Lifting Speeds Vitesse de levage [m/min]	Vinç Sınıfı Crane Class Classification de l'application de levage ISO (FEM)	P ₁ Motor Gücü Power Puissance [kW]	n ₂ Çıkış Devri Output Speeds Vitesse de sortie [r.p.m]	i Tahvil Ratio Rapport de réduction	M ₂ Çıkış Momenti Output Torque Couple de sortie	Tip Type Typ		 kg
Ø210	5,7	M8 (5m)	1,5	8,6	162,826	1593	IRCM 93 / 90 L 4a		
	6,3	M8 (5m)	1,5	9,5	146,946	1437	IRCM 93 / 90 L 4a		
	6,6	M8 (5m)	1,5	10	133,419	1305	IRCM 93 / 90 L 4a		
	8,6	M8 (5m)	2,2	13	111,602	1601	IRCM 93 / 100 L 4a		
	11	M8 (5m)	3	16	87,936	1720	IRCM 93 / 100 L 4b		
	12	M8 (5m)	3	18	79,841	1562	IRCM 93 / 100 L 4b		
	14	M8 (5m)	3	21	66,785	1307	IRCM 93 / 100 L 4b		
	15	M8 (5m)	4	23	61,444	1603	IRCM 93 / 112 M 4b		
	17	M8 (5m)	4	26	54,545	1423	IRCM 93 / 112 M 4b		
	20	M8 (5m)	5,5	31	44,753	1605	IRCM 93 / 132 S 4c		
	25	M8 (5m)	5,5	38	37,199	1334	IRCM 93 / 132 S 4c		
	27	M8 (5m)	7,5	41	34,034	1665	IRCM 93 / 132 M 4b		
	30	M8 (5m)	7,5	45	31,194	1526	IRCM 93 / 132 M 4b		
	6,6	M7 (4m)	1,5	10	133,509	1306	IRCM 83 / 90 L 4a		
	7,9	M7 (4m)	2,2	12	121,711	1746	IRCM 83 / 100 L 4a		
	9,2	M7 (4m)	2,2	14	102,407	1469	IRCM 83 / 100 L 4a		
	9,9	M7 (4m)	2,2	15	92,330	1325	IRCM 83 / 100 L 4a		
	13	M7 (4m)	3	19	75,613	1479	IRCM 83 / 100 L 4b		
	15	M7 (4m)	4	23	60,299	1573	IRCM 83 / 112 M 4b		
	17	M7 (4m)	4	26	54,358	1418	IRCM 83 / 112 M 4b		
19	M6 (3m)	5,5	29	48,314	1733	IRCM 83 / 132 S 4c			
23	M6 (3m)	5,5	35	39,796	1427	IRCM 83 / 132 S 4c			
28	M6 (3m)	7,5	42	33,003	1614	IRCM 83 / 132 M 4b			
34	M6 (3m)	7,5	51	27,535	1347	IRCM 83 / 132 M 4b			
Ø220	5,9	M8 (5m)	1,5	8,6	162,826	1593	IRCM 93 / 90 L 4a		
	6,6	M8 (5m)	1,5	9,5	146,946	1437	IRCM 93 / 90 L 4a		
	6,9	M8 (5m)	1,5	10	133,419	1305	IRCM 93 / 90 L 4a		
	9,0	M8 (5m)	2,2	13	111,602	1601	IRCM 93 / 100 L 4a		
	11	M8 (5m)	3	16	87,936	1720	IRCM 93 / 100 L 4b		
	12	M8 (5m)	3	18	79,841	1562	IRCM 93 / 100 L 4b		
	15	M8 (5m)	4	21	66,785	1742	IRCM 93 / 112 M 4b		
	16	M8 (5m)	4	23	61,444	1603	IRCM 93 / 112 M 4b		
	18	M8 (5m)	4	26	54,545	1423	IRCM 93 / 112 M 4b		
	21	M8 (5m)	5,5	31	44,753	1605	IRCM 93 / 132 S 4c		
	26	M8 (5m)	7,5	38	37,199	1819	IRCM 93 / 132 M 4b		
	28	M8 (5m)	7,5	41	34,034	1665	IRCM 93 / 132 M 4b		
	31	M8 (5m)	7,5	45	31,194	1526	IRCM 93 / 132 M 4b		
	6,9	M7 (4m)	1,5	10	133,509	1306	IRCM 83 / 90 L 4a		
	8,3	M7 (4m)	2,2	12	121,711	1746	IRCM 83 / 100 L 4a		
	9,7	M6 (3m)	2,2	14	102,407	1469	IRCM 83 / 100 L 4a		
	10	M6 (3m)	3	15	92,330	1806	IRCM 83 / 100 L 4b		
	13	M6 (3m)	3	19	75,613	1479	IRCM 83 / 100 L 4b		
	16	M6 (3m)	4	23	60,299	1573	IRCM 83 / 112 M 4b		
	18	M6 (3m)	4	26	54,358	1418	IRCM 83 / 112 M 4b		
20	M6 (3m)	5,5	29	48,314	1733	IRCM 83 / 132 S 4c			
24	M6 (3m)	5,5	35	39,796	1427	IRCM 83 / 132 S 4c			
29	M6 (3m)	7,5	42	33,003	1614	IRCM 83 / 132 M 4b			
35	M6 (3m)	9,2	51	27,535	1652	IRCM 83 / 132 M 4c			





D _T Tambur Çapı Drum Diameter <i>Diamètre de l'arbre</i> [mm]	V _h Kaldırma Hızı Lifting Speeds <i>Vitesse de levage</i> [m/min]	Vinç Sınıfı Crane Class <i>Classification de l'application de levage</i> ISO (FEM)	P ₁ Motor Gücü Power <i>Puissance</i> [kW]	n ₂ Çıkış Devri Output Speeds <i>Vitesse de sortie</i> [r.p.m]	i Tahvil Ratio <i>Rapport de réduction</i>	M ₂ Çıkış Momenti Output Torque <i>Couple de sortie</i>	Tip Type <i>Typ</i>		 kg
Ø230	6,2	M8 (5m)	1,5	8,6	162,826	1593	IRCM 93 / 90 L 4a		
	6,9	M8 (5m)	1,5	9,5	146,946	1437	IRCM 93 / 90 L 4a		
	7,2	M8 (5m)	2,2	10	133,419	1914	IRCM 93 / 100 L 4a		
	9,4	M8 (5m)	2,2	13	111,602	1601	IRCM 93 / 100 L 4a		
	12	M8 (5m)	3	16	87,936	1720	IRCM 93 / 100 L 4b		
	13	M8 (5m)	3	18	79,841	1562	IRCM 93 / 100 L 4b		
	15	M8 (5m)	4	21	66,785	1742	IRCM 93 / 112 M 4b		
	17	M8 (5m)	4	23	61,444	1603	IRCM 93 / 112 M 4b		
	19	M8 (5m)	5,5	26	54,545	1956	IRCM 93 / 132 S 4c		
	22	M8 (5m)	5,5	31	44,753	1605	IRCM 93 / 132 S 4c		
	27	M8 (5m)	7,5	38	37,199	1819	IRCM 93 / 132 M 4b		
	30	M8 (5m)	7,5	41	34,034	1665	IRCM 93 / 132 M 4b		
	32	M8 (5m)	7,5	45	31,194	1526	IRCM 93 / 132 M 4b		
	7,2	M6 (3m)	2,2	10	133,509	1915	IRCM 83 / 100 L 4a		
	8,7	M6 (3m)	2,2	12	121,711	1746	IRCM 83 / 100 L 4a		
	10	M6 (3m)	2,2	14	102,407	1469	IRCM 83 / 100 L 4a		
	11	M6 (3m)	3	15	92,330	1806	IRCM 83 / 100 L 4b		
	14	M6 (3m)	3	19	75,613	1479	IRCM 83 / 100 L 4b		
	17	M6 (3m)	4	23	60,299	1573	IRCM 83 / 112 M 4b		
	19	M6 (3m)	5,5	26	54,358	1950	IRCM 83 / 132 S 4c		
21	M6 (3m)	5,5	29	48,314	1733	IRCM 83 / 132 S 4c			
25	M6 (3m)	5,5	35	39,796	1427	IRCM 83 / 132 S 4c			
30	M6 (3m)	7,5	42	33,003	1614	IRCM 83 / 132 M 4b			
37	M5 (2m)	9,2	51	27,535	1652	IRCM 83 / 132 M 4c			
Ø240	6,5	M8 (5m)	1,5	8,6	162,826	1593	IRCM 93 / 90 L 4a		
	7,2	M8 (5m)	2,2	9,5	146,946	2108	IRCM 93 / 100 L 4a		
	7,5	M8 (5m)	2,2	10	133,419	1914	IRCM 93 / 100 L 4a		
	9,8	M8 (5m)	2,2	13	111,602	1601	IRCM 93 / 100 L 4a		
	12	M8 (5m)	3	16	87,936	1720	IRCM 93 / 100 L 4b		
	14	M8 (5m)	3	18	79,841	1562	IRCM 93 / 100 L 4b		
	16	M8 (5m)	4	21	66,785	1742	IRCM 93 / 112 M 4b		
	17	M8 (5m)	4	23	61,444	1603	IRCM 93 / 112 M 4b		
	20	M8 (5m)	5,5	26	54,545	1956	IRCM 93 / 132 S 4c		
	23	M8 (5m)	5,5	31	44,753	1605	IRCM 93 / 132 S 4c		
	29	M8 (5m)	7,5	38	37,199	1819	IRCM 93 / 132 M 4b		
	31	M8 (5m)	7,5	41	34,034	1665	IRCM 93 / 132 M 4b		
	34	M8 (5m)	7,5	45	31,194	1526	IRCM 93 / 132 M 4b		
	7,5	M6 (3m)	2,2	10	133,509	1915	IRCM 83 / 100 L 4a		
	9,0	M6 (3m)	2,2	12	121,711	1746	IRCM 83 / 100 L 4a		
	11	M6 (3m)	3	14	102,407	2003	IRCM 83 / 100 L 4b		
	11	M6 (3m)	3	15	92,330	1806	IRCM 83 / 100 L 4b		
	14	M6 (3m)	4	19	75,613	1972	IRCM 83 / 112 M 4b		
	17	M6 (3m)	4	23	60,299	1573	IRCM 83 / 112 M 4b		
	20	M6 (3m)	5,5	26	54,358	1950	IRCM 83 / 132 S 4c		
22	M6 (3m)	5,5	29	48,314	1733	IRCM 83 / 132 S 4c			
26	M6 (3m)	7,5	35	39,796	1946	IRCM 83 / 132 M 4b			
32	M5 (2m)	7,5	42	33,003	1614	IRCM 83 / 132 M 4b			
38	M5 (2m)	9,2	51	27,535	1652	IRCM 83 / 132 M 4c			



Vinç sistemleri kaldırma redüktörleri güç ve devir tabloları / Power and ratio table for hoisting applications / Tableau de classification des couples et rapports de réduction pour les applications de levage



D _T Tambur Çapı Drum Diameter <i>Diamètre de l'arbre</i> [mm]	V _h Kaldırma Hızı Lifting Speeds <i>Vitesse de levage</i> [m/min]	Vinç Sınıfı Crane Class <i>Classification de l'application de levage</i> ISO (FEM)	P ₁ Motor Gücü Power <i>Puissance</i> [kW]	n ₂ Çıkış Devri Output Speeds <i>Vitesse de sortie</i> [r.p.m]	i Tahvil Ratio <i>Rapport de réduction</i>	M ₂ Çıkış Momenti Output Torque <i>Couple de sortie</i>	Tip Type <i>Typ</i>		 kg
Ø110	2,1	M8 (5m)	0,55	12	120,792	433	IRCM 73 / 80 M 4a		
	2,2	M8 (5m)	0,55	13	107,423	385	IRCM 73 / 80 M 4a		
	2,6	M8 (5m)	0,75	15	96,194	470	IRCM 73 / 80 M 4b		
	2,8	M8 (5m)	0,75	16	86,628	424	IRCM 73 / 80 M 4b		
	3,3	M8 (5m)	0,75	19	73,889	361	IRCM 73 / 80 M 4b		
	3,6	M8 (5m)	1,1	21	65,252	468	IRCM 73 / 90 S 4a		
	4,1	M8 (5m)	1,1	24	57,996	416	IRCM 73 / 90 S 4a		
	4,7	M8 (5m)	1,1	27	51,846	372	IRCM 73 / 90 S 4a		
	5,7	M8 (5m)	1,5	33	41,848	409	IRCM 73 / 90 L 4a		
	6,7	M8 (5m)	1,5	39	35,564	348	IRCM 73 / 90 L 4a		
	7,6	M8 (5m)	2,2	44	32,098	461	IRCM 73 / 100 L 4a		
	9,2	M8 (5m)	2,2	53	26,291	377	IRCM 73 / 100 L 4a		
10	M8 (5m)	2,2	59	23,834	342	IRCM 73 / 100 L 4a			
Ø120	2,3	M8 (5m)	0,55	12	120,792	433	IRCM 73 / 80 M 4a		
	2,4	M8 (5m)	0,55	13	107,423	385	IRCM 73 / 80 M 4a		
	2,8	M8 (5m)	0,75	15	96,194	470	IRCM 73 / 80 M 4b		
	3,0	M8 (5m)	0,75	16	86,628	424	IRCM 73 / 80 M 4b		
	3,6	M8 (5m)	1,1	19	73,889	530	IRCM 73 / 90 S 4a		
	4,0	M8 (5m)	1,1	21	65,252	468	IRCM 73 / 90 S 4a		
	4,5	M8 (5m)	1,1	24	57,996	416	IRCM 73 / 90 S 4a		
	5,1	M8 (5m)	1,1	27	51,846	372	IRCM 73 / 90 S 4a		
	6,2	M8 (5m)	1,5	33	41,848	409	IRCM 73 / 90 L 4a		
	7,3	M8 (5m)	2,2	39	35,564	510	IRCM 73 / 100 L 4a		
	8,3	M8 (5m)	2,2	44	32,098	461	IRCM 73 / 100 L 4a		
	10	M8 (5m)	2,2	53	26,291	377	IRCM 73 / 100 L 4a		
11	M8 (5m)	3	59	23,834	466	IRCM 73 / 100 L 4b			
Ø130	2,4	M8 (5m)	0,55	12	120,792	433	IRCM 73 / 80 M 4a		
	2,7	M8 (5m)	0,75	13	107,423	525	IRCM 73 / 80 M 4b		
	3,1	M8 (5m)	0,75	15	96,194	470	IRCM 73 / 80 M 4b		
	3,3	M8 (5m)	0,75	16	86,628	424	IRCM 73 / 80 M 4b		
	3,9	M8 (5m)	1,1	19	73,889	530	IRCM 73 / 90 S 4a		
	4,3	M8 (5m)	1,1	21	65,252	468	IRCM 73 / 90 S 4a		
	4,9	M8 (5m)	1,1	24	57,996	416	IRCM 73 / 90 S 4a		
	5,5	M8 (5m)	1,5	27	51,846	507	IRCM 73 / 90 L 4a		
	6,7	M8 (5m)	1,5	33	41,848	409	IRCM 73 / 90 L 4a		
	8,0	M8 (5m)	2,2	39	35,564	510	IRCM 73 / 100 L 4a		
	9,0	M8 (5m)	2,2	44	32,098	461	IRCM 73 / 100 L 4a		
	11	M8 (5m)	3	53	26,291	514	IRCM 73 / 100 L 4b		
12	M8 (5m)	3	59	23,834	466	IRCM 73 / 100 L 4b			
Ø140	2,6	M8 (5m)	0,75	12	120,792	591	IRCM 73 / 80 M 4b		
	2,9	M8 (5m)	0,75	13	107,423	525	IRCM 73 / 80 M 4b		
	3,3	M8 (5m)	0,75	15	96,194	470	IRCM 73 / 80 M 4b		
	3,5	M8 (5m)	1,1	16	86,628	621	IRCM 73 / 90 S 4a		
	4,2	M8 (5m)	1,1	19	73,889	530	IRCM 73 / 90 S 4a		
	4,6	M8 (5m)	1,1	21	65,252	468	IRCM 73 / 90 S 4a		
	5,3	M8 (5m)	1,5	24	57,996	567	IRCM 73 / 90 L 4a		
	5,9	M8 (5m)	1,5	27	51,846	507	IRCM 73 / 90 L 4a		
	7,3	M8 (5m)	2,2	33	41,848	600	IRCM 73 / 100 L 4a		
	8,6	M8 (5m)	2,2	39	35,564	510	IRCM 73 / 100 L 4a		
	9,7	M8 (5m)	2,2	44	32,098	461	IRCM 73 / 100 L 4a		
	12	M8 (5m)	3	53	26,291	514	IRCM 73 / 100 L 4b		
	13	M8 (5m)	3	59	23,834	466	IRCM 73 / 100 L 4b		





D _T Tambur Çapı Drum Diameter <i>Diamètre de l'arbre</i> [mm]	V _h Kaldırma Hızı Lifting Speeds <i>Vitesse de levage</i> [m/min]	Vinç Sınıfı Crane Class <i>Classification de l'application de levage</i> ISO (FEM)	P ₁ Motor Gücü Power <i>Puissance</i> [kW]	n ₂ Çıkış Devri Output Speeds <i>Vitesse de sortie</i> [r.p.m]	i Tahvil Ratio <i>Rapport de réduction</i>	M ₂ Çıkış Momenti Output Torque <i>Couple de sortie</i>	Tip Type <i>Typ</i>		 kg
Ø150	2,8	M8 (5m)	0,75	12	120,792	591	IRCM 73 / 80 M 4b		
	3,1	M8 (5m)	0,75	13	107,423	525	IRCM 73 / 80 M 4b		
	3,5	M8 (5m)	1,1	15	96,194	690	IRCM 73 / 90 S 4a		
	3,8	M8 (5m)	1,1	16	86,628	621	IRCM 73 / 90 S 4a		
	4,5	M8 (5m)	1,1	19	73,889	530	IRCM 73 / 90 S 4a		
	4,9	M8 (5m)	1,1	21	65,252	468	IRCM 73 / 90 S 4a		
	5,7	M8 (5m)	1,5	24	57,996	567	IRCM 73 / 90 L 4a		
	6,4	M8 (5m)	1,5	27	51,846	507	IRCM 73 / 90 L 4a		
	7,8	M8 (5m)	2,2	33	41,848	600	IRCM 73 / 100 L 4a		
	9,2	M8 (5m)	2,2	39	35,564	510	IRCM 73 / 100 L 4a		
	10	M8 (5m)	3	44	32,098	628	IRCM 73 / 100 L 4b		
	12	M8 (5m)	3	53	26,291	514	IRCM 73 / 100 L 4b		
	14	M8 (5m)	3	59	23,834	466	IRCM 73 / 100 L 4b		
Ø160	3,0	M8 (5m)	0,75	12	120,792	591	IRCM 73 / 80 M 4b		
	3,3	M8 (5m)	0,75	13	107,423	525	IRCM 73 / 80 M 4b		
	3,8	M8 (5m)	1,1	15	96,194	690	IRCM 73 / 90 S 4a		
	4,0	M8 (5m)	1,1	16	86,628	621	IRCM 73 / 90 S 4a		
	4,8	M8 (5m)	1,1	19	73,889	530	IRCM 73 / 90 S 4a		
	5,3	M8 (5m)	1,5	21	65,252	638	IRCM 73 / 90 L 4a		
	6,0	M8 (5m)	1,5	24	57,996	567	IRCM 73 / 90 L 4a		
	6,8	M8 (5m)	1,5	27	51,846	507	IRCM 73 / 90 L 4a		
	8,3	M8 (5m)	2,2	33	41,848	600	IRCM 73 / 100 L 4a		
	9,8	M8 (5m)	2,2	39	35,564	510	IRCM 73 / 100 L 4a		
	11	M8 (5m)	3	44	32,098	628	IRCM 73 / 100 L 4b		
	13	M7 (4m)	3	53	26,291	514	IRCM 73 / 100 L 4b		
	15	M7 (4m)	4	59	23,834	622	IRCM 73 / 112 M 4b		
Ø170	3,2	M8 (5m)	0,75	12	120,792	591	IRCM 73 / 80 M 4b		
	3,5	M8 (5m)	0,75	13	107,423	525	IRCM 73 / 80 M 4b		
	4,0	M8 (5m)	1,1	15	96,194	690	IRCM 73 / 90 S 4a		
	4,3	M8 (5m)	1,1	16	86,628	621	IRCM 73 / 90 S 4a		
	5,1	M8 (5m)	1,1	19	73,889	530	IRCM 73 / 90 S 4a		
	5,6	M8 (5m)	1,5	21	65,252	638	IRCM 73 / 90 L 4a		
	6,4	M8 (5m)	1,5	24	57,996	567	IRCM 73 / 90 L 4a		
	7,2	M8 (5m)	2,2	27	51,846	744	IRCM 73 / 100 L 4a		
	8,8	M8 (5m)	2,2	33	41,848	600	IRCM 73 / 100 L 4a		
	10	M7 (4m)	3	39	35,564	696	IRCM 73 / 100 L 4b		
	12	M7 (4m)	3	44	32,098	628	IRCM 73 / 100 L 4b		
	14	M7 (4m)	4	53	26,291	686	IRCM 73 / 112 M 4b		
	16	M7 (4m)	4	59	23,834	622	IRCM 73 / 112 M 4b		
Ø180	3,4	M8 (5m)	0,75	12	120,792	591	IRCM 73 / 80 M 4b		
	3,7	M8 (5m)	1,1	13	107,423	771	IRCM 73 / 90 S 4a		
	4,2	M7 (4m)	1,1	15	96,194	690	IRCM 73 / 90 S 4a		
	4,5	M7 (4m)	1,1	16	86,628	621	IRCM 73 / 90 S 4a		
	5,4	M7 (4m)	1,5	19	73,889	723	IRCM 73 / 90 L 4a		
	5,9	M7 (4m)	1,5	21	65,252	638	IRCM 73 / 90 L 4a		
	6,8	M7 (4m)	1,5	24	57,996	567	IRCM 73 / 90 L 4a		
	7,6	M7 (4m)	2,2	27	51,846	744	IRCM 73 / 100 L 4a		
	9,3	M7 (4m)	2,2	33	41,848	600	IRCM 73 / 100 L 4a		
	11	M7 (4m)	3	39	35,564	696	IRCM 73 / 100 L 4b		
	12	M7 (4m)	3	44	32,098	628	IRCM 73 / 100 L 4b		
	15	M7 (4m)	4	53	26,291	686	IRCM 73 / 112 M 4b		
	17	M7 (4m)	4	59	23,834	622	IRCM 73 / 112 M 4b		





Vinç sistemleri kaldırma redüktörleri güç ve devir tabloları / Power and ratio table for hoisting applications / Tableau de classification des couples et rapports de réduction pour les applications de levage

D _T Tambur Çapı Drum Diameter <i>Diamètre de l'arbre</i> [mm]	V _h Kaldırma Hızı Lifting Speeds <i>Vitesse de levage</i> [m/min]	Vinç Sınıfı Crane Class <i>Classification de l'application de levage</i> ISO (FEM)	P ₁ Motor Gücü Power <i>Puissance</i> [kW]	n ₂ Çıkış Devri Output Speeds <i>Vitesse de sortie</i> [r.p.m]	i Tahvil Ratio <i>Rapport de réduction</i>	M ₂ Çıkış Momenti Output Torque <i>Couple de sortie</i>	Tip Type <i>Typ</i>		 kg
Ø170	4,6	M8 (5m)	1,5	8,6	162,826	1593	IRCM 93 / 90 L 4a		
	5,1	M8 (5m)	1,5	9,5	146,946	1437	IRCM 93 / 90 L 4a		
	5,3	M8 (5m)	1,5	10	133,419	1305	IRCM 93 / 90 L 4a		
	6,9	M8 (5m)	2,2	13	111,602	1601	IRCM 93 / 100 L 4a		
	8,5	M8 (5m)	3	16	87,936	1720	IRCM 93 / 100 L 4b		
	9,6	M8 (5m)	3	18	79,841	1562	IRCM 93 / 100 L 4b		
	11	M8 (5m)	4	21	66,785	1742	IRCM 93 / 112 M 4b		
	12	M8 (5m)	4	23	61,444	1603	IRCM 93 / 112 M 4b		
	14	M8 (5m)	4	26	54,545	1423	IRCM 93 / 112 M 4b		
	17	M8 (5m)	5,5	31	44,753	1605	IRCM 93 / 132 S 4c		
	20	M8 (5m)	7,5	38	37,199	1819	IRCM 93 / 132 M 4b		
	22	M8 (5m)	7,5	41	34,034	1665	IRCM 93 / 132 M 4b		
	24	M8 (5m)	7,5	45	31,194	1526	IRCM 93 / 132 M 4b		
	5,3	M7 (4m)	1,5	10	133,509	1306	IRCM 83 / 90 L 4a		
	6,4	M7 (4m)	2,2	12	121,711	1746	IRCM 83 / 100 L 4a		
	7,5	M7 (4m)	2,2	14	102,407	1469	IRCM 83 / 100 L 4a		
	8,0	M7 (4m)	3	15	92,330	1806	IRCM 83 / 100 L 4b		
	10	M6 (3m)	3	19	75,613	1479	IRCM 83 / 100 L 4b		
	12	M6 (3m)	4	23	60,299	1573	IRCM 83 / 112 M 4b		
	14	M6 (3m)	4	26	54,358	1418	IRCM 83 / 112 M 4b		
15	M6 (3m)	5,5	29	48,314	1733	IRCM 83 / 132 S 4c			
19	M6 (3m)	5,5	35	39,796	1427	IRCM 83 / 132 S 4c			
22	M6 (3m)	7,5	42	33,003	1614	IRCM 83 / 132 M 4b			
27	M6 (3m)	7,5	51	27,535	1347	IRCM 83 / 132 M 4b			
Ø180	4,9	M8 (5m)	1,5	8,6	162,826	1593	IRCM 93 / 90 L 4a		
	5,4	M8 (5m)	1,5	9,5	146,946	1437	IRCM 93 / 90 L 4a		
	5,7	M8 (5m)	2,2	10	133,419	1914	IRCM 93 / 100 L 4a		
	7,3	M8 (5m)	2,2	13	111,602	1601	IRCM 93 / 100 L 4a		
	9,0	M8 (5m)	3	16	87,936	1720	IRCM 93 / 100 L 4b		
	10	M8 (5m)	3	18	79,841	1562	IRCM 93 / 100 L 4b		
	12	M8 (5m)	4	21	66,785	1742	IRCM 93 / 112 M 4b		
	13	M8 (5m)	4	23	61,444	1603	IRCM 93 / 112 M 4b		
	15	M8 (5m)	5,5	26	54,545	1956	IRCM 93 / 132 S 4c		
	18	M8 (5m)	5,5	31	44,753	1605	IRCM 93 / 132 S 4c		
	21	M8 (5m)	7,5	38	37,199	1819	IRCM 93 / 132 M 4b		
	23	M8 (5m)	7,5	41	34,034	1665	IRCM 93 / 132 M 4b		
	25	M8 (5m)	7,5	45	31,194	1526	IRCM 93 / 132 M 4b		
	5,7	M6 (3m)	2,2	10	133,509	1915	IRCM 83 / 100 L 4a		
	6,8	M6 (3m)	2,2	12	121,711	1746	IRCM 83 / 100 L 4a		
	7,9	M6 (3m)	2,2	14	102,407	1469	IRCM 83 / 100 L 4a		
	8,5	M6 (3m)	3	15	92,330	1806	IRCM 83 / 100 L 4b		
	11	M6 (3m)	3	19	75,613	1479	IRCM 83 / 100 L 4b		
	13	M6 (3m)	4	23	60,299	1573	IRCM 83 / 112 M 4b		
	15	M6 (3m)	5,5	26	54,358	1950	IRCM 83 / 132 S 4c		
16	M6 (3m)	5,5	29	48,314	1733	IRCM 83 / 132 S 4c			
20	M6 (3m)	5,5	35	39,796	1427	IRCM 83 / 132 S 4c			
24	M6 (3m)	7,5	42	33,003	1614	IRCM 83 / 132 M 4b			
29	M5 (2m)	9,2	51	27,535	1652	IRCM 83 / 132 M 4c			





D _T Tambur Çapı Drum Diameter <i>Diamètre de l'arbre</i> [mm]	V _h Kaldırma Hızı Lifting Speeds <i>Vitesse de levage</i> [m/min]	Vinç Sınıfı Crane Class <i>Classification de l'application de levage</i> ISO (FEM)	P ₁ Motor Gücü Power <i>Puissance</i> [kW]	n ₂ Çıkış Devri Output Speeds <i>Vitesse de sortie</i> [r.p.m]	i Tahvil Ratio <i>Rapport de réduction</i>	M ₂ Çıkış Momenti Output Torque <i>Couple de sortie</i>	Tip Type <i>Typ</i>		 kg
Ø190	5,1	M8 (5m)	1,5	8,6	162,826	1593	IRCM 93 / 90 L 4a		
	5,7	M8 (5m)	2,2	9,5	146,946	2108	IRCM 93 / 100 L 4a		
	6,0	M8 (5m)	2,2	10	133,419	1914	IRCM 93 / 100 L 4a		
	7,8	M8 (5m)	2,2	13	111,602	1601	IRCM 93 / 100 L 4a		
	9,5	M8 (5m)	3	16	87,936	1720	IRCM 93 / 100 L 4b		
	11	M8 (5m)	3	18	79,841	1562	IRCM 93 / 100 L 4b		
	13	M8 (5m)	4	21	66,785	1742	IRCM 93 / 112 M 4b		
	14	M8 (5m)	4	23	61,444	1603	IRCM 93 / 112 M 4b		
	16	M8 (5m)	5,5	26	54,545	1956	IRCM 93 / 132 S 4c		
	18	M8 (5m)	5,5	31	44,753	1605	IRCM 93 / 132 S 4c		
	23	M8 (5m)	7,5	38	37,199	1819	IRCM 93 / 132 M 4b		
	24	M8 (5m)	7,5	41	34,034	1665	IRCM 93 / 132 M 4b		
	27	M8 (5m)	7,5	45	31,194	1526	IRCM 93 / 132 M 4b		
	6,0	M6 (3m)	2,2	10	133,509	1915	IRCM 83 / 100 L 4a		
	7,2	M6 (3m)	2,2	12	121,711	1746	IRCM 83 / 100 L 4a		
	8,4	M6 (3m)	3	14	102,407	2003	IRCM 83 / 100 L 4b		
	8,9	M6 (3m)	3	15	92,330	1806	IRCM 83 / 100 L 4b		
	11	M6 (3m)	4	19	75,613	1972	IRCM 83 / 112 M 4b		
	14	M6 (3m)	4	23	60,299	1573	IRCM 83 / 112 M 4b		
	16	M6 (3m)	5,5	26	54,358	1950	IRCM 83 / 132 S 4c		
17	M6 (3m)	5,5	29	48,314	1733	IRCM 83 / 132 S 4c			
21	M6 (3m)	7,5	35	39,796	1946	IRCM 83 / 132 M 4b			
25	M5 (2m)	7,5	42	33,003	1614	IRCM 83 / 132 M 4b			
30	M5 (2m)	9,2	51	27,535	1652	IRCM 83 / 132 M 4c			
Ø200	5,4	M8 (5m)	1,5	8,6	162,826	1593	IRCM 93 / 90 L 4a		
	6,0	M8 (5m)	2,2	9,5	146,946	2108	IRCM 93 / 100 L 4a		
	6,3	M8 (5m)	2,2	10	133,419	1914	IRCM 93 / 100 L 4a		
	8,2	M8 (5m)	3	13	111,602	2183	IRCM 93 / 100 L 4b		
	10	M8 (5m)	3	16	87,936	1720	IRCM 93 / 100 L 4b		
	11	M8 (5m)	4	18	79,841	2083	IRCM 93 / 112 M 4b		
	13	M8 (5m)	4	21	66,785	1742	IRCM 93 / 112 M 4b		
	14	M8 (5m)	4	23	61,444	1603	IRCM 93 / 112 M 4b		
	16	M8 (5m)	5,5	26	54,545	1956	IRCM 93 / 132 S 4c		
	19	M8 (5m)	5,5	31	44,753	1605	IRCM 93 / 132 S 4c		
	24	M8 (5m)	7,5	38	37,199	1819	IRCM 93 / 132 M 4b		
	26	M8 (5m)	7,5	41	34,034	1665	IRCM 93 / 132 M 4b		
	28	M8 (5m)	9,2	45	31,194	1872	IRCM 93 / 132 M 4c		
	6,3	M6 (3m)	2,2	10	133,509	1915	IRCM 83 / 100 L 4a		
	7,5	M6 (3m)	2,2	12	121,711	1746	IRCM 83 / 100 L 4a		
	8,8	M6 (3m)	3	14	102,407	2003	IRCM 83 / 100 L 4b		
	9,4	M6 (3m)	3	15	92,330	1806	IRCM 83 / 100 L 4b		
	12	M6 (3m)	4	19	75,613	1972	IRCM 83 / 112 M 4b		
	14	M6 (3m)	4	23	60,299	1573	IRCM 83 / 112 M 4b		
	16	M6 (3m)	5,5	26	54,358	1950	IRCM 83 / 132 S 4c		
18	M5 (2m)	5,5	29	48,314	1733	IRCM 83 / 132 S 4c			
22	M5 (2m)	7,5	35	39,796	1946	IRCM 83 / 132 M 4b			
26	M5 (2m)	7,5	42	33,003	1614	IRCM 83 / 132 M 4b			
32	M5 (2m)	9,2	51	27,535	1652	IRCM 83 / 132 M 4c			





D _T Tambur Çapı Drum Diameter <i>Diamètre de l'arbre</i> [mm]	V _h Kaldırma Hızı Lifting Speeds <i>Vitesse de levage</i> [m/min]	Vinç Sınıfı Crane Class <i>Classification de l'application de levage</i> ISO (FEM)	P ₁ Motor Gücü Power <i>Puissance</i> [kW]	n ₂ Çıkış Devri Output Speeds <i>Vitesse de sortie</i> [r.p.m]	i Tahvil Ratio <i>Rapport de réduction</i>	M ₂ Çıkış Momenti Output Torque <i>Couple de sortie</i>	Tip Type <i>Typ</i>		 kg
Ø210	5,7	M8 (5m)	2,2	8,6	162,826	2336	IRCM 93 / 100 L 4a		
	6,3	M8 (5m)	2,2	9,5	146,946	2108	IRCM 93 / 100 L 4a		
	6,6	M8 (5m)	2,2	10	133,419	1914	IRCM 93 / 100 L 4a		
	8,6	M8 (5m)	3	13	111,602	2183	IRCM 93 / 100 L 4b		
	11	M8 (5m)	3	16	87,936	1720	IRCM 93 / 100 L 4b		
	12	M8 (5m)	4	18	79,841	2083	IRCM 93 / 112 M 4b		
	14	M8 (5m)	4	21	66,785	1742	IRCM 93 / 112 M 4b		
	15	M8 (5m)	5,5	23	61,444	2204	IRCM 93 / 132 S 4c		
	17	M8 (5m)	5,5	26	54,545	1956	IRCM 93 / 132 S 4c		
	20	M8 (5m)	7,5	31	44,753	2189	IRCM 93 / 132 M 4b		
	25	M8 (5m)	7,5	38	37,199	1819	IRCM 93 / 132 M 4b		
	27	M8 (5m)	7,5	41	34,034	1665	IRCM 93 / 132 M 4b		
	30	M8 (5m)	9,2	45	31,194	1872	IRCM 93 / 132 M 4c		
	6,6	M6 (3m)	2,2	10	133,509	1915	IRCM 83 / 100 L 4a		
	7,9	M6 (3m)	2,2	12	121,711	1746	IRCM 83 / 100 L 4a		
	9,2	M5 (2m)	3	14	102,407	2003	IRCM 83 / 100 L 4b		
	9,9	M5 (2m)	3	15	92,330	1806	IRCM 83 / 100 L 4b		
	13	M5 (2m)	4	19	75,613	1972	IRCM 83 / 112 M 4b		
	15	M5 (2m)	5,5	23	60,299	2163	IRCM 83 / 132 S 4c		
	17	M5 (2m)	5,5	26	54,358	1950	IRCM 83 / 132 S 4c		
19	M5 (2m)	5,5	29	48,314	1733	IRCM 83 / 132 S 4c			
23	M5 (2m)	7,5	35	39,796	1946	IRCM 83 / 132 M 4b			
28	M4 (1Am)	9,2	42	33,003	1980	IRCM 83 / 132 M 4c			
34	M4 (1Am)	11	51	27,535	1975	IRCM 83 / 160 M 4b			
Ø220	5,9	M8 (5m)	2,2	8,6	162,826	2336	IRCM 93 / 100 L 4a		
	6,6	M8 (5m)	2,2	9,5	146,946	2108	IRCM 93 / 100 L 4a		
	6,9	M8 (5m)	2,2	10	133,419	1914	IRCM 93 / 100 L 4a		
	9,0	M8 (5m)	3	13	111,602	2183	IRCM 93 / 100 L 4b		
	11	M8 (5m)	4	16	87,936	2294	IRCM 93 / 112 M 4b		
	12	M8 (5m)	4	18	79,841	2083	IRCM 93 / 112 M 4b		
	15	M8 (5m)	4	21	66,785	1742	IRCM 93 / 112 M 4b		
	16	M8 (5m)	5,5	23	61,444	2204	IRCM 93 / 132 S 4c		
	18	M8 (5m)	5,5	26	54,545	1956	IRCM 93 / 132 S 4c		
	21	M8 (5m)	7,5	31	44,753	2189	IRCM 93 / 132 M 4b		
	26	M8 (5m)	7,5	38	37,199	1819	IRCM 93 / 132 M 4b		
	28	M8 (5m)	9,2	41	34,034	2042	IRCM 93 / 132 M 4c		
	31	M8 (5m)	9,2	45	31,194	1872	IRCM 93 / 132 M 4c		
	6,9	M5 (2m)	2,2	10	133,509	1915	IRCM 83 / 100 L 4a		
	8,3	M5 (2m)	3	12	121,711	2381	IRCM 83 / 100 L 4b		
	9,7	M5 (2m)	3	14	102,407	2003	IRCM 83 / 100 L 4b		
	10	M5 (2m)	3	15	92,330	1806	IRCM 83 / 100 L 4b		
	13	M5 (2m)	4	19	75,613	1972	IRCM 83 / 112 M 4b		
	16	M5 (2m)	5,5	23	60,299	2163	IRCM 83 / 132 S 4c		
	18	M5 (2m)	5,5	26	54,358	1950	IRCM 83 / 132 S 4c		
20	M4 (1Am)	7,5	29	48,314	2363	IRCM 83 / 132 M 4b			
24	M4 (1Am)	7,5	35	39,796	1946	IRCM 83 / 132 M 4b			
29	M4 (1Am)	9,2	42	33,003	1980	IRCM 83 / 132 M 4c			





D _T Tambur Çapı Drum Diameter <i>Diamètre de l'arbre</i> [mm]	V _h Kaldırma Hızı Lifting Speeds <i>Vitesse de levage</i> [m/min]	Vinç Sınıfı Crane Class <i>Classification de l'application de levage</i> ISO (FEM)	P ₁ Motor Gücü Power <i>Puissance</i> [kW]	n ₂ Çıkış Devri Output Speeds <i>Vitesse de sortie</i> [r.p.m]	i Tahvil Ratio <i>Rapport de réduction</i>	M ₂ Çıkış Momenti Output Torque <i>Couple de sortie</i>	Tip Type <i>Typ</i>		 kg
Ø230	6,2	M8 (5m)	2,2	8,6	162,826	2336	IRCM 93 / 100 L 4a		
	6,9	M8 (5m)	2,2	9,5	146,946	2108	IRCM 93 / 100 L 4a		
	7,2	M8 (5m)	2,2	10	133,419	1914	IRCM 93 / 100 L 4a		
	9,4	M8 (5m)	3	13	111,602	2183	IRCM 93 / 100 L 4b		
	12	M8 (5m)	4	16	87,936	2294	IRCM 93 / 112 M 4b		
	13	M8 (5m)	4	18	79,841	2083	IRCM 93 / 112 M 4b		
	15	M8 (5m)	5,5	21	66,785	2395	IRCM 93 / 132 S 4c		
	17	M8 (5m)	5,5	23	61,444	2204	IRCM 93 / 132 S 4c		
	19	M8 (5m)	5,5	26	54,545	1956	IRCM 93 / 132 S 4c		
	22	M8 (5m)	7,5	31	44,753	2189	IRCM 93 / 132 M 4b		
	27	M8 (5m)	9,2	38	37,199	2232	IRCM 93 / 132 M 4c		
	30	M8 (5m)	9,2	41	34,034	2042	IRCM 93 / 132 M 4c		
	32	M8 (5m)	9,2	45	31,194	1872	IRCM 93 / 132 M 4c		
	7,2	M5 (2m)	2,2	10	133,509	1915	IRCM 83 / 100 L 4a		
	8,7	M5 (2m)	3	12	121,711	2381	IRCM 83 / 100 L 4b		
	10	M5 (2m)	3	14	102,407	2003	IRCM 83 / 100 L 4b		
	11	M5 (2m)	3	15	92,330	1806	IRCM 83 / 100 L 4b		
	14	M4 (1Am)	4	19	75,613	1972	IRCM 83 / 112 M 4b		
	17	M4 (1Am)	5,5	23	60,299	2163	IRCM 83 / 132 S 4c		
	19	M4 (1Am)	5,5	26	54,358	1950	IRCM 83 / 132 S 4c		
21	M4 (1Am)	7,5	29	48,314	2363	IRCM 83 / 132 M 4b			
25	M4 (1Am)	7,5	35	39,796	1946	IRCM 83 / 132 M 4b			
30	M4 (1Am)	9,2	42	33,003	1980	IRCM 83 / 132 M 4c			
37	M3 (1Bm)	11	51	27,535	1975	IRCM 83 / 160 M 4b			
Ø240	6,5	M8 (5m)	2,2	8,6	162,826	2336	IRCM 93 / 100 L 4a		
	7,2	M8 (5m)	2,2	9,5	146,946	2108	IRCM 93 / 100 L 4a		
	7,5	M8 (5m)	2,2	10	133,419	1914	IRCM 93 / 100 L 4a		
	9,8	M8 (5m)	3	13	111,602	2183	IRCM 93 / 100 L 4b		
	12	M8 (5m)	4	16	87,936	2294	IRCM 93 / 112 M 4b		
	14	M8 (5m)	4	18	79,841	2083	IRCM 93 / 112 M 4b		
	16	M8 (5m)	5,5	21	66,785	2395	IRCM 93 / 132 S 4c		
	17	M8 (5m)	5,5	23	61,444	2204	IRCM 93 / 132 S 4c		
	20	M8 (5m)	5,5	26	54,545	1956	IRCM 93 / 132 S 4c		
	23	M8 (5m)	7,5	31	44,753	2189	IRCM 93 / 132 M 4b		
	29	M8 (5m)	9,2	38	37,199	2232	IRCM 93 / 132 M 4c		
	31	M8 (5m)	9,2	41	34,034	2042	IRCM 93 / 132 M 4c		
	34	M8 (5m)	11	45	31,194	2238	IRCM 93 / 160 M 4b		
	7,5	M5 (2m)	2,2	10	133,509	1915	IRCM 83 / 100 L 4a		
	9,0	M4 (1Am)	3	12	121,711	2381	IRCM 83 / 100 L 4b		
	11	M4 (1Am)	3	14	102,407	2003	IRCM 83 / 100 L 4b		
	11	M4 (1Am)	4	15	92,330	2408	IRCM 83 / 112 M 4b		
	14	M4 (1Am)	4	19	75,613	1972	IRCM 83 / 112 M 4b		
	17	M4 (1Am)	5,5	23	60,299	2163	IRCM 83 / 132 S 4c		
	20	M4 (1Am)	5,5	26	54,358	1950	IRCM 83 / 132 S 4c		
22	M4 (1Am)	7,5	29	48,314	2363	IRCM 83 / 132 M 4b			
26	M3 (1Bm)	7,5	35	39,796	1946	IRCM 83 / 132 M 4b			
32	M3 (1Bm)	9,2	42	33,003	1980	IRCM 83 / 132 M 4c			



Vinç sistemleri kaldırma redüktörleri güç ve devir tabloları / Power and ratio table for hoisting applications / Tableau de classification des couples et rapports de réduction pour les applications de levage



D _T Tambur Çapı Drum Diameter <i>Diamètre de l'arbre</i> [mm]	V _h Kaldırma Hızı Lifting Speeds <i>Vitesse de levage</i> [m/min]	Vinç Sınıfı Crane Class <i>Classification de l'application de levage</i> ISO (FEM)	P ₁ Motor Gücü Power <i>Puissance</i> [kW]	n ₂ Çıkış Devri Output Speeds <i>Vitesse de sortie</i> [r.p.m]	i Tahvil Ratio <i>Rapport de réduction</i>	M ₂ Çıkış Momenti Output Torque <i>Couple de sortie</i>	Tip Type <i>Typ</i>		 kg
Ø110	2,1	M8 (5m)	0,75	12	120,792	591	IRCM 73 / 80 M 4b		
	2,2	M8 (5m)	0,75	13	107,423	525	IRCM 73 / 80 M 4b		
	2,6	M8 (5m)	0,75	15	96,194	470	IRCM 73 / 80 M 4b		
	2,8	M8 (5m)	1,1	16	86,628	621	IRCM 73 / 90 S 4a		
	3,3	M8 (5m)	1,1	19	73,889	530	IRCM 73 / 90 S 4a		
	3,6	M8 (5m)	1,1	21	65,252	468	IRCM 73 / 90 S 4a		
	4,1	M8 (5m)	1,5	24	57,996	567	IRCM 73 / 90 L 4a		
	4,7	M8 (5m)	1,5	27	51,846	507	IRCM 73 / 90 L 4a		
	5,7	M8 (5m)	2,2	33	41,848	600	IRCM 73 / 100 L 4a		
	6,7	M8 (5m)	2,2	39	35,564	510	IRCM 73 / 100 L 4a		
	7,6	M8 (5m)	2,2	44	32,098	461	IRCM 73 / 100 L 4a		
	9,2	M8 (5m)	3	53	26,291	514	IRCM 73 / 100 L 4b		
10	M8 (5m)	3	59	23,834	466	IRCM 73 / 100 L 4b			
Ø120	2,3	M8 (5m)	0,75	12	120,792	591	IRCM 73 / 80 M 4b		
	2,4	M8 (5m)	0,75	13	107,423	525	IRCM 73 / 80 M 4b		
	2,8	M8 (5m)	1,1	15	96,194	690	IRCM 73 / 90 S 4a		
	3,0	M8 (5m)	1,1	16	86,628	621	IRCM 73 / 90 S 4a		
	3,6	M8 (5m)	1,1	19	73,889	530	IRCM 73 / 90 S 4a		
	4,0	M8 (5m)	1,1	21	65,252	468	IRCM 73 / 90 S 4a		
	4,5	M8 (5m)	1,5	24	57,996	567	IRCM 73 / 90 L 4a		
	5,1	M8 (5m)	1,5	27	51,846	507	IRCM 73 / 90 L 4a		
	6,2	M8 (5m)	2,2	33	41,848	600	IRCM 73 / 100 L 4a		
	7,3	M8 (5m)	2,2	39	35,564	510	IRCM 73 / 100 L 4a		
	8,3	M8 (5m)	3	44	32,098	628	IRCM 73 / 100 L 4b		
	10	M8 (5m)	3	53	26,291	514	IRCM 73 / 100 L 4b		
11	M8 (5m)	4	59	23,834	622	IRCM 73 / 112 M 4b			
Ø130	2,0	M8 (5m)	0,75	10	133,509	653	IRCM 83 / 80 M 4b		
	2,4	M8 (5m)	0,75	12	121,711	595	IRCM 83 / 80 M 4b		
	2,9	M8 (5m)	1,1	14	102,407	735	IRCM 83 / 90 S 4a		
	3,1	M8 (5m)	1,1	15	92,330	662	IRCM 83 / 90 S 4a		
	3,9	M8 (5m)	1,1	19	75,613	542	IRCM 83 / 90 S 4a		
	4,7	M8 (5m)	1,5	23	60,299	590	IRCM 83 / 90 L 4a		
	5,3	M8 (5m)	1,5	26	54,358	532	IRCM 83 / 90 L 4a		
	5,9	M8 (5m)	2,2	29	48,314	693	IRCM 83 / 100 L 4a		
	7,1	M8 (5m)	2,2	35	39,796	571	IRCM 83 / 100 L 4a		
	8,6	M8 (5m)	3	42	33,003	646	IRCM 83 / 100 L 4b		
	10	M8 (5m)	3	51	27,535	539	IRCM 83 / 100 L 4b		
	2,4	M8 (5m)	0,75	12	120,792	591	IRCM 73 / 80 M 4b		
	2,7	M8 (5m)	0,75	13	107,423	525	IRCM 73 / 80 M 4b		
	3,1	M8 (5m)	1,1	15	96,194	690	IRCM 73 / 90 S 4a		
	3,3	M8 (5m)	1,1	16	86,628	621	IRCM 73 / 90 S 4a		
	3,9	M8 (5m)	1,1	19	73,889	530	IRCM 73 / 90 S 4a		
	4,3	M8 (5m)	1,5	21	65,252	638	IRCM 73 / 90 L 4a		
	4,9	M8 (5m)	1,5	24	57,996	567	IRCM 73 / 90 L 4a		
	5,5	M8 (5m)	2,2	27	51,846	744	IRCM 73 / 100 L 4a		
	6,7	M8 (5m)	2,2	33	41,848	600	IRCM 73 / 100 L 4a		
	8,0	M8 (5m)	2,2	39	35,564	510	IRCM 73 / 100 L 4a		
	9,0	M7 (4m)	3	44	32,098	628	IRCM 73 / 100 L 4b		
	11	M7 (4m)	3	53	26,291	514	IRCM 73 / 100 L 4b		
	12	M7 (4m)	4	59	23,834	622	IRCM 73 / 112 M 4b		





D _T Tambur Çapı Drum Diameter <i>Diamètre de l'arbre</i> [mm]	V _h Kaldırma Hızı Lifting Speeds <i>Vitesse de levage</i> [m/min]	Vinç Sınıfı Crane Class <i>Classification de l'application de levage</i> ISO (FEM)	P ₁ Motor Gücü Power <i>Puissance</i> [kW]	n ₂ Çıkış Devri Output Speeds <i>Vitesse de sortie</i> [r.p.m]	i Tahvil Ratio <i>Rapport de réduction</i>	M ₂ Çıkış Momenti Output Torque <i>Couple de sortie</i>	Tip Type <i>Typ</i>		 kg
Ø140	2,2	M8 (5m)	0,75	10	133,509	653	IRCM 83 / 80 M 4b		
	2,6	M8 (5m)	0,75	12	121,711	595	IRCM 83 / 80 M 4b		
	3,1	M8 (5m)	1,1	14	102,407	735	IRCM 83 / 90 S 4a		
	3,3	M8 (5m)	1,1	15	92,330	662	IRCM 83 / 90 S 4a		
	4,2	M8 (5m)	1,5	19	75,613	740	IRCM 83 / 90 L 4a		
	5,1	M8 (5m)	1,5	23	60,299	590	IRCM 83 / 90 L 4a		
	5,7	M8 (5m)	2,2	26	54,358	780	IRCM 83 / 100 L 4a		
	6,4	M8 (5m)	2,2	29	48,314	693	IRCM 83 / 100 L 4a		
	7,7	M8 (5m)	2,2	35	39,796	571	IRCM 83 / 100 L 4a		
	9,2	M8 (5m)	3	42	33,003	646	IRCM 83 / 100 L 4b		
	11	M8 (5m)	4	51	27,535	718	IRCM 83 / 112 M 4b		
	2,6	M8 (5m)	0,75	12	120,792	591	IRCM 73 / 80 M 4b		
	2,9	M8 (5m)	1,1	13	107,423	771	IRCM 73 / 90 S 4a		
	3,3	M7 (4m)	1,1	15	96,194	690	IRCM 73 / 90 S 4a		
	3,5	M7 (4m)	1,1	16	86,628	621	IRCM 73 / 90 S 4a		
	4,2	M7 (4m)	1,5	19	73,889	723	IRCM 73 / 90 L 4a		
	4,6	M7 (4m)	1,5	21	65,252	638	IRCM 73 / 90 L 4a		
	5,3	M7 (4m)	1,5	24	57,996	567	IRCM 73 / 90 L 4a		
	5,9	M7 (4m)	2,2	27	51,846	744	IRCM 73 / 100 L 4a		
	7,3	M7 (4m)	2,2	33	41,848	600	IRCM 73 / 100 L 4a		
8,6	M7 (4m)	3	39	35,564	696	IRCM 73 / 100 L 4b			
9,7	M7 (4m)	3	44	32,098	628	IRCM 73 / 100 L 4b			
12	M7 (4m)	4	53	26,291	686	IRCM 73 / 112 M 4b			
13	M7 (4m)	4	59	23,834	622	IRCM 73 / 112 M 4b			
Ø150	2,4	M8 (5m)	0,75	10	133,509	653	IRCM 83 / 80 M 4b		
	2,8	M8 (5m)	1,1	12	121,711	873	IRCM 83 / 90 S 4a		
	3,3	M8 (5m)	1,1	14	102,407	735	IRCM 83 / 90 S 4a		
	3,5	M8 (5m)	1,1	15	92,330	662	IRCM 83 / 90 S 4a		
	4,5	M8 (5m)	1,5	19	75,613	740	IRCM 83 / 90 L 4a		
	5,4	M8 (5m)	1,5	23	60,299	590	IRCM 83 / 90 L 4a		
	6,1	M8 (5m)	2,2	26	54,358	780	IRCM 83 / 100 L 4a		
	6,8	M8 (5m)	2,2	29	48,314	693	IRCM 83 / 100 L 4a		
	8,2	M8 (5m)	3	35	39,796	779	IRCM 83 / 100 L 4b		
	9,9	M8 (5m)	3	42	33,003	646	IRCM 83 / 100 L 4b		
	12	M8 (5m)	4	51	27,535	718	IRCM 83 / 112 M 4b		
	2,8	M7 (4m)	1,1	12	120,792	866	IRCM 73 / 90 S 4a		
	3,1	M7 (4m)	1,1	13	107,423	771	IRCM 73 / 90 S 4a		
	3,5	M7 (4m)	1,1	15	96,194	690	IRCM 73 / 90 S 4a		
	3,8	M7 (4m)	1,1	16	86,628	621	IRCM 73 / 90 S 4a		
	4,5	M7 (4m)	1,5	19	73,889	723	IRCM 73 / 90 L 4a		
	4,9	M7 (4m)	1,5	21	65,252	638	IRCM 73 / 90 L 4a		
	5,7	M7 (4m)	2,2	24	57,996	832	IRCM 73 / 100 L 4a		
	6,4	M7 (4m)	2,2	27	51,846	744	IRCM 73 / 100 L 4a		
	7,8	M7 (4m)	2,2	33	41,848	600	IRCM 73 / 100 L 4a		
9,2	M7 (4m)	3	39	35,564	696	IRCM 73 / 100 L 4b			
10	M7 (4m)	3	44	32,098	628	IRCM 73 / 100 L 4b			
12	M7 (4m)	4	53	26,291	686	IRCM 73 / 112 M 4b			
14	M7 (4m)	4	59	23,834	622	IRCM 73 / 112 M 4b			



Vinç sistemleri kaldırma redüktörleri güç ve devir tabloları / Power and ratio table for hoisting applications / Tableau de classification des couples et rapports de réduction pour les applications de levage



D _T Tambur Çapı Drum Diameter Diamètre de l'arbre [mm]	V _h Kaldırma Hızı Lifting Speeds Vitesse de levage [m/min]	Vinç Sınıfı Crane Class Classification de l'application de levage ISO (FEM)	P ₁ Motor Gücü Power Puissance [kW]	n ₂ Çıkış Devri Output Speeds Vitesse de sortie [r.p.m]	i Tahvil Ratio Rapport de réduction	M ₂ Çıkış Momenti Output Torque Couple de sortie	Tip Type Typ		 kg
Ø160	2,5	M8 (5m)	0,75	10	133,509	653	IRCM 83 / 80 M 4b		
	3,0	M8 (5m)	1,1	12	121,711	873	IRCM 83 / 90 S 4a		
	3,5	M8 (5m)	1,1	14	102,407	735	IRCM 83 / 90 S 4a		
	3,8	M8 (5m)	1,1	15	92,330	662	IRCM 83 / 90 S 4a		
	4,8	M8 (5m)	1,5	19	75,613	740	IRCM 83 / 90 L 4a		
	5,8	M8 (5m)	2,2	23	60,299	865	IRCM 83 / 100 L 4a		
	6,5	M8 (5m)	2,2	26	54,358	780	IRCM 83 / 100 L 4a		
	7,3	M8 (5m)	2,2	29	48,314	693	IRCM 83 / 100 L 4a		
	8,8	M8 (5m)	3	35	39,796	779	IRCM 83 / 100 L 4b		
	11	M8 (5m)	3	42	33,003	646	IRCM 83 / 100 L 4b		
	13	M8 (5m)	4	51	27,535	718	IRCM 83 / 112 M 4b		
	3,0	M7 (4m)	1,1	12	120,792	866	IRCM 73 / 90 S 4a		
	3,3	M7 (4m)	1,1	13	107,423	771	IRCM 73 / 90 S 4a		
	3,8	M7 (4m)	1,1	15	96,194	690	IRCM 73 / 90 S 4a		
	4,0	M7 (4m)	1,5	16	86,628	847	IRCM 73 / 90 L 4a		
	4,8	M7 (4m)	1,5	19	73,889	723	IRCM 73 / 90 L 4a		
	5,3	M7 (4m)	1,5	21	65,252	638	IRCM 73 / 90 L 4a		
	6,0	M7 (4m)	2,2	24	57,996	832	IRCM 73 / 100 L 4a		
	6,8	M7 (4m)	2,2	27	51,846	744	IRCM 73 / 100 L 4a		
	8,3	M7 (4m)	3	33	41,848	819	IRCM 73 / 100 L 4b		
9,8	M7 (4m)	3	39	35,564	696	IRCM 73 / 100 L 4b			
11	M7 (4m)	4	44	32,098	837	IRCM 73 / 112 M 4b			
13	M6 (3m)	4	53	26,291	686	IRCM 73 / 112 M 4b			
15	M6 (3m)	5,5	59	23,834	855	IRCM 73 / 132 S 4c			
Ø170	2,7	M8 (5m)	0,75	10	133,509	653	IRCM 83 / 80 M 4b		
	3,2	M8 (5m)	1,1	12	121,711	873	IRCM 83 / 90 S 4a		
	3,7	M8 (5m)	1,1	14	102,407	735	IRCM 83 / 90 S 4a		
	4,0	M8 (5m)	1,5	15	92,330	903	IRCM 83 / 90 L 4a		
	5,1	M8 (5m)	1,5	19	75,613	740	IRCM 83 / 90 L 4a		
	6,1	M8 (5m)	2,2	23	60,299	865	IRCM 83 / 100 L 4a		
	6,9	M8 (5m)	2,2	26	54,358	780	IRCM 83 / 100 L 4a		
	7,7	M8 (5m)	2,2	29	48,314	693	IRCM 83 / 100 L 4a		
	9,3	M8 (5m)	3	35	39,796	779	IRCM 83 / 100 L 4b		
	11	M8 (5m)	4	42	33,003	861	IRCM 83 / 112 M 4b		
	14	M8 (5m)	4	51	27,535	718	IRCM 83 / 112 M 4b		
	3,2	M7 (4m)	1,1	12	120,792	866	IRCM 73 / 90 S 4a		
	3,5	M7 (4m)	1,1	13	107,423	771	IRCM 73 / 90 S 4a		
	4,0	M7 (4m)	1,5	15	96,194	941	IRCM 73 / 90 L 4a		
	4,3	M7 (4m)	1,5	16	86,628	847	IRCM 73 / 90 L 4a		
	5,1	M7 (4m)	1,5	19	73,889	723	IRCM 73 / 90 L 4a		
	5,6	M7 (4m)	2,2	21	65,252	936	IRCM 73 / 100 L 4a		
	6,4	M7 (4m)	2,2	24	57,996	832	IRCM 73 / 100 L 4a		
	7,2	M7 (4m)	2,2	27	51,846	744	IRCM 73 / 100 L 4a		
	8,8	M7 (4m)	3	33	41,848	819	IRCM 73 / 100 L 4b		
10	M6 (3m)	3	39	35,564	696	IRCM 73 / 100 L 4b			
12	M6 (3m)	4	44	32,098	837	IRCM 73 / 112 M 4b			
14	M6 (3m)	4	53	26,291	686	IRCM 73 / 112 M 4b			
16	M6 (3m)	5,5	59	23,834	855	IRCM 73 / 132 S 4c			



D _T Tambur Çapı Drum Diameter <i>Diamètre de l'arbre</i> [mm]	V _h Kaldırma Hızı Lifting Speeds <i>Vitesse de levage</i> [m/min]	Vinç Sınıfı Crane Class <i>Classification de l'application de levage</i> ISO (FEM)	P ₁ Motor Gücü Power <i>Puissance</i> [kW]	n ₂ Çıkış Devri Output Speeds <i>Vitesse de sortie</i> [r.p.m]	i Tahvil Ratio <i>Rapport de réduction</i>	M ₂ Çıkış Momenti Output Torque <i>Couple de sortie</i>	Tip Type <i>Typ</i>		 kg
Ø180	2,8	M8 (5m)	1,1	10	133,509	958	IRCM 83 / 90 S 4a		
	3,4	M8 (5m)	1,1	12	121,711	873	IRCM 83 / 90 S 4a		
	4,0	M8 (5m)	1,1	14	102,407	735	IRCM 83 / 90 S 4a		
	4,2	M8 (5m)	1,5	15	92,330	903	IRCM 83 / 90 L 4a		
	5,4	M8 (5m)	1,5	19	75,613	740	IRCM 83 / 90 L 4a		
	6,5	M8 (5m)	2,2	23	60,299	865	IRCM 83 / 100 L 4a		
	7,3	M8 (5m)	2,2	26	54,358	780	IRCM 83 / 100 L 4a		
	8,2	M8 (5m)	3	29	48,314	945	IRCM 83 / 100 L 4b		
	9,9	M8 (5m)	3	35	39,796	779	IRCM 83 / 100 L 4b		
	12	M8 (5m)	4	42	33,003	861	IRCM 83 / 112 M 4b		
	14	M8 (5m)	4	51	27,535	718	IRCM 83 / 112 M 4b		
	3,4	M7 (4m)	1,1	12	120,792	866	IRCM 73 / 90 S 4a		
	3,7	M7 (4m)	1,1	13	107,423	771	IRCM 73 / 90 S 4a		
	4,2	M6 (3m)	1,5	15	96,194	941	IRCM 73 / 90 L 4a		
	4,5	M6 (3m)	1,5	16	86,628	847	IRCM 73 / 90 L 4a		
	5,4	M6 (3m)	1,5	19	73,889	723	IRCM 73 / 90 L 4a		
	5,9	M6 (3m)	2,2	21	65,252	936	IRCM 73 / 100 L 4a		
	6,8	M6 (3m)	2,2	24	57,996	832	IRCM 73 / 100 L 4a		
	7,6	M6 (3m)	2,2	27	51,846	744	IRCM 73 / 100 L 4a		
	9,3	M6 (3m)	3	33	41,848	819	IRCM 73 / 100 L 4b		
11	M6 (3m)	4	39	35,564	928	IRCM 73 / 112 M 4b			
12	M6 (3m)	4	44	32,098	837	IRCM 73 / 112 M 4b			
15	M6 (3m)	5,5	53	26,291	943	IRCM 73 / 132 S 4c			
Ø190	3,0	M8 (5m)	1,1	10	133,509	958	IRCM 83 / 90 S 4a		
	3,6	M8 (5m)	1,1	12	121,711	873	IRCM 83 / 90 S 4a		
	4,2	M8 (5m)	1,5	14	102,407	1002	IRCM 83 / 90 L 4a		
	4,5	M8 (5m)	1,5	15	92,330	903	IRCM 83 / 90 L 4a		
	5,7	M8 (5m)	2,2	19	75,613	1085	IRCM 83 / 100 L 4a		
	6,9	M8 (5m)	2,2	23	60,299	865	IRCM 83 / 100 L 4a		
	7,8	M8 (5m)	2,2	26	54,358	780	IRCM 83 / 100 L 4a		
	8,7	M8 (5m)	3	29	48,314	945	IRCM 83 / 100 L 4b		
	10	M8 (5m)	3	35	39,796	779	IRCM 83 / 100 L 4b		
	13	M8 (5m)	4	42	33,003	861	IRCM 83 / 112 M 4b		
	15	M8 (5m)	5,5	51	27,535	988	IRCM 83 / 132 S 4c		
Ø200	3,1	M8 (5m)	1,1	10	133,509	958	IRCM 83 / 90 S 4a		
	3,8	M8 (5m)	1,1	12	121,711	873	IRCM 83 / 90 S 4a		
	4,4	M8 (5m)	1,5	14	102,407	1002	IRCM 83 / 90 L 4a		
	4,7	M8 (5m)	1,5	15	92,330	903	IRCM 83 / 90 L 4a		
	6,0	M8 (5m)	2,2	19	75,613	1085	IRCM 83 / 100 L 4a		
	7,2	M8 (5m)	2,2	23	60,299	865	IRCM 83 / 100 L 4a		
	8,2	M8 (5m)	3	26	54,358	1063	IRCM 83 / 100 L 4b		
	9,1	M8 (5m)	3	29	48,314	945	IRCM 83 / 100 L 4b		
	11	M8 (5m)	4	35	39,796	1038	IRCM 83 / 112 M 4b		
	13	M8 (5m)	4	42	33,003	861	IRCM 83 / 112 M 4b		
16	M8 (5m)	5,5	51	27,535	988	IRCM 83 / 132 S 4c			



Vinç sistemleri kaldırma redüktörleri güç ve devir tabloları / Power and ratio table for hoisting applications / Tableau de classification des couples et rapports de réduction pour les applications de levage



D _T Tambur Çapı Drum Diameter Diamètre de l'arbre [mm]	V _h Kaldırma Hızı Lifting Speeds Vitesse de levage [m/min]	Vinç Sınıfı Crane Class Classification de l'application de levage ISO (FEM)	P ₁ Motor Gücü Power Puissance [kW]	n ₂ Çıkış Devri Output Speeds Vitesse de sortie [r.p.m]	i Tahvil Ratio Rapport de réduction	M ₂ Çıkış Momenti Output Torque Couple de sortie	Tip Type Typ		 kg
Ø230	5,1	M8 (5m)	2,2	7,0	199,476	2862	IRCM 103 / 100 L 4a		
	5,7	M8 (5m)	2,2	7,9	177,284	2543	IRCM 103 / 100 L 4a		
	7,1	M8 (5m)	3	10	143,552	2808	IRCM 103 / 100 L 4b		
	8,7	M8 (5m)	3	12	119,126	2331	IRCM 103 / 100 L 4b		
	9	M8 (5m)	4	13	109,276	2850	IRCM 103 / 112 M 4b		
	11	M8 (5m)	4	15	95,896	2501	IRCM 103 / 112 M 4b		
	13	M8 (5m)	5,5	18	78,692	2822	IRCM 103 / 132 S 4c		
	14	M8 (5m)	5,5	19	71,869	2578	IRCM 103 / 132 S 4c		
	17	M8 (5m)	7,5	24	58,778	2875	IRCM 103 / 132 M 4b		
	19	M8 (5m)	7,5	27	51,907	2539	IRCM 103 / 132 M 4b		
	6,2	M8 (5m)	2,2	8,6	162,826	2336	IRCM 93 / 100 L 4a		
	6,9	M8 (5m)	3	9,5	146,946	2875	IRCM 93 / 100 L 4b		
	7,2	M8 (5m)	3	10	133,419	2610	IRCM 93 / 100 L 4b		
	9,4	M8 (5m)	4	13	111,602	2911	IRCM 93 / 112 M 4b		
	12	M8 (5m)	4	16	87,936	2294	IRCM 93 / 112 M 4b		
	13	M8 (5m)	5,5	18	79,841	2864	IRCM 93 / 132 S 4c		
	15	M7 (4m)	5,5	21	66,785	2395	IRCM 93 / 132 S 4c		
	17	M7 (4m)	7,5	23	61,444	3005	IRCM 93 / 132 M 4b		
	19	M7 (4m)	7,5	26	54,545	2668	IRCM 93 / 132 M 4b		
	22	M7 (4m)	9,2	31	44,753	2685	IRCM 93 / 132 M 4c		
27	M7 (4m)	11	38	37,199	2668	IRCM 93 / 160 M 4b			
30	M7 (4m)	11	41	34,034	2441	IRCM 93 / 160 M 4b			
32	M7 (4m)	15	45	31,194	3051	IRCM 93 / 160 L 4a			
Ø240	5,3	M8 (5m)	2,2	7,0	199,476	2862	IRCM 103 / 100 L 4a		
	6,0	M8 (5m)	2,2	7,9	177,284	2543	IRCM 103 / 100 L 4a		
	7,4	M8 (5m)	3	10	143,552	2808	IRCM 103 / 100 L 4b		
	9,0	M8 (5m)	4	12	119,126	3107	IRCM 103 / 112 M 4b		
	9,8	M8 (5m)	4	13	109,276	2850	IRCM 103 / 112 M 4b		
	11,3	M8 (5m)	4	15	95,896	2501	IRCM 103 / 112 M 4b		
	13,6	M8 (5m)	5,5	18	78,692	2822	IRCM 103 / 132 S 4c		
	14,3	M8 (5m)	5,5	19	71,869	2578	IRCM 103 / 132 S 4c		
	18,1	M8 (5m)	7,5	24	58,778	2875	IRCM 103 / 132 M 4b		
	20,3	M8 (5m)	7,5	27	51,907	2539	IRCM 103 / 132 M 4b		
	6,5	M8 (5m)	3	8,6	162,826	3186	IRCM 93 / 100 L 4b		
	7,2	M8 (5m)	3	9,5	146,946	2875	IRCM 93 / 100 L 4b		
	7,5	M8 (5m)	3	10	133,419	2610	IRCM 93 / 100 L 4b		
	9,8	M8 (5m)	4	13	111,602	2911	IRCM 93 / 112 M 4b		
	12	M8 (5m)	5,5	16	87,936	3154	IRCM 93 / 132 S 4c		
	14	M7 (4m)	5,5	18	79,841	2864	IRCM 93 / 132 S 4c		
	16	M7 (4m)	5,5	21	66,785	2395	IRCM 93 / 132 S 4c		
	17	M7 (4m)	7,5	23	61,444	3005	IRCM 93 / 132 M 4b		
	20	M7 (4m)	7,5	26	54,545	2668	IRCM 93 / 132 M 4b		
	23	M7 (4m)	9,2	31	44,753	2685	IRCM 93 / 132 M 4c		
29	M7 (4m)	11	38	37,199	2668	IRCM 93 / 160 M 4b			
31	M7 (4m)	11	41	34,034	2441	IRCM 93 / 160 M 4b			
34	M7 (4m)	15	45	31,194	3051	IRCM 93 / 160 L 4a			
	5,5	M8 (5m)	2,2	7,0	199,476	2862	IRCM 103 / 100 L 4a		
	6,2	M8 (5m)	2,2	7,9	177,284	2543	IRCM 103 / 100 L 4a		
	7,7	M8 (5m)	3	10	143,552	2808	IRCM 103 / 100 L 4b		
	9,4	M8 (5m)	4	12	119,126	3107	IRCM 103 / 112 M 4b		
	10,2	M8 (5m)	4	13	109,276	2850	IRCM 103 / 112 M 4b		
	11,8	M8 (5m)	5,5	15	95,896	3440	IRCM 103 / 132 S 4c		
	14,1	M8 (5m)	5,5	18	78,692	2822	IRCM 103 / 132 S 4c		
	14,9	M8 (5m)	5,5	19	71,869	2578	IRCM 103 / 132 S 4c		
	18,8	M8 (5m)	7,5	24	58,778	2875	IRCM 103 / 132 M 4b		
	21,2	M8 (5m)	7,5	27	51,907	2539	IRCM 103 / 132 M 4b		



D _T Tambur Çapı Drum Diameter <i>Diamètre de l'arbre</i> [mm]	V _h Kaldırma Hızı Lifting Speeds <i>Vitesse de levage</i> [m/min]	Vinç Sınıfı Crane Class <i>Classification de l'application de levage</i> ISO (FEM)	P ₁ Motor Gücü Power <i>Puissance</i> [kW]	n ₂ Çıkış Devri Output Speeds <i>Vitesse de sortie</i> [r.p.m]	i Tahvil Ratio <i>Rapport de réduction</i>	M ₂ Çıkış Momenti Output Torque <i>Couple de sortie</i>	Tip Type <i>Typ</i>		 kg
Ø250	6,8	M8 (5m)	3	8,6	162,826	3186	IRCM 93 / 100 L 4b		
	7,5	M8 (5m)	3	9,5	146,946	2875	IRCM 93 / 100 L 4b		
	7,9	M8 (5m)	3	10	133,419	2610	IRCM 93 / 100 L 4b		
	10	M8 (5m)	4	13	111,602	2911	IRCM 93 / 112 M 4b		
	13	M7 (4m)	5,5	16	87,936	3154	IRCM 93 / 132 S 4c		
	14	M7 (4m)	5,5	18	79,841	2864	IRCM 93 / 132 S 4c		
	16	M7 (4m)	7,5	21	66,785	3266	IRCM 93 / 132 M 4b		
	18	M7 (4m)	7,5	23	61,444	3005	IRCM 93 / 132 M 4b		
	20	M7 (4m)	7,5	26	54,545	2668	IRCM 93 / 132 M 4b		
	24	M7 (4m)	9,2	31	44,753	2685	IRCM 93 / 132 M 4c		
	30	M7 (4m)	11	38	37,199	2668	IRCM 93 / 160 M 4b		
	32	M7 (4m)	15	41	34,034	3329	IRCM 93 / 160 L 4a		
	35	M7 (4m)	15	45	31,194	3051	IRCM 93 / 160 L 4a		
Ø260	5,7	M8 (5m)	2,2	7,0	199,476	2862	IRCM 103 / 100 L 4a		
	6,4	M8 (5m)	3	7,9	177,284	3468	IRCM 103 / 100 L 4b		
	8,0	M8 (5m)	3	10	143,552	2808	IRCM 103 / 100 L 4b		
	9,8	M8 (5m)	4	12	119,126	3107	IRCM 103 / 112 M 4b		
	10,6	M8 (5m)	4	13	109,276	2850	IRCM 103 / 112 M 4b		
	12,2	M8 (5m)	5,5	15	95,896	3440	IRCM 103 / 132 S 4c		
	14,7	M8 (5m)	5,5	18	78,692	2822	IRCM 103 / 132 S 4c		
	15,5	M8 (5m)	5,5	19	71,869	2578	IRCM 103 / 132 S 4c		
	19,6	M8 (5m)	7,5	24	58,778	2875	IRCM 103 / 132 M 4b		
	22,0	M8 (5m)	9,2	27	51,907	3114	IRCM 103 / 132 M 4c		
	7,0	M8 (5m)	3	8,6	162,826	3186	IRCM 93 / 100 L 4b		
	7,8	M8 (5m)	3	9,5	146,946	2875	IRCM 93 / 100 L 4b		
	8,2	M8 (5m)	3	10	133,419	2610	IRCM 93 / 100 L 4b		
	11	M7 (4m)	4	13	111,602	2911	IRCM 93 / 112 M 4b		
	13	M7 (4m)	5,5	16	87,936	3154	IRCM 93 / 132 S 4c		
	15	M7 (4m)	5,5	18	79,841	2864	IRCM 93 / 132 S 4c		
	17	M7 (4m)	7,5	21	66,785	3266	IRCM 93 / 132 M 4b		
	19	M7 (4m)	7,5	23	61,444	3005	IRCM 93 / 132 M 4b		
	21	M7 (4m)	7,5	26	54,545	2668	IRCM 93 / 132 M 4b		
	25	M7 (4m)	9,2	31	44,753	2685	IRCM 93 / 132 M 4c		
31	M7 (4m)	11	38	37,199	2668	IRCM 93 / 160 M 4b			
33	M7 (4m)	15	41	34,034	3329	IRCM 93 / 160 L 4a			
37	M7 (4m)	15	45	31,194	3051	IRCM 93 / 160 L 4a			
	5,9	M8 (5m)	2,2	7,0	199,476	2862	IRCM 103 / 100 L 4a		
	6,7	M8 (5m)	3	7,9	177,284	3468	IRCM 103 / 100 L 4b		
	8,3	M8 (5m)	3	10	143,552	2808	IRCM 103 / 100 L 4b		
	10,2	M8 (5m)	4	12	119,126	3107	IRCM 103 / 112 M 4b		
	11,0	M8 (5m)	4	13	109,276	2850	IRCM 103 / 112 M 4b		
	12,7	M8 (5m)	5,5	15	95,896	3440	IRCM 103 / 132 S 4c		
	15,3	M8 (5m)	5,5	18	78,692	2822	IRCM 103 / 132 S 4c		
	16,1	M8 (5m)	7,5	19	71,869	3515	IRCM 103 / 132 M 4b		
	20,3	M8 (5m)	7,5	24	58,778	2875	IRCM 103 / 132 M 4b		
	22,9	M8 (5m)	9,2	27	51,907	3114	IRCM 103 / 132 M 4c		



Vinç sistemleri kaldırma redükörleri güç ve devir tabloları / Power and ratio table for hoisting applications / Tableau de classification des couples et rapports de réduction pour les applications de levage



D _T Tambur Çapı Drum Diameter <i>Diamètre de l'arbre</i> [mm]	V _h Kaldırma Hızı Lifting Speeds <i>Vitesse de levage</i> [m/min]	Vinç Sınıfı Crane Class <i>Classification de l'application de levage</i> ISO (FEM)	P ₁ Motor Gücü Power <i>Puissance</i> [kW]	n ₂ Çıkış Devri Output Speeds <i>Vitesse de sortie</i> [r.p.m]	i Tahvil Ratio <i>Rapport de réduction</i>	M ₂ Çıkış Momenti Output Torque <i>Couple de sortie</i>	Tip Type <i>Typ</i>		 kg
Ø270	7,3	M8 (5m)	3	8,6	162,826	3186	IRCM 93 / 100 L 4b		
	8,1	M8 (5m)	3	9,5	146,946	2875	IRCM 93 / 100 L 4b		
	8,5	M8 (5m)	3	10	133,419	2610	IRCM 93 / 100 L 4b		
	11	M7 (4m)	4	13	111,602	2911	IRCM 93 / 112 M 4b		
	14	M7 (4m)	5,5	16	87,936	3154	IRCM 93 / 132 S 4c		
	15	M7 (4m)	5,5	18	79,841	2864	IRCM 93 / 132 S 4c		
	18	M7 (4m)	7,5	21	66,785	3266	IRCM 93 / 132 M 4b		
	19	M7 (4m)	7,5	23	61,444	3005	IRCM 93 / 132 M 4b		
	22	M7 (4m)	9,2	26	54,545	3272	IRCM 93 / 132 M 4c		
	26	M6 (3m)	9,2	31	44,753	2685	IRCM 93 / 132 M 4c		
	32	M6 (3m)	15	38	37,199	3639	IRCM 93 / 160 L 4a		
	35	M6 (3m)	15	41	34,034	3329	IRCM 93 / 160 L 4a		
	38	M6 (3m)	15	45	31,194	3051	IRCM 93 / 160 L 4a		
Ø280	6,2	M8 (5m)	2,2	7,0	199,476	2862	IRCM 103 / 100 L 4a		
	6,9	M8 (5m)	3	7,9	177,284	3468	IRCM 103 / 100 L 4b		
	8,6	M8 (5m)	3	10	143,552	2808	IRCM 103 / 100 L 4b		
	10,6	M8 (5m)	4	12	119,126	3107	IRCM 103 / 112 M 4b		
	11,4	M8 (5m)	4	13	109,276	2850	IRCM 103 / 112 M 4b		
	13,2	M8 (5m)	5,5	15	95,896	3440	IRCM 103 / 132 S 4c		
	15,8	M8 (5m)	5,5	18	78,692	2822	IRCM 103 / 132 S 4c		
	16,7	M8 (5m)	7,5	19	71,869	3515	IRCM 103 / 132 M 4b		
	21,1	M8 (5m)	7,5	24	58,778	2875	IRCM 103 / 132 M 4b		
	23,7	M8 (5m)	9,2	27	51,907	3114	IRCM 103 / 132 M 4c		
	7,6	M8 (5m)	3	8,6	162,826	3186	IRCM 93 / 100 L 4b		
	8,4	M8 (5m)	3	9,5	146,946	2875	IRCM 93 / 100 L 4b		
	8,8	M7 (4m)	4	10	133,419	3480	IRCM 93 / 112 M 4b		
	11	M7 (4m)	4	13	111,602	2911	IRCM 93 / 112 M 4b		
	14	M7 (4m)	5,5	16	87,936	3154	IRCM 93 / 132 S 4c		
	16	M7 (4m)	5,5	18	79,841	2864	IRCM 93 / 132 S 4c		
	18	M7 (4m)	7,5	21	66,785	3266	IRCM 93 / 132 M 4b		
	20	M7 (4m)	7,5	23	61,444	3005	IRCM 93 / 132 M 4b		
	23	M6 (3m)	9,2	26	54,545	3272	IRCM 93 / 132 M 4c		
	27	M6 (3m)	11	31	44,753	3210	IRCM 93 / 160 M 4b		
33	M6 (3m)	15	38	37,199	3639	IRCM 93 / 160 L 4a			
36	M6 (3m)	15	41	34,034	3329	IRCM 93 / 160 L 4a			
40	M6 (3m)	15	45	31,194	3051	IRCM 93 / 160 L 4a			
6,4	M8 (5m)	2,2	7,0	199,476	2862	IRCM 103 / 100 L 4a			
7,2	M8 (5m)	3	7,9	177,284	3468	IRCM 103 / 100 L 4b			
8,9	M8 (5m)	4	10	143,552	3745	IRCM 103 / 112 M 4b			
10,9	M8 (5m)	4	12	119,126	3107	IRCM 103 / 112 M 4b			
11,8	M8 (5m)	5,5	13	109,276	3919	IRCM 103 / 132 S 4c			
13,7	M8 (5m)	5,5	15	95,896	3440	IRCM 103 / 132 S 4c			
16,4	M8 (5m)	7,5	18	78,692	3849	IRCM 103 / 132 M 4b			
17,3	M8 (5m)	7,5	19	71,869	3515	IRCM 103 / 132 M 4b			
21,9	M8 (5m)	9,2	24	58,778	3526	IRCM 103 / 132 M 4c			
24,6	M8 (5m)	9,2	27	51,907	3114	IRCM 103 / 132 M 4c			





D _T Tambur Çapı Drum Diameter <i>Diamètre de l'arbre</i> [mm]	V _h Kaldırma Hızı Lifting Speeds <i>Vitesse de levage</i> [m/min]	Vinç Sınıfı Crane Class <i>Classification de l'application de levage</i> ISO (FEM)	P ₁ Motor Gücü Power <i>Puissance</i> [kW]	n ₂ Çıkış Devri Output Speeds <i>Vitesse de sortie</i> [r.p.m]	i Tahvil Ratio <i>Rapport de réduction</i>	M ₂ Çıkış Momenti Output Torque <i>Couple de sortie</i>	Tip Type <i>Typ</i>		 kg
Ø290	7,8	M7 (4m)	3	8,6	162,826	3186	IRCM 93 / 100 L 4b		
	8,7	M7 (4m)	3	9,5	146,946	2875	IRCM 93 / 100 L 4b		
	9,1	M7 (4m)	4	10	133,419	3480	IRCM 93 / 112 M 4b		
	12	M7 (4m)	5,5	13	111,602	4003	IRCM 93 / 132 S 4c		
	15	M7 (4m)	5,5	16	87,936	3154	IRCM 93 / 132 S 4c		
	16	M7 (4m)	7,5	18	79,841	3905	IRCM 93 / 132 M 4b		
	19	M6 (3m)	7,5	21	66,785	3266	IRCM 93 / 132 M 4b		
	21	M6 (3m)	7,5	23	61,444	3005	IRCM 93 / 132 M 4b		
	24	M6 (3m)	9,2	26	54,545	3272	IRCM 93 / 132 M 4c		
	28	M6 (3m)	11	31	44,753	3210	IRCM 93 / 160 M 4b		
	35	M6 (3m)	15	38	37,199	3639	IRCM 93 / 160 L 4a		
	37	M6 (3m)	15	41	34,034	3329	IRCM 93 / 160 L 4a		
41	M6 (3m)	15	45	31,194	3051	IRCM 93 / 160 L 4a			
Ø300	6,6	M8 (5m)	3	7,0	199,476	3903	IRCM 103 / 100 L 4b		
	7,4	M8 (5m)	3	7,9	177,284	3468	IRCM 103 / 100 L 4b		
	9,2	M8 (5m)	4	10	143,552	3745	IRCM 103 / 112 M 4b		
	11,3	M8 (5m)	4	12	119,126	3107	IRCM 103 / 112 M 4b		
	12,2	M8 (5m)	5,5	13	109,276	3919	IRCM 103 / 132 S 4c		
	14,1	M8 (5m)	5,5	15	95,896	3440	IRCM 103 / 132 S 4c		
	17,0	M8 (5m)	7,5	18	78,692	3849	IRCM 103 / 132 M 4b		
	17,9	M8 (5m)	7,5	19	71,869	3515	IRCM 103 / 132 M 4b		
	22,6	M8 (5m)	9,2	24	58,778	3526	IRCM 103 / 132 M 4c		
	25,4	M8 (5m)	9,2	27	51,907	3114	IRCM 103 / 132 M 4c		
	8,1	M7 (4m)	3	8,6	162,826	3186	IRCM 93 / 100 L 4b		
	8,9	M7 (4m)	4	9,5	146,946	3833	IRCM 93 / 112 M 4b		
	9,4	M7 (4m)	4	10	133,419	3480	IRCM 93 / 112 M 4b		
	12	M7 (4m)	5,5	13	111,602	4003	IRCM 93 / 132 S 4c		
	15	M7 (4m)	5,5	16	87,936	3154	IRCM 93 / 132 S 4c		
	17	M6 (3m)	7,5	18	79,841	3905	IRCM 93 / 132 M 4b		
	20	M6 (3m)	7,5	21	66,785	3266	IRCM 93 / 132 M 4b		
	22	M6 (3m)	7,5	23	61,444	3005	IRCM 93 / 132 M 4b		
	24	M6 (3m)	9,2	26	54,545	3272	IRCM 93 / 132 M 4c		
	29	M6 (3m)	11	31	44,753	3210	IRCM 93 / 160 M 4b		
36	M6 (3m)	15	38	37,199	3639	IRCM 93 / 160 L 4a			
39	M6 (3m)	15	41	34,034	3329	IRCM 93 / 160 L 4a			
42	M6 (3m)	15	45	31,194	3051	IRCM 93 / 160 L 4a			



Vinç sistemleri kaldırma redüktörleri güç ve devir tabloları / Power and ratio table for hoisting applications / Tableau de classification des couples et rapports de réduction pour les applications de levage

D _T Tambur Çapı Drum Diameter Diamètre de l'arbre [mm]	V _h Kaldırma Hızı Lifting Speeds Vitesse de levage [m/min]	Vinç Sınıfı Crane Class Classification de l'application de levage ISO (FEM)	P ₁ Motor Gücü Power Puissance [kW]	n ₂ Çıkış Devri Output Speeds Vitesse de sortie [r.p.m]	i Tahvil Ratio Rapport de réduction	M ₂ Çıkış Momenti Output Torque Couple de sortie	Tip Type Typ		 kg
Ø170	2,3	M8 (5m)	1,1	8,6	162,826	1168	IRCM 93 / 90 S 4a		
	2,5	M8 (5m)	1,1	9,5	146,946	1054	IRCM 93 / 90 S 4a		
	2,7	M8 (5m)	1,1	10	133,419	957	IRCM 93 / 90 S 4a		
	3,5	M8 (5m)	1,5	13	111,602	1092	IRCM 93 / 90 L 4a		
	4,3	M8 (5m)	1,5	16	87,936	860	IRCM 93 / 90 L 4a		
	4,8	M8 (5m)	2,2	18	79,841	1145	IRCM 93 / 100 L 4a		
	5,6	M8 (5m)	2,2	21	66,785	958	IRCM 93 / 100 L 4a		
	6,1	M8 (5m)	2,2	23	61,444	882	IRCM 93 / 100 L 4a		
	6,9	M8 (5m)	3	26	54,545	1067	IRCM 93 / 100 L 4b		
	8,3	M8 (5m)	3	31	44,753	876	IRCM 93 / 100 L 4b		
	10	M8 (5m)	4	38	37,199	970	IRCM 93 / 112 M 4b		
	11	M8 (5m)	4	41	34,034	888	IRCM 93 / 112 M 4b		
	12	M8 (5m)	5,5	45	31,194	1119	IRCM 93 / 132 S 4c		
	2,7	M8 (5m)	1,1	10	133,509	958	IRCM 83 / 90 S 4a		
	3,2	M8 (5m)	1,5	12	121,711	1191	IRCM 83 / 90 L 4a		
	3,7	M8 (5m)	1,5	14	102,407	1002	IRCM 83 / 90 L 4a		
	4,0	M8 (5m)	1,5	15	92,330	903	IRCM 83 / 90 L 4a		
	5,1	M8 (5m)	2,2	19	75,613	1085	IRCM 83 / 100 L 4a		
	6,1	M8 (5m)	2,2	23	60,299	865	IRCM 83 / 100 L 4a		
	6,9	M8 (5m)	3	26	54,358	1063	IRCM 83 / 100 L 4b		
7,7	M8 (5m)	3	29	48,314	945	IRCM 83 / 100 L 4b			
9,3	M8 (5m)	4	35	39,796	1038	IRCM 83 / 112 M 4b			
11	M8 (5m)	4	42	33,003	861	IRCM 83 / 112 M 4b			
14	M8 (5m)	5,5	51	27,535	988	IRCM 83 / 132 S 4c			
Ø180	2,4	M8 (5m)	1,1	8,6	162,826	1168	IRCM 93 / 90 S 4a		
	2,7	M8 (5m)	1,1	9,5	146,946	1054	IRCM 93 / 90 S 4a		
	2,8	M8 (5m)	1,1	10	133,419	957	IRCM 93 / 90 S 4a		
	3,7	M8 (5m)	1,5	13	111,602	1092	IRCM 93 / 90 L 4a		
	4,5	M8 (5m)	2,2	16	87,936	1262	IRCM 93 / 100 L 4a		
	5,1	M8 (5m)	2,2	18	79,841	1145	IRCM 93 / 100 L 4a		
	5,9	M8 (5m)	2,2	21	66,785	958	IRCM 93 / 100 L 4a		
	6,5	M8 (5m)	3	23	61,444	1202	IRCM 93 / 100 L 4b		
	7,3	M8 (5m)	3	26	54,545	1067	IRCM 93 / 100 L 4b		
	8,8	M8 (5m)	4	31	44,753	1167	IRCM 93 / 112 M 4b		
	11	M8 (5m)	4	38	37,199	970	IRCM 93 / 112 M 4b		
	12	M8 (5m)	4	41	34,034	888	IRCM 93 / 112 M 4b		
	13	M8 (5m)	5,5	45	31,194	1119	IRCM 93 / 132 S 4c		
	2,8	M8 (5m)	1,1	10	133,509	958	IRCM 83 / 90 S 4a		
	3,4	M8 (5m)	1,5	12	121,711	1191	IRCM 83 / 90 L 4a		
	4,0	M8 (5m)	1,5	14	102,407	1002	IRCM 83 / 90 L 4a		
	4,2	M8 (5m)	1,5	15	92,330	903	IRCM 83 / 90 L 4a		
	5,4	M8 (5m)	2,2	19	75,613	1085	IRCM 83 / 100 L 4a		
	6,5	M8 (5m)	3	23	60,299	1180	IRCM 83 / 100 L 4b		
	7,3	M8 (5m)	3	26	54,358	1063	IRCM 83 / 100 L 4b		
8,2	M8 (5m)	3	29	48,314	945	IRCM 83 / 100 L 4b			
9,9	M8 (5m)	4	35	39,796	1038	IRCM 83 / 112 M 4b			
12	M8 (5m)	5,5	42	33,003	1184	IRCM 83 / 132 S 4c			
14	M8 (5m)	5,5	51	27,535	988	IRCM 83 / 132 S 4c			





D _T Tambur Çapı Drum Diameter <i>Diamètre de l'arbre</i> [mm]	V _h Kaldırma Hızı Lifting Speeds <i>Vitesse de levage</i> [m/min]	Vinç Sınıfı Crane Class <i>Classification de l'application de levage</i> ISO (FEM)	P ₁ Motor Gücü Power <i>Puissance</i> [kW]	n ₂ Çıkış Devri Output Speeds <i>Vitesse de sortie</i> [r.p.m]	i Tahvil Ratio <i>Rapport de réduction</i>	M ₂ Çıkış Momenti Output Torque <i>Couple de sortie</i>	Tip Type <i>Typ</i>		 kg
Ø190	2,6	M8 (5m)	1,1	8,6	162,826	1168	IRCM 93 / 90 S 4a		
	2,8	M8 (5m)	1,1	9,5	146,946	1054	IRCM 93 / 90 S 4a		
	3,0	M8 (5m)	1,1	10	133,419	957	IRCM 93 / 90 S 4a		
	3,9	M8 (5m)	1,5	13	111,602	1092	IRCM 93 / 90 L 4a		
	4,8	M8 (5m)	2,2	16	87,936	1262	IRCM 93 / 100 L 4a		
	5,4	M8 (5m)	2,2	18	79,841	1145	IRCM 93 / 100 L 4a		
	6,3	M8 (5m)	2,2	21	66,785	958	IRCM 93 / 100 L 4a		
	6,9	M8 (5m)	3	23	61,444	1202	IRCM 93 / 100 L 4b		
	7,8	M8 (5m)	3	26	54,545	1067	IRCM 93 / 100 L 4b		
	9,2	M8 (5m)	4	31	44,753	1167	IRCM 93 / 112 M 4b		
	11	M8 (5m)	4	38	37,199	970	IRCM 93 / 112 M 4b		
	12	M8 (5m)	5,5	41	34,034	1221	IRCM 93 / 132 S 4c		
	13	M8 (5m)	5,5	45	31,194	1119	IRCM 93 / 132 S 4c		
	3,0	M8 (5m)	1,1	10	133,509	958	IRCM 83 / 90 S 4a		
	3,6	M8 (5m)	1,5	12	121,711	1191	IRCM 83 / 90 L 4a		
	4,2	M8 (5m)	1,5	14	102,407	1002	IRCM 83 / 90 L 4a		
	4,5	M8 (5m)	2,2	15	92,330	1325	IRCM 83 / 100 L 4a		
	5,7	M8 (5m)	2,2	19	75,613	1085	IRCM 83 / 100 L 4a		
	6,9	M8 (5m)	3	23	60,299	1180	IRCM 83 / 100 L 4b		
	7,8	M8 (5m)	3	26	54,358	1063	IRCM 83 / 100 L 4b		
8,7	M8 (5m)	3	29	48,314	945	IRCM 83 / 100 L 4b			
10	M8 (5m)	4	35	39,796	1038	IRCM 83 / 112 M 4b			
13	M7 (4m)	5,5	42	33,003	1184	IRCM 83 / 132 S 4c			
15	M7 (4m)	5,5	51	27,535	988	IRCM 83 / 132 S 4c			
Ø200	2,7	M8 (5m)	1,1	8,6	162,826	1168	IRCM 93 / 90 S 4a		
	3,0	M8 (5m)	1,1	9,5	146,946	1054	IRCM 93 / 90 S 4a		
	3,1	M8 (5m)	1,1	10	133,419	957	IRCM 93 / 90 S 4a		
	4,1	M8 (5m)	1,5	13	111,602	1092	IRCM 93 / 90 L 4a		
	5,0	M8 (5m)	2,2	16	87,936	1262	IRCM 93 / 100 L 4a		
	5,7	M8 (5m)	2,2	18	79,841	1145	IRCM 93 / 100 L 4a		
	6,6	M8 (5m)	3	21	66,785	1307	IRCM 93 / 100 L 4b		
	7,2	M8 (5m)	3	23	61,444	1202	IRCM 93 / 100 L 4b		
	8,2	M8 (5m)	3	26	54,545	1067	IRCM 93 / 100 L 4b		
	9,7	M8 (5m)	4	31	44,753	1167	IRCM 93 / 112 M 4b		
	12	M8 (5m)	5,5	38	37,199	1334	IRCM 93 / 132 S 4c		
	13	M8 (5m)	5,5	41	34,034	1221	IRCM 93 / 132 S 4c		
	14	M8 (5m)	5,5	45	31,194	1119	IRCM 93 / 132 S 4c		
	3,1	M8 (5m)	1,1	10	133,509	958	IRCM 83 / 90 S 4a		
	3,8	M8 (5m)	1,5	12	121,711	1191	IRCM 83 / 90 L 4a		
	4,4	M8 (5m)	2,2	14	102,407	1469	IRCM 83 / 100 L 4a		
	4,7	M8 (5m)	2,2	15	92,330	1325	IRCM 83 / 100 L 4a		
	6,0	M8 (5m)	2,2	19	75,613	1085	IRCM 83 / 100 L 4a		
	7,2	M8 (5m)	3	23	60,299	1180	IRCM 83 / 100 L 4b		
	8,2	M8 (5m)	3	26	54,358	1063	IRCM 83 / 100 L 4b		
9,1	M8 (5m)	4	29	48,314	1260	IRCM 83 / 112 M 4b			
11	M7 (4m)	4	35	39,796	1038	IRCM 83 / 112 M 4b			
13	M7 (4m)	5,5	42	33,003	1184	IRCM 83 / 132 S 4c			
16	M7 (4m)	7,5	51	27,535	1347	IRCM 83 / 132 M 4b			



Vinç sistemleri kaldırma redüktörleri güç ve devir tabloları / Power and ratio table for hoisting applications / Tableau de classification des couples et rapports de réduction pour les applications de levage



Vinç sistemleri kaldırma redüktörleri güç ve devir tabloları / Power and ratio table for hoisting applications / Tableau de classification des couples et rapports de réduction pour les applications de levage

D _T Tambur Çapı Drum Diameter Diamètre de l'arbre [mm]	V _h Kaldırma Hızı Lifting Speeds Vitesse de levage [m/min]	Vinç Sınıfı Crane Class Classification de l'application de levage ISO (FEM)	P ₁ Motor Gücü Power Puissance [kW]	n ₂ Çıkış Devri Output Speeds Vitesse de sortie [r.p.m]	i Tahvil Ratio Rapport de réduction	M ₂ Çıkış Momenti Output Torque Couple de sortie	Tip Type Typ		 kg
Ø210	2,8	M8 (5m)	1,1	8,6	162,826	1168	IRCM 93 / 90 S 4a		
	3,1	M8 (5m)	1,1	9,5	146,946	1054	IRCM 93 / 90 S 4a		
	3,3	M8 (5m)	1,5	10	133,419	1305	IRCM 93 / 90 L 4a		
	4,3	M8 (5m)	1,5	13	111,602	1092	IRCM 93 / 90 L 4a		
	5,3	M8 (5m)	2,2	16	87,936	1262	IRCM 93 / 100 L 4a		
	5,9	M8 (5m)	2,2	18	79,841	1145	IRCM 93 / 100 L 4a		
	6,9	M8 (5m)	3	21	66,785	1307	IRCM 93 / 100 L 4b		
	7,6	M8 (5m)	3	23	61,444	1202	IRCM 93 / 100 L 4b		
	8,6	M8 (5m)	3	26	54,545	1067	IRCM 93 / 100 L 4b		
	10	M8 (5m)	4	31	44,753	1167	IRCM 93 / 112 M 4b		
	13	M8 (5m)	5,5	38	37,199	1334	IRCM 93 / 132 S 4c		
	14	M8 (5m)	5,5	41	34,034	1221	IRCM 93 / 132 S 4c		
	15	M8 (5m)	5,5	45	31,194	1119	IRCM 93 / 132 S 4c		
	3,3	M8 (5m)	1,5	10	133,509	1306	IRCM 83 / 90 L 4a		
	4,0	M8 (5m)	1,5	12	121,711	1191	IRCM 83 / 90 L 4a		
	4,6	M8 (5m)	2,2	14	102,407	1469	IRCM 83 / 100 L 4a		
	4,9	M8 (5m)	2,2	15	92,330	1325	IRCM 83 / 100 L 4a		
	6,3	M7 (4m)	2,2	19	75,613	1085	IRCM 83 / 100 L 4a		
	7,6	M7 (4m)	3	23	60,299	1180	IRCM 83 / 100 L 4b		
	8,6	M7 (4m)	3	26	54,358	1063	IRCM 83 / 100 L 4b		
9,6	M7 (4m)	4	29	48,314	1260	IRCM 83 / 112 M 4b			
12	M7 (4m)	4	35	39,796	1038	IRCM 83 / 112 M 4b			
14	M7 (4m)	5,5	42	33,003	1184	IRCM 83 / 132 S 4c			
17	M7 (4m)	7,5	51	27,535	1347	IRCM 83 / 132 M 4b			
Ø220	3,0	M8 (5m)	1,1	8,6	162,826	1168	IRCM 93 / 90 S 4a		
	3,3	M8 (5m)	1,5	9,5	146,946	1437	IRCM 93 / 90 L 4a		
	3,5	M8 (5m)	1,5	10	133,419	1305	IRCM 93 / 90 L 4a		
	4,5	M8 (5m)	2,2	13	111,602	1601	IRCM 93 / 100 L 4a		
	5,5	M8 (5m)	2,2	16	87,936	1262	IRCM 93 / 100 L 4a		
	6,2	M8 (5m)	2,2	18	79,841	1145	IRCM 93 / 100 L 4a		
	7,3	M8 (5m)	3	21	66,785	1307	IRCM 93 / 100 L 4b		
	7,9	M8 (5m)	3	23	61,444	1202	IRCM 93 / 100 L 4b		
	9,0	M8 (5m)	4	26	54,545	1423	IRCM 93 / 112 M 4b		
	11	M8 (5m)	4	31	44,753	1167	IRCM 93 / 112 M 4b		
	13	M8 (5m)	5,5	38	37,199	1334	IRCM 93 / 132 S 4c		
	14	M8 (5m)	5,5	41	34,034	1221	IRCM 93 / 132 S 4c		
	16	M8 (5m)	5,5	45	31,194	1119	IRCM 93 / 132 S 4c		
	3,5	M7 (4m)	1,5	10	133,509	1306	IRCM 83 / 90 L 4a		
	4,1	M7 (4m)	1,5	12	121,711	1191	IRCM 83 / 90 L 4a		
	4,8	M7 (4m)	2,2	14	102,407	1469	IRCM 83 / 100 L 4a		
	5,2	M7 (4m)	2,2	15	92,330	1325	IRCM 83 / 100 L 4a		
	6,6	M7 (4m)	3	19	75,613	1479	IRCM 83 / 100 L 4b		
	7,9	M7 (4m)	3	23	60,299	1180	IRCM 83 / 100 L 4b		
	9,0	M7 (4m)	4	26	54,358	1418	IRCM 83 / 112 M 4b		
10	M7 (4m)	4	29	48,314	1260	IRCM 83 / 112 M 4b			
12	M7 (4m)	5,5	35	39,796	1427	IRCM 83 / 132 S 4c			
15	M7 (4m)	5,5	42	33,003	1184	IRCM 83 / 132 S 4c			
18	M7 (4m)	7,5	51	27,535	1347	IRCM 83 / 132 M 4b			





D _T Tambur Çapı Drum Diameter <i>Diamètre de l'arbre</i> [mm]	V _h Kaldırma Hızı Lifting Speeds <i>Vitesse de levage</i> [m/min]	Vinç Sınıfı Crane Class <i>Classification de l'application de levage</i> ISO (FEM)	P ₁ Motor Gücü Power <i>Puissance</i> [kW]	n ₂ Çıkış Devri Output Speeds <i>Vitesse de sortie</i> [r.p.m]	i Tahvil Ratio <i>Rapport de réduction</i>	M ₂ Çıkış Momenti Output Torque <i>Couple de sortie</i>	Tip Type <i>Typ</i>		 kg
Ø230	3,1	M8 (5m)	1,1	8,6	162,826	1168	IRCM 93 / 90 S 4a		
	3,4	M8 (5m)	1,5	9,5	146,946	1437	IRCM 93 / 90 L 4a		
	3,6	M8 (5m)	1,5	10	133,419	1305	IRCM 93 / 90 L 4a		
	4,7	M8 (5m)	2,2	13	111,602	1601	IRCM 93 / 100 L 4a		
	5,8	M8 (5m)	2,2	16	87,936	1262	IRCM 93 / 100 L 4a		
	6,5	M8 (5m)	3	18	79,841	1562	IRCM 93 / 100 L 4b		
	7,6	M8 (5m)	3	21	66,785	1307	IRCM 93 / 100 L 4b		
	8,3	M8 (5m)	3	23	61,444	1202	IRCM 93 / 100 L 4b		
	9,4	M8 (5m)	4	26	54,545	1423	IRCM 93 / 112 M 4b		
	11	M8 (5m)	4	31	44,753	1167	IRCM 93 / 112 M 4b		
	14	M8 (5m)	5,5	38	37,199	1334	IRCM 93 / 132 S 4c		
	15	M8 (5m)	5,5	41	34,034	1221	IRCM 93 / 132 S 4c		
	16	M8 (5m)	7,5	45	31,194	1526	IRCM 93 / 132 M 4b		
	3,6	M7 (4m)	1,5	10	133,509	1306	IRCM 83 / 90 L 4a		
	4,3	M7 (4m)	1,5	12	121,711	1191	IRCM 83 / 90 L 4a		
	5,1	M7 (4m)	2,2	14	102,407	1469	IRCM 83 / 100 L 4a		
	5,4	M7 (4m)	2,2	15	92,330	1325	IRCM 83 / 100 L 4a		
	6,9	M7 (4m)	3	19	75,613	1479	IRCM 83 / 100 L 4b		
	8,3	M7 (4m)	3	23	60,299	1180	IRCM 83 / 100 L 4b		
	9,4	M7 (4m)	4	26	54,358	1418	IRCM 83 / 112 M 4b		
10	M7 (4m)	4	29	48,314	1260	IRCM 83 / 112 M 4b			
13	M7 (4m)	5,5	35	39,796	1427	IRCM 83 / 132 S 4c			
15	M7 (4m)	5,5	42	33,003	1184	IRCM 83 / 132 S 4c			
18	M7 (4m)	7,5	51	27,535	1347	IRCM 83 / 132 M 4b			
Ø240	3,2	M8 (5m)	1,5	8,6	162,826	1593	IRCM 93 / 90 L 4a		
	3,6	M8 (5m)	1,5	9,5	146,946	1437	IRCM 93 / 90 L 4a		
	3,8	M8 (5m)	1,5	10	133,419	1305	IRCM 93 / 90 L 4a		
	4,9	M8 (5m)	2,2	13	111,602	1601	IRCM 93 / 100 L 4a		
	6,0	M8 (5m)	2,2	16	87,936	1262	IRCM 93 / 100 L 4a		
	6,8	M8 (5m)	3	18	79,841	1562	IRCM 93 / 100 L 4b		
	7,9	M8 (5m)	3	21	66,785	1307	IRCM 93 / 100 L 4b		
	8,7	M8 (5m)	3	23	61,444	1202	IRCM 93 / 100 L 4b		
	9,8	M8 (5m)	4	26	54,545	1423	IRCM 93 / 112 M 4b		
	12	M8 (5m)	5,5	31	44,753	1605	IRCM 93 / 132 S 4c		
	14	M8 (5m)	5,5	38	37,199	1334	IRCM 93 / 132 S 4c		
	15	M8 (5m)	5,5	41	34,034	1221	IRCM 93 / 132 S 4c		
	17	M8 (5m)	7,5	45	31,194	1526	IRCM 93 / 132 M 4b		
	3,8	M7 (4m)	1,5	10	133,509	1306	IRCM 83 / 90 L 4a		
	4,5	M7 (4m)	2,2	12	121,711	1746	IRCM 83 / 100 L 4a		
	5,3	M7 (4m)	2,2	14	102,407	1469	IRCM 83 / 100 L 4a		
	5,7	M7 (4m)	2,2	15	92,330	1325	IRCM 83 / 100 L 4a		
	7,2	M7 (4m)	3	19	75,613	1479	IRCM 83 / 100 L 4b		
	8,7	M7 (4m)	3	23	60,299	1180	IRCM 83 / 100 L 4b		
	9,8	M7 (4m)	4	26	54,358	1418	IRCM 83 / 112 M 4b		
11	M7 (4m)	4	29	48,314	1260	IRCM 83 / 112 M 4b			
13	M7 (4m)	5,5	35	39,796	1427	IRCM 83 / 132 S 4c			
16	M6 (3m)	5,5	42	33,003	1184	IRCM 83 / 132 S 4c			
19	M6 (3m)	7,5	51	27,535	1347	IRCM 83 / 132 M 4b			



Vinç sistemleri kaldırma redüktörleri güç ve devir tabloları / Power and ratio table for hoisting applications / Tableau de classification des couples et rapports de réduction pour les applications de levage



Vinç sistemleri kaldırma redüktörleri güç ve devir tabloları / Power and ratio table for hoisting applications / Tableau de classification des couples et rapports de réduction pour les applications de levage

D _T Tambur Çapı Drum Diameter <i>Diamètre de l'arbre</i> [mm]	V _h Kaldırma Hızı Lifting Speeds <i>Vitesse de levage</i> [m/min]	Vinç Sınıfı Crane Class <i>Classification de l'application de levage</i> ISO (FEM)	P ₁ Motor Gücü Power <i>Puissance</i> [kW]	n ₂ Çıkış Devri Output Speeds <i>Vitesse de sortie</i> [r.p.m]	i Tahvil Ratio <i>Rapport de réduction</i>	M ₂ Çıkış Momenti Output Torque <i>Couple de sortie</i>	Tip Type <i>Typ</i>		 kg
Ø110	1,0	M8 (5m)	0,37	12	120,792	291	IRCM 73 / 71 M 4b		
	1,1	M8 (5m)	0,55	13	107,423	385	IRCM 73 / 80 M 4a		
	1,3	M8 (5m)	0,55	15	96,194	345	IRCM 73 / 80 M 4a		
	1,4	M8 (5m)	0,55	16	86,628	311	IRCM 73 / 80 M 4a		
	1,6	M8 (5m)	0,75	19	73,889	361	IRCM 73 / 80 M 4b		
	1,8	M8 (5m)	0,75	21	65,252	319	IRCM 73 / 80 M 4b		
	2,1	M8 (5m)	0,75	24	57,996	284	IRCM 73 / 80 M 4b		
	2,3	M8 (5m)	1,1	27	51,846	372	IRCM 73 / 90 S 4a		
	2,8	M8 (5m)	1,1	33	41,848	300	IRCM 73 / 90 S 4a		
	3,4	M8 (5m)	1,5	39	35,564	348	IRCM 73 / 90 L 4a		
	3,8	M8 (5m)	1,5	44	32,098	314	IRCM 73 / 90 L 4a		
	4,6	M8 (5m)	2,2	53	26,291	377	IRCM 73 / 100 L 4a		
Ø120	5,1	M8 (5m)	2,2	59	23,834	342	IRCM 73 / 100 L 4a		
	1,1	M8 (5m)	0,55	12	120,792	433	IRCM 73 / 80 M 4a		
	1,2	M8 (5m)	0,55	13	107,423	385	IRCM 73 / 80 M 4a		
	1,4	M8 (5m)	0,55	15	96,194	345	IRCM 73 / 80 M 4a		
	1,5	M8 (5m)	0,55	16	86,628	311	IRCM 73 / 80 M 4a		
	1,8	M8 (5m)	0,75	19	73,889	361	IRCM 73 / 80 M 4b		
	2,0	M8 (5m)	0,75	21	65,252	319	IRCM 73 / 80 M 4b		
	2,3	M8 (5m)	1,1	24	57,996	416	IRCM 73 / 90 S 4a		
	2,5	M8 (5m)	1,1	27	51,846	372	IRCM 73 / 90 S 4a		
	3,1	M8 (5m)	1,1	33	41,848	300	IRCM 73 / 90 S 4a		
	3,7	M8 (5m)	1,5	39	35,564	348	IRCM 73 / 90 L 4a		
	4,1	M8 (5m)	1,5	44	32,098	314	IRCM 73 / 90 L 4a		
Ø130	5,0	M8 (5m)	2,2	53	26,291	377	IRCM 73 / 100 L 4a		
	5,6	M8 (5m)	2,2	59	23,834	342	IRCM 73 / 100 L 4a		
	1,2	M8 (5m)	0,55	12	120,792	433	IRCM 73 / 80 M 4a		
	1,3	M8 (5m)	0,55	13	107,423	385	IRCM 73 / 80 M 4a		
	1,5	M8 (5m)	0,55	15	96,194	345	IRCM 73 / 80 M 4a		
	1,6	M8 (5m)	0,75	16	86,628	424	IRCM 73 / 80 M 4b		
	1,9	M8 (5m)	0,75	19	73,889	361	IRCM 73 / 80 M 4b		
	2,1	M8 (5m)	0,75	21	65,252	319	IRCM 73 / 80 M 4b		
	2,4	M8 (5m)	1,1	24	57,996	416	IRCM 73 / 90 S 4a		
	2,8	M8 (5m)	1,1	27	51,846	372	IRCM 73 / 90 S 4a		
	3,4	M8 (5m)	1,5	33	41,848	409	IRCM 73 / 90 L 4a		
	4,0	M8 (5m)	1,5	39	35,564	348	IRCM 73 / 90 L 4a		
Ø140	4,5	M8 (5m)	2,2	44	32,098	461	IRCM 73 / 100 L 4a		
	5,4	M8 (5m)	2,2	53	26,291	377	IRCM 73 / 100 L 4a		
	6,0	M8 (5m)	2,2	59	23,834	342	IRCM 73 / 100 L 4a		
	1,3	M8 (5m)	0,55	12	120,792	433	IRCM 73 / 80 M 4a		
	1,4	M8 (5m)	0,55	13	107,423	385	IRCM 73 / 80 M 4a		
	1,6	M8 (5m)	0,75	15	96,194	470	IRCM 73 / 80 M 4b		
	1,8	M8 (5m)	0,75	16	86,628	424	IRCM 73 / 80 M 4b		
	2,1	M8 (5m)	0,75	19	73,889	361	IRCM 73 / 80 M 4b		
	2,3	M8 (5m)	1,1	21	65,252	468	IRCM 73 / 90 S 4a		
	2,6	M8 (5m)	1,1	24	57,996	416	IRCM 73 / 90 S 4a		
	3,0	M8 (5m)	1,1	27	51,846	372	IRCM 73 / 90 S 4a		
	3,6	M8 (5m)	1,5	33	41,848	409	IRCM 73 / 90 L 4a		
4,3	M8 (5m)	1,5	39	35,564	348	IRCM 73 / 90 L 4a			
4,8	M8 (5m)	2,2	44	32,098	461	IRCM 73 / 100 L 4a			
5,8	M8 (5m)	2,2	53	26,291	377	IRCM 73 / 100 L 4a			
6,5	M8 (5m)	3	59	23,834	466	IRCM 73 / 100 L 4b			



D _T Tambur Çapı Drum Diameter <i>Diamètre de l'arbre</i> [mm]	V _h Kaldırma Hızı Lifting Speeds <i>Vitesse de levage</i> [m/min]	Vinç Sınıfı Crane Class <i>Classification de l'application de levage</i> ISO (FEM)	P ₁ Motor Gücü Power <i>Puissance</i> [kW]	n ₂ Çıkış Devri Output Speeds <i>Vitesse de sortie</i> [r.p.m]	i Tahvil Ratio <i>Rapport de réduction</i>	M ₂ Çıkış Momenti Output Torque <i>Couple de sortie</i>	Tip Type <i>Typ</i>		 kg
Ø150	1,4	M8 (5m)	0,55	12	120,792	433	IRCM 73 / 80 M 4a		
	1,5	M8 (5m)	0,55	13	107,423	385	IRCM 73 / 80 M 4a		
	1,8	M8 (5m)	0,75	15	96,194	470	IRCM 73 / 80 M 4b		
	1,9	M8 (5m)	0,75	16	86,628	424	IRCM 73 / 80 M 4b		
	2,2	M8 (5m)	1,1	19	73,889	530	IRCM 73 / 90 S 4a		
	2,5	M8 (5m)	1,1	21	65,252	468	IRCM 73 / 90 S 4a		
	2,8	M8 (5m)	1,1	24	57,996	416	IRCM 73 / 90 S 4a		
	3,2	M8 (5m)	1,1	27	51,846	372	IRCM 73 / 90 S 4a		
	3,9	M8 (5m)	1,5	33	41,848	409	IRCM 73 / 90 L 4a		
	4,6	M8 (5m)	2,2	39	35,564	510	IRCM 73 / 100 L 4a		
	5,2	M8 (5m)	2,2	44	32,098	461	IRCM 73 / 100 L 4a		
	6,2	M8 (5m)	2,2	53	26,291	377	IRCM 73 / 100 L 4a		
Ø160	1,5	M8 (5m)	0,55	12	120,792	433	IRCM 73 / 80 M 4a		
	1,6	M8 (5m)	0,75	13	107,423	525	IRCM 73 / 80 M 4b		
	1,9	M8 (5m)	0,75	15	96,194	470	IRCM 73 / 80 M 4b		
	2,0	M8 (5m)	0,75	16	86,628	424	IRCM 73 / 80 M 4b		
	2,4	M8 (5m)	1,1	19	73,889	530	IRCM 73 / 90 S 4a		
	2,6	M8 (5m)	1,1	21	65,252	468	IRCM 73 / 90 S 4a		
	3,0	M8 (5m)	1,1	24	57,996	416	IRCM 73 / 90 S 4a		
	3,4	M8 (5m)	1,5	27	51,846	507	IRCM 73 / 90 L 4a		
	4,1	M8 (5m)	1,5	33	41,848	409	IRCM 73 / 90 L 4a		
	4,9	M8 (5m)	2,2	39	35,564	510	IRCM 73 / 100 L 4a		
	5,5	M8 (5m)	2,2	44	32,098	461	IRCM 73 / 100 L 4a		
	6,7	M8 (5m)	3	53	26,291	514	IRCM 73 / 100 L 4b		
Ø170	1,6	M8 (5m)	0,75	12	120,792	591	IRCM 73 / 80 M 4b		
	1,7	M8 (5m)	0,75	13	107,423	525	IRCM 73 / 80 M 4b		
	2,0	M8 (5m)	0,75	15	96,194	470	IRCM 73 / 80 M 4b		
	2,1	M8 (5m)	0,75	16	86,628	424	IRCM 73 / 80 M 4b		
	2,5	M8 (5m)	1,1	19	73,889	530	IRCM 73 / 90 S 4a		
	2,8	M8 (5m)	1,1	21	65,252	468	IRCM 73 / 90 S 4a		
	3,2	M8 (5m)	1,5	24	57,996	567	IRCM 73 / 90 L 4a		
	3,6	M8 (5m)	1,5	27	51,846	507	IRCM 73 / 90 L 4a		
	4,4	M8 (5m)	2,2	33	41,848	600	IRCM 73 / 100 L 4a		
	5,2	M8 (5m)	2,2	39	35,564	510	IRCM 73 / 100 L 4a		
	5,9	M8 (5m)	2,2	44	32,098	461	IRCM 73 / 100 L 4a		
	7,1	M8 (5m)	3	53	26,291	514	IRCM 73 / 100 L 4b		
Ø180	1,7	M8 (5m)	0,75	12	120,792	591	IRCM 73 / 80 M 4b		
	1,8	M8 (5m)	0,75	13	107,423	525	IRCM 73 / 80 M 4b		
	2,1	M8 (5m)	0,75	15	96,194	470	IRCM 73 / 80 M 4b		
	2,3	M8 (5m)	1,1	16	86,628	621	IRCM 73 / 90 S 4a		
	2,7	M8 (5m)	1,1	19	73,889	530	IRCM 73 / 90 S 4a		
	3,0	M8 (5m)	1,1	21	65,252	468	IRCM 73 / 90 S 4a		
	3,4	M8 (5m)	1,5	24	57,996	567	IRCM 73 / 90 L 4a		
	3,8	M8 (5m)	1,5	27	51,846	507	IRCM 73 / 90 L 4a		
	4,7	M8 (5m)	2,2	33	41,848	600	IRCM 73 / 100 L 4a		
	5,5	M8 (5m)	2,2	39	35,564	510	IRCM 73 / 100 L 4a		
	6,2	M8 (5m)	2,2	44	32,098	461	IRCM 73 / 100 L 4a		
	7,5	M8 (5m)	3	53	26,291	514	IRCM 73 / 100 L 4b		
8,3	M8 (5m)	3	59	23,834	466	IRCM 73 / 100 L 4b			



Vinç sistemleri kaldırma redüktörleri güç ve devir tabloları / Power and ratio table for hoisting applications / Tableau de classification des couples et rapports de réduction pour les applications de levage



D _T Tambur Çapı Drum Diameter <i>Diamètre de l'arbre</i> [mm]	V _h Kaldırma Hızı Lifting Speeds <i>Vitesse de levage</i> [m/min]	Vinç Sınıfı Crane Class <i>Classification de l'application de levage</i> ISO (FEM)	P ₁ Motor Gücü Power <i>Puissance</i> [kW]	n ₂ Çıkış Devri Output Speeds <i>Vitesse de sortie</i> [r.p.m]	i Tahvil Ratio <i>Rapport de réduction</i>	M ₂ Çıkış Momenti Output Torque <i>Couple de sortie</i>	Tip Type <i>Typ</i>		 kg
Ø270	5,9	M8 (5m)	3	7,0	199,476	3903	IRCM 103 / 100 L 4b		
	6,7	M8 (5m)	3	7,9	177,284	3468	IRCM 103 / 100 L 4b		
	8,3	M8 (5m)	4	10	143,552	3745	IRCM 103 / 112 M 4b		
	10,2	M8 (5m)	5,5	12	119,126	4273	IRCM 103 / 132 S 4c		
	11,0	M8 (5m)	5,5	13	109,276	3919	IRCM 103 / 132 S 4c		
	12,7	M8 (5m)	5,5	15	95,896	3440	IRCM 103 / 132 S 4c		
	15,3	M8 (5m)	7,5	18	78,692	3849	IRCM 103 / 132 M 4b		
	16,1	M8 (5m)	7,5	19	71,869	3515	IRCM 103 / 132 M 4b		
	20,3	M8 (5m)	9,2	24	58,778	3526	IRCM 103 / 132 M 4c		
	22,9	M8 (5m)	11	27	51,907	3724	IRCM 103 / 160 M 4b		
	7,3	M7 (4m)	4	8,6	162,826	4247	IRCM 93 / 112 M 4b		
	8,1	M7 (4m)	4	9,5	146,946	3833	IRCM 93 / 112 M 4b		
	8,5	M7 (4m)	4	10	133,419	3480	IRCM 93 / 112 M 4b		
	11	M7 (4m)	5,5	13	111,602	4003	IRCM 93 / 132 S 4c		
	14	M6 (3m)	7,5	16	87,936	4301	IRCM 93 / 132 M 4b		
	15	M6 (3m)	7,5	18	79,841	3905	IRCM 93 / 132 M 4b		
	18	M6 (3m)	9,2	21	66,785	4007	IRCM 93 / 132 M 4c		
	19	M6 (3m)	9,2	23	61,444	3686	IRCM 93 / 132 M 4c		
	22	M6 (3m)	11	26	54,545	3913	IRCM 93 / 160 M 4b		
	26	M5 (2m)	15	31	44,753	4378	IRCM 93 / 160 L 4a		
32	M5 (2m)	15	38	37,199	3639	IRCM 93 / 160 L 4a			
35	M5 (2m)	15	41	34,034	3329	IRCM 93 / 160 L 4a			
38	M5 (2m)	18,5	45	31,194	3763	IRCM 93 / 180 M 4b			
Ø280	6,2	M8 (5m)	3	7,0	199,476	3903	IRCM 103 / 100 L 4b		
	6,9	M8 (5m)	3	7,9	177,284	3468	IRCM 103 / 100 L 4b		
	8,6	M8 (5m)	4	10	143,552	3745	IRCM 103 / 112 M 4b		
	10,6	M8 (5m)	5,5	12	119,126	4273	IRCM 103 / 132 S 4c		
	11,4	M8 (5m)	5,5	13	109,276	3919	IRCM 103 / 132 S 4c		
	13,2	M8 (5m)	7,5	15	95,896	4690	IRCM 103 / 132 M 4b		
	15,8	M8 (5m)	7,5	18	78,692	3849	IRCM 103 / 132 M 4b		
	16,7	M8 (5m)	7,5	19	71,869	3515	IRCM 103 / 132 M 4b		
	21,1	M8 (5m)	9,2	24	58,778	3526	IRCM 103 / 132 M 4c		
	23,7	M8 (5m)	11	27	51,907	3724	IRCM 103 / 160 M 4b		
	7,6	M7 (4m)	4	8,6	162,826	4247	IRCM 93 / 112 M 4b		
	8,4	M7 (4m)	4	9,5	146,946	3833	IRCM 93 / 112 M 4b		
	8,8	M6 (3m)	4	10	133,419	3480	IRCM 93 / 112 M 4b		
	11	M6 (3m)	5,5	13	111,602	4003	IRCM 93 / 132 S 4c		
	14	M6 (3m)	7,5	16	87,936	4301	IRCM 93 / 132 M 4b		
	16	M6 (3m)	7,5	18	79,841	3905	IRCM 93 / 132 M 4b		
	18	M6 (3m)	9,2	21	66,785	4007	IRCM 93 / 132 M 4c		
	20	M6 (3m)	9,2	23	61,444	3686	IRCM 93 / 132 M 4c		
	23	M6 (3m)	11	26	54,545	3913	IRCM 93 / 160 M 4b		
	27	M5 (2m)	15	31	44,753	4378	IRCM 93 / 160 L 4a		
33	M5 (2m)	15	38	37,199	3639	IRCM 93 / 160 L 4a			
36	M5 (2m)	18,5	41	34,034	4106	IRCM 93 / 180 M 4b			
40	M5 (2m)	18,5	45	31,194	3763	IRCM 93 / 180 M 4b			
	6,4	M8 (5m)	3	7,0	199,476	3903	IRCM 103 / 100 L 4b		
	7,2	M8 (5m)	4	7,9	177,284	4624	IRCM 103 / 112 M 4b		
	8,9	M8 (5m)	4	10	143,552	3745	IRCM 103 / 112 M 4b		
	10,9	M8 (5m)	5,5	12	119,126	4273	IRCM 103 / 132 S 4c		
	11,8	M8 (5m)	5,5	13	109,276	3919	IRCM 103 / 132 S 4c		
	13,7	M8 (5m)	7,5	15	95,896	4690	IRCM 103 / 132 M 4b		
	16,4	M8 (5m)	7,5	18	78,692	3849	IRCM 103 / 132 M 4b		
	17,3	M8 (5m)	7,5	19	71,869	3515	IRCM 103 / 132 M 4b		
	21,9	M8 (5m)	11	24	58,778	4216	IRCM 103 / 160 M 4b		
	24,6	M8 (5m)	11	27	51,907	3724	IRCM 103 / 160 M 4b		





D _T Tambur Çapı Drum Diameter <i>Diamètre de l'arbre</i> [mm]	V _h Kaldırma Hızı Lifting Speeds <i>Vitesse de levage</i> [m/min]	Vinç Sınıfı Crane Class <i>Classification de l'application de levage</i> ISO (FEM)	P ₁ Motor Gücü Power <i>Puissance</i> [kW]	n ₂ Çıkış Devri Output Speeds <i>Vitesse de sortie</i> [r.p.m]	i Tahvil Ratio <i>Rapport de réduction</i>	M ₂ Çıkış Momenti Output Torque <i>Couple de sortie</i>	Tip Type <i>Typ</i>			kg
Ø290	7,8	M6 (3m)	4	8,6	162,826	4247	IRCM 93 / 112 M 4b			
	8,7	M6 (3m)	4	9,5	146,946	3833	IRCM 93 / 112 M 4b			
	9,1	M6 (3m)	4	10	133,419	3480	IRCM 93 / 112 M 4b			
	12	M6 (3m)	5,5	13	111,602	4003	IRCM 93 / 132 S 4c			
	15	M6 (3m)	7,5	16	87,936	4301	IRCM 93 / 132 M 4b			
	16	M6 (3m)	7,5	18	79,841	3905	IRCM 93 / 132 M 4b			
	19	M6 (3m)	9,2	21	66,785	4007	IRCM 93 / 132 M 4c			
	21	M6 (3m)	9,2	23	61,444	3686	IRCM 93 / 132 M 4c			
	24	M5 (2m)	11	26	54,545	3913	IRCM 93 / 160 M 4b			
	28	M5 (2m)	15	31	44,753	4378	IRCM 93 / 160 L 4a			
	35	M5 (2m)	15	38	37,199	3639	IRCM 93 / 160 L 4a			
	37	M5 (2m)	18,5	41	34,034	4106	IRCM 93 / 180 M 4b			
41	M5 (2m)	18,5	45	31,194	3763	IRCM 93 / 180 M 4b				
Ø300	6,6	M8 (5m)	3	7,0	199,476	3903	IRCM 103 / 100 L 4b			
	7,4	M8 (5m)	4	7,9	177,284	4624	IRCM 103 / 112 M 4b			
	9,2	M8 (5m)	4	10	143,552	3745	IRCM 103 / 112 M 4b			
	11,3	M8 (5m)	5,5	12	119,126	4273	IRCM 103 / 132 S 4c			
	12,2	M8 (5m)	5,5	13	109,276	3919	IRCM 103 / 132 S 4c			
	14,1	M8 (5m)	7,5	15	95,896	4690	IRCM 103 / 132 M 4b			
	17,0	M8 (5m)	7,5	18	78,692	3849	IRCM 103 / 132 M 4b			
	17,9	M8 (5m)	9,2	19	71,869	4312	IRCM 103 / 132 M 4c			
	22,6	M8 (5m)	11	24	58,778	4216	IRCM 103 / 160 M 4b			
	25,4	M8 (5m)	11	27	51,907	3724	IRCM 103 / 160 M 4b			
	8,1	M6 (3m)	4	8,6	162,826	4247	IRCM 93 / 112 M 4b			
	8,9	M6 (3m)	4	9,5	146,946	3833	IRCM 93 / 112 M 4b			
	9,4	M6 (3m)	5,5	10	133,419	4785	IRCM 93 / 132 S 4c			
	12	M6 (3m)	5,5	13	111,602	4003	IRCM 93 / 132 S 4c			
	15	M6 (3m)	7,5	16	87,936	4301	IRCM 93 / 132 M 4b			
	17	M6 (3m)	7,5	18	79,841	3905	IRCM 93 / 132 M 4b			
	20	M5 (2m)	9,2	21	66,785	4007	IRCM 93 / 132 M 4c			
	22	M5 (2m)	11	23	61,444	4408	IRCM 93 / 160 M 4b			
	24	M5 (2m)	11	26	54,545	3913	IRCM 93 / 160 M 4b			
	29	M5 (2m)	15	31	44,753	4378	IRCM 93 / 160 L 4a			
36	M4 (1Am)	18,5	38	37,199	4488	IRCM 93 / 180 M 4b				
39	M4 (1Am)	18,5	41	34,034	4106	IRCM 93 / 180 M 4b				
42	M4 (1Am)	18,5	45	31,194	3763	IRCM 93 / 180 M 4b				
6,8	M8 (5m)	3	7,0	199,476	3903	IRCM 103 / 100 L 4b				
7,7	M8 (5m)	4	7,9	177,284	4624	IRCM 103 / 112 M 4b				
9,5	M8 (5m)	5,5	10	143,552	5149	IRCM 103 / 132 S 4c				
11,7	M8 (5m)	5,5	12	119,126	4273	IRCM 103 / 132 S 4c				
12,7	M8 (5m)	5,5	13	109,276	3919	IRCM 103 / 132 S 4c				
14,6	M8 (5m)	7,5	15	95,896	4690	IRCM 103 / 132 M 4b				
17,5	M8 (5m)	9,2	18	78,692	4721	IRCM 103 / 132 M 4c				
18,5	M8 (5m)	9,2	19	71,869	4312	IRCM 103 / 132 M 4c				
23,4	M8 (5m)	11	24	58,778	4216	IRCM 103 / 160 M 4b				
26,3	M8 (5m)	15	27	51,907	5078	IRCM 103 / 160 L 4a				



Vinç sistemleri kaldırma redüktörleri güç ve devir tabloları / Power and ratio table for hoisting applications / Tableau de classification des couples et rapports de réduction pour les applications de levage



D _T Tambur Çapı Drum Diameter <i>Diamètre de l'arbre</i> [mm]	V _h Kaldırma Hızı Lifting Speeds <i>Vitesse de levage</i> [m/min]	Vinç Sınıfı Crane Class <i>Classification de l'application de levage</i> ISO (FEM)	P ₁ Motor Gücü Power <i>Puissance</i> [kW]	n ₂ Çıkış Devri Output Speeds <i>Vitesse de sortie</i> [r.p.m]	i Tahvil Ratio <i>Rapport de réduction</i>	M ₂ Çıkış Momenti Output Torque <i>Couple de sortie</i>	Tip Type <i>Typ</i>		 kg
Ø310	8,4	M6 (3m)	4	8,6	162,826	4247	IRCM 93 / 112 M 4b		
	9,2	M6 (3m)	4	9,5	146,946	3833	IRCM 93 / 112 M 4b		
	9,7	M6 (3m)	5,5	10	133,419	4785	IRCM 93 / 132 S 4c		
	13	M6 (3m)	5,5	13	111,602	4003	IRCM 93 / 132 S 4c		
	16	M6 (3m)	7,5	16	87,936	4301	IRCM 93 / 132 M 4b		
	18	M5 (2m)	9,2	18	79,841	4790	IRCM 93 / 132 M 4c		
	20	M5 (2m)	9,2	21	66,785	4007	IRCM 93 / 132 M 4c		
	22	M5 (2m)	11	23	61,444	4408	IRCM 93 / 160 M 4b		
	25	M5 (2m)	11	26	54,545	3913	IRCM 93 / 160 M 4b		
	30	M4 (1Am)	15	31	44,753	4378	IRCM 93 / 160 L 4a		
	37	M4 (1Am)	18,5	38	37,199	4488	IRCM 93 / 180 M 4b		
	40	M4 (1Am)	18,5	41	34,034	4106	IRCM 93 / 180 M 4b		
44	M4 (1Am)	22	45	31,194	4475	IRCM 93 / 180 L 4b			
Ø320	7,0	M8 (5m)	4	7,0	199,476	5203	IRCM 103 / 112 M 4b		
	7,9	M8 (5m)	4	7,9	177,284	4624	IRCM 103 / 112 M 4b		
	9,8	M8 (5m)	5,5	10	143,552	5149	IRCM 103 / 132 S 4c		
	12,1	M8 (5m)	5,5	12	119,126	4273	IRCM 103 / 132 S 4c		
	13,1	M8 (5m)	7,5	13	109,276	5345	IRCM 103 / 132 M 4b		
	15,1	M8 (5m)	7,5	15	95,896	4690	IRCM 103 / 132 M 4b		
	18,1	M8 (5m)	9,2	18	78,692	4721	IRCM 103 / 132 M 4c		
	19,1	M8 (5m)	9,2	19	71,869	4312	IRCM 103 / 132 M 4c		
	24,1	M8 (5m)	11	24	58,778	4216	IRCM 103 / 160 M 4b		
	27,1	M8 (5m)	15	27	51,907	5078	IRCM 103 / 160 L 4a		
	8,6	M6 (3m)	4	8,6	162,826	4247	IRCM 93 / 112 M 4b		
	9,5	M6 (3m)	5,5	9,5	146,946	5271	IRCM 93 / 132 S 4c		
	10	M6 (3m)	5,5	10	133,419	4785	IRCM 93 / 132 S 4c		
	13	M6 (3m)	7,5	13	111,602	5458	IRCM 93 / 132 M 4b		
	16	M5 (2m)	7,5	16	87,936	4301	IRCM 93 / 132 M 4b		
	18	M5 (2m)	9,2	18	79,841	4790	IRCM 93 / 132 M 4c		
	21	M5 (2m)	9,2	21	66,785	4007	IRCM 93 / 132 M 4c		
	23	M5 (2m)	11	23	61,444	4408	IRCM 93 / 160 M 4b		
26	M4 (1Am)	15	26	54,545	5336	IRCM 93 / 160 L 4a			
31	M4 (1Am)	15	31	44,753	4378	IRCM 93 / 160 L 4a			
Ø330	7,3	M8 (5m)	4	7,0	199,476	5203	IRCM 103 / 112 M 4b		
	8,2	M8 (5m)	4	7,9	177,284	4624	IRCM 103 / 112 M 4b		
	10,2	M8 (5m)	5,5	10	143,552	5149	IRCM 103 / 132 S 4c		
	12,4	M8 (5m)	5,5	12	119,126	4273	IRCM 103 / 132 S 4c		
	13,5	M8 (5m)	7,5	13	109,276	5345	IRCM 103 / 132 M 4b		
	15,5	M8 (5m)	7,5	15	95,896	4690	IRCM 103 / 132 M 4b		
	18,7	M8 (5m)	9,2	18	78,692	4721	IRCM 103 / 132 M 4c		
	19,7	M8 (5m)	9,2	19	71,869	4312	IRCM 103 / 132 M 4c		
	24,9	M8 (5m)	11	24	58,778	4216	IRCM 103 / 160 M 4b		
	28,0	M8 (5m)	15	27	51,907	5078	IRCM 103 / 160 L 4a		
	8,9	M6 (3m)	4	8,6	162,826	4247	IRCM 93 / 112 M 4b		
	10	M6 (3m)	5,5	9,5	146,946	5271	IRCM 93 / 132 S 4c		
	10	M6 (3m)	5,5	10	133,419	4785	IRCM 93 / 132 S 4c		
	13	M6 (3m)	7,5	13	111,602	5458	IRCM 93 / 132 M 4b		
	17	M5 (2m)	7,5	16	87,936	4301	IRCM 93 / 132 M 4b		
	19	M5 (2m)	9,2	18	79,841	4790	IRCM 93 / 132 M 4c		
	22	M5 (2m)	11	21	66,785	4791	IRCM 93 / 160 M 4b		
	24	M5 (2m)	11	23	61,444	4408	IRCM 93 / 160 M 4b		
27	M4 (1Am)	15	26	54,545	5336	IRCM 93 / 160 L 4a			
32	M4 (1Am)	15	31	44,753	4378	IRCM 93 / 160 L 4a			





D _T Tambur Çapı Drum Diameter <i>Diamètre de l'arbre</i> [mm]	V _h Kaldırma Hızı Lifting Speeds <i>Vitesse de levage</i> [m/min]	Vinç Sınıfı Crane Class <i>Classification de l'application de levage</i> ISO (FEM)	P ₁ Motor Gücü Power <i>Puissance</i> [kW]	n ₂ Çıkış Devri Output Speeds <i>Vitesse de sortie</i> [r.p.m]	i Tahvil Ratio <i>Rapport de réduction</i>	M ₂ Çıkış Momenti Output Torque <i>Couple de sortie</i>	Tip Type <i>Typ</i>		 kg
Ø340	7,5	M8 (5m)	4	7,0	199,476	5203	IRCM 103 / 112 M 4b		
	8,4	M8 (5m)	4	7,9	177,284	4624	IRCM 103 / 112 M 4b		
	10,5	M8 (5m)	5,5	10	143,552	5149	IRCM 103 / 132 S 4c		
	12,8	M8 (5m)	7,5	12	119,126	5826	IRCM 103 / 132 M 4b		
	13,9	M8 (5m)	7,5	13	109,276	5345	IRCM 103 / 132 M 4b		
	16,0	M8 (5m)	7,5	15	95,896	4690	IRCM 103 / 132 M 4b		
	19,2	M8 (5m)	9,2	18	78,692	4721	IRCM 103 / 132 M 4c		
	20,3	M8 (5m)	9,2	19	71,869	4312	IRCM 103 / 132 M 4c		
	25,6	M8 (5m)	15	24	58,778	5750	IRCM 103 / 160 L 4a		
	28,8	M8 (5m)	15	27	51,907	5078	IRCM 103 / 160 L 4a		
	9,2	M7 (4m)	4	8,6	162,826	4247	IRCM 93 / 112 M 4b		
	10	M7 (4m)	5,5	9,5	146,946	5271	IRCM 93 / 132 S 4c		
	11	M6 (3m)	5,5	10	133,419	4785	IRCM 93 / 132 S 4c		
	14	M6 (3m)	7,5	13	111,602	5458	IRCM 93 / 132 M 4b		
	17	M6 (3m)	7,5	16	87,936	4301	IRCM 93 / 132 M 4b		
	19	M6 (3m)	9,2	18	79,841	4790	IRCM 93 / 132 M 4c		
	22	M6 (3m)	11	21	66,785	4791	IRCM 93 / 160 M 4b		
	25	M6 (3m)	11	23	61,444	4408	IRCM 93 / 160 M 4b		
28	M5 (2m)	15	26	54,545	5336	IRCM 93 / 160 L 4a			
33	M5 (2m)	15	31	44,753	4378	IRCM 93 / 160 L 4a			
Ø360	7,9	M8 (5m)	4	7,0	199,476	5203	IRCM 103 / 112 M 4b		
	8,9	M8 (5m)	4	7,9	177,284	4624	IRCM 103 / 112 M 4b		
	11,1	M8 (5m)	5,5	10	143,552	5149	IRCM 103 / 132 S 4c		
	13,6	M8 (5m)	7,5	12	119,126	5826	IRCM 103 / 132 M 4b		
	14,7	M8 (5m)	7,5	13	109,276	5345	IRCM 103 / 132 M 4b		
	17,0	M8 (5m)	7,5	15	95,896	4690	IRCM 103 / 132 M 4b		
	20,3	M8 (5m)	9,2	18	78,692	4721	IRCM 103 / 132 M 4c		
	21,5	M8 (5m)	11	19	71,869	5155	IRCM 103 / 160 M 4b		
	27,1	M8 (5m)	15	24	58,778	5750	IRCM 103 / 160 L 4a		
	30,5	M8 (5m)	15	27	51,907	5078	IRCM 103 / 160 L 4a		
Ø380	8,4	M8 (5m)	4	7,0	199,476	5203	IRCM 103 / 112 M 4b		
	9,4	M8 (5m)	5,5	7,9	177,284	6359	IRCM 103 / 132 S 4c		
	11,7	M8 (5m)	5,5	10	143,552	5149	IRCM 103 / 132 S 4c		
	14,3	M8 (5m)	7,5	12	119,126	5826	IRCM 103 / 132 M 4b		
	15,5	M8 (5m)	7,5	13	109,276	5345	IRCM 103 / 132 M 4b		
	17,9	M8 (5m)	9,2	15	95,896	5753	IRCM 103 / 132 M 4c		
	21,5	M8 (5m)	11	18	78,692	5645	IRCM 103 / 160 M 4b		
	22,7	M8 (5m)	11	19	71,869	5155	IRCM 103 / 160 M 4b		
	28,6	M8 (5m)	15	24	58,778	5750	IRCM 103 / 160 L 4a		
	32,2	M8 (5m)	15	27	51,907	5078	IRCM 103 / 160 L 4a		
Ø400	8,8	M8 (5m)	4	7,0	199,476	5203	IRCM 103 / 112 M 4b		
	9,9	M8 (5m)	5,5	7,9	177,284	6359	IRCM 103 / 132 S 4c		
	12,3	M8 (5m)	5,5	10	143,552	5149	IRCM 103 / 132 S 4c		
	15,1	M8 (5m)	7,5	12	119,126	5826	IRCM 103 / 132 M 4b		
	16,3	M8 (5m)	7,5	13	109,276	5345	IRCM 103 / 132 M 4b		
	18,8	M8 (5m)	9,2	15	95,896	5753	IRCM 103 / 132 M 4c		
	22,6	M8 (5m)	11	18	78,692	5645	IRCM 103 / 160 M 4b		
	23,9	M8 (5m)	11	19	71,869	5155	IRCM 103 / 160 M 4b		
	30,1	M8 (5m)	15	24	58,778	5750	IRCM 103 / 160 L 4a		
	33,9	M8 (5m)	15	27	51,907	5078	IRCM 103 / 160 L 4a		



Vinç sistemleri kaldırma redüktörleri güç ve devir tabloları / Power and ratio table for hoisting applications / Tableau de classification des couples et rapports de réduction pour les applications de levage



D _T Tambur Çapı Drum Diameter <i>Diamètre de l'arbre</i> [mm]	V _h Kaldırma Hızı Lifting Speeds <i>Vitesse de levage</i> [m/min]	Vinç Sınıfı Crane Class <i>Classification de l'application de levage</i> ISO (FEM)	P ₁ Motor Gücü Power <i>Puissance</i> [kW]	n ₂ Çıkış Devri Output Speeds <i>Vitesse de sortie</i> [r.p.m]	i Tahvil Ratio <i>Rapport de réduction</i>	M ₂ Çıkış Momenti Output Torque <i>Couple de sortie</i>	Tip Type <i>Typ</i>		 kg
Ø420	9,2	M8 (5m)	4	7,0	199,476	5203	IRCM 103 / 112 M 4b		
	10,4	M8 (5m)	5,5	7,9	177,284	6359	IRCM 103 / 132 S 4c		
	12,9	M8 (5m)	7,5	10	143,552	7021	IRCM 103 / 132 M 4b		
	15,8	M8 (5m)	7,5	12	119,126	5826	IRCM 103 / 132 M 4b		
	17,1	M8 (5m)	7,5	13	109,276	5345	IRCM 103 / 132 M 4b		
	19,8	M8 (5m)	9,2	15	95,896	5753	IRCM 103 / 132 M 4c		
	23,7	M8 (5m)	11	18	78,692	5645	IRCM 103 / 160 M 4b		
	25,1	M8 (5m)	11	19	71,869	5155	IRCM 103 / 160 M 4b		
	31,7	M8 (5m)	15	24	58,778	5750	IRCM 103 / 160 L 4a		
	35,6	M8 (5m)	18,5	27	51,907	6262	IRCM 103 / 180 M 4b		





D _T Tambur Çapı Drum Diameter <i>Diamètre de l'arbre</i> [mm]	V _h Kaldırma Hızı Lifting Speeds <i>Vitesse de levage</i> [m/min]	Vinç Sınıfı Crane Class <i>Classification de l'application de levage</i> ISO (FEM)	P ₁ Motor Gücü Power <i>Puissance</i> [kW]	n ₂ Çıkış Devri Output Speeds <i>Vitesse de sortie</i> [r.p.m]	i Tahvil Ratio <i>Rapport de réduction</i>	M ₂ Çıkış Momenti Output Torque <i>Couple de sortie</i>	Tip Type <i>Typ</i>		 kg
Ø170	2,3	M8 (5m)	1,1	8,6	162,826	1168	IRCM 93 / 90 S 4a		
	2,5	M8 (5m)	1,1	9,5	146,946	1054	IRCM 93 / 90 S 4a		
	2,7	M8 (5m)	1,5	10	133,419	1305	IRCM 93 / 90 L 4a		
	3,5	M8 (5m)	1,5	13	111,602	1092	IRCM 93 / 90 L 4a		
	4,3	M8 (5m)	2,2	16	87,936	1262	IRCM 93 / 100 L 4a		
	4,8	M8 (5m)	2,2	18	79,841	1145	IRCM 93 / 100 L 4a		
	5,6	M8 (5m)	3	21	66,785	1307	IRCM 93 / 100 L 4b		
	6,1	M8 (5m)	3	23	61,444	1202	IRCM 93 / 100 L 4b		
	6,9	M8 (5m)	3	26	54,545	1067	IRCM 93 / 100 L 4b		
	8,3	M8 (5m)	4	31	44,753	1167	IRCM 93 / 112 M 4b		
	10	M8 (5m)	5,5	38	37,199	1334	IRCM 93 / 132 S 4c		
	11	M8 (5m)	5,5	41	34,034	1221	IRCM 93 / 132 S 4c		
	12	M8 (5m)	5,5	45	31,194	1119	IRCM 93 / 132 S 4c		
	2,7	M8 (5m)	1,5	10	133,509	1306	IRCM 83 / 90 L 4a		
	3,2	M8 (5m)	1,5	12	121,711	1191	IRCM 83 / 90 L 4a		
	3,7	M8 (5m)	2,2	14	102,407	1469	IRCM 83 / 100 L 4a		
	4,0	M8 (5m)	2,2	15	92,330	1325	IRCM 83 / 100 L 4a		
	5,1	M7 (4m)	2,2	19	75,613	1085	IRCM 83 / 100 L 4a		
	6,1	M7 (4m)	3	23	60,299	1180	IRCM 83 / 100 L 4b		
	6,9	M7 (4m)	3	26	54,358	1063	IRCM 83 / 100 L 4b		
7,7	M7 (4m)	4	29	48,314	1260	IRCM 83 / 112 M 4b			
9,3	M7 (4m)	5,5	35	39,796	1427	IRCM 83 / 132 S 4c			
11	M7 (4m)	5,5	42	33,003	1184	IRCM 83 / 132 S 4c			
14	M7 (4m)	7,5	51	27,535	1347	IRCM 83 / 132 M 4b			
Ø180	2,4	M8 (5m)	1,1	8,6	162,826	1168	IRCM 93 / 90 S 4a		
	2,7	M8 (5m)	1,5	9,5	146,946	1437	IRCM 93 / 90 L 4a		
	2,8	M8 (5m)	1,5	10	133,419	1305	IRCM 93 / 90 L 4a		
	3,7	M8 (5m)	2,2	13	111,602	1601	IRCM 93 / 100 L 4a		
	4,5	M8 (5m)	2,2	16	87,936	1262	IRCM 93 / 100 L 4a		
	5,1	M8 (5m)	2,2	18	79,841	1145	IRCM 93 / 100 L 4a		
	5,9	M8 (5m)	3	21	66,785	1307	IRCM 93 / 100 L 4b		
	6,5	M8 (5m)	3	23	61,444	1202	IRCM 93 / 100 L 4b		
	7,3	M8 (5m)	4	26	54,545	1423	IRCM 93 / 112 M 4b		
	8,8	M8 (5m)	4	31	44,753	1167	IRCM 93 / 112 M 4b		
	11	M8 (5m)	5,5	38	37,199	1334	IRCM 93 / 132 S 4c		
	12	M8 (5m)	5,5	41	34,034	1221	IRCM 93 / 132 S 4c		
	13	M8 (5m)	5,5	45	31,194	1119	IRCM 93 / 132 S 4c		
	2,8	M8 (5m)	1,5	10	133,509	1306	IRCM 83 / 90 L 4a		
	3,4	M8 (5m)	1,5	12	121,711	1191	IRCM 83 / 90 L 4a		
	4,0	M8 (5m)	2,2	14	102,407	1469	IRCM 83 / 100 L 4a		
	4,2	M8 (5m)	2,2	15	92,330	1325	IRCM 83 / 100 L 4a		
	5,4	M8 (5m)	3	19	75,613	1479	IRCM 83 / 100 L 4b		
	6,5	M8 (5m)	3	23	60,299	1180	IRCM 83 / 100 L 4b		
	7,3	M8 (5m)	4	26	54,358	1418	IRCM 83 / 112 M 4b		
8,2	M8 (5m)	4	29	48,314	1260	IRCM 83 / 112 M 4b			
9,9	M8 (5m)	5,5	35	39,796	1427	IRCM 83 / 132 S 4c			
12	M8 (5m)	5,5	42	33,003	1184	IRCM 83 / 132 S 4c			
14	M8 (5m)	7,5	51	27,535	1347	IRCM 83 / 132 M 4b			



Vinç sistemleri kaldırma redüktörleri güç ve devir tabloları / Power and ratio table for hoisting applications / Tableau de classification des couples et rapports de réduction pour les applications de levage



D _T Tambur Çapı Drum Diameter Diamètre de l'arbre [mm]	V _h Kaldırma Hızı Lifting Speeds Vitesse de levage [m/min]	Vinç Sınıfı Crane Class Classification de l'application de levage ISO (FEM)	P ₁ Motor Gücü Power Puissance [kW]	n ₂ Çıkış Devri Output Speeds Vitesse de sortie [r.p.m]	i Tahvil Ratio Rapport de réduction	M ₂ Çıkış Momenti Output Torque Couple de sortie	Tip Type Typ		 kg
Ø190	2,6	M8 (5m)	1,5	8,6	162,826	1593	IRCM 93 / 90 L 4a		
	2,8	M8 (5m)	1,5	9,5	146,946	1437	IRCM 93 / 90 L 4a		
	3,0	M8 (5m)	1,5	10	133,419	1305	IRCM 93 / 90 L 4a		
	3,9	M8 (5m)	2,2	13	111,602	1601	IRCM 93 / 100 L 4a		
	4,8	M8 (5m)	2,2	16	87,936	1262	IRCM 93 / 100 L 4a		
	5,4	M8 (5m)	3	18	79,841	1562	IRCM 93 / 100 L 4b		
	6,3	M8 (5m)	3	21	66,785	1307	IRCM 93 / 100 L 4b		
	6,9	M8 (5m)	3	23	61,444	1202	IRCM 93 / 100 L 4b		
	7,8	M8 (5m)	4	26	54,545	1423	IRCM 93 / 112 M 4b		
	9,2	M8 (5m)	4	31	44,753	1167	IRCM 93 / 112 M 4b		
	11	M8 (5m)	5,5	38	37,199	1334	IRCM 93 / 132 S 4c		
	12	M8 (5m)	5,5	41	34,034	1221	IRCM 93 / 132 S 4c		
	13	M8 (5m)	7,5	45	31,194	1526	IRCM 93 / 132 M 4b		
	3,0	M7 (4m)	1,5	10	133,509	1306	IRCM 83 / 90 L 4a		
	3,6	M7 (4m)	2,2	12	121,711	1746	IRCM 83 / 100 L 4a		
	4,2	M7 (4m)	2,2	14	102,407	1469	IRCM 83 / 100 L 4a		
	4,5	M7 (4m)	2,2	15	92,330	1325	IRCM 83 / 100 L 4a		
	5,7	M7 (4m)	3	19	75,613	1479	IRCM 83 / 100 L 4b		
	6,9	M7 (4m)	3	23	60,299	1180	IRCM 83 / 100 L 4b		
	7,8	M7 (4m)	4	26	54,358	1418	IRCM 83 / 112 M 4b		
8,7	M7 (4m)	4	29	48,314	1260	IRCM 83 / 112 M 4b			
10	M7 (4m)	5,5	35	39,796	1427	IRCM 83 / 132 S 4c			
13	M7 (4m)	5,5	42	33,003	1184	IRCM 83 / 132 S 4c			
15	M6 (3m)	7,5	51	27,535	1347	IRCM 83 / 132 M 4b			
Ø200	2,7	M8 (5m)	1,5	8,6	162,826	1593	IRCM 93 / 90 L 4a		
	3,0	M8 (5m)	1,5	9,5	146,946	1437	IRCM 93 / 90 L 4a		
	3,1	M8 (5m)	1,5	10	133,419	1305	IRCM 93 / 90 L 4a		
	4,1	M8 (5m)	2,2	13	111,602	1601	IRCM 93 / 100 L 4a		
	5,0	M8 (5m)	2,2	16	87,936	1262	IRCM 93 / 100 L 4a		
	5,7	M8 (5m)	3	18	79,841	1562	IRCM 93 / 100 L 4b		
	6,6	M8 (5m)	3	21	66,785	1307	IRCM 93 / 100 L 4b		
	7,2	M8 (5m)	4	23	61,444	1603	IRCM 93 / 112 M 4b		
	8,2	M8 (5m)	4	26	54,545	1423	IRCM 93 / 112 M 4b		
	9,7	M8 (5m)	5,5	31	44,753	1605	IRCM 93 / 132 S 4c		
	12	M8 (5m)	5,5	38	37,199	1334	IRCM 93 / 132 S 4c		
	13	M8 (5m)	7,5	41	34,034	1665	IRCM 93 / 132 M 4b		
	14	M8 (5m)	7,5	45	31,194	1526	IRCM 93 / 132 M 4b		
	3,1	M7 (4m)	1,5	10	133,509	1306	IRCM 83 / 90 L 4a		
	3,8	M7 (4m)	2,2	12	121,711	1746	IRCM 83 / 100 L 4a		
	4,4	M7 (4m)	2,2	14	102,407	1469	IRCM 83 / 100 L 4a		
	4,7	M7 (4m)	2,2	15	92,330	1325	IRCM 83 / 100 L 4a		
	6,0	M7 (4m)	3	19	75,613	1479	IRCM 83 / 100 L 4b		
	7,2	M7 (4m)	4	23	60,299	1573	IRCM 83 / 112 M 4b		
	8,2	M7 (4m)	4	26	54,358	1418	IRCM 83 / 112 M 4b		
9,1	M7 (4m)	4	29	48,314	1260	IRCM 83 / 112 M 4b			
11	M6 (3m)	5,5	35	39,796	1427	IRCM 83 / 132 S 4c			
13	M6 (3m)	7,5	42	33,003	1614	IRCM 83 / 132 M 4b			
16	M6 (3m)	7,5	51	27,535	1347	IRCM 83 / 132 M 4b			





D _T Tambur Çapı Drum Diameter <i>Diamètre de l'arbre</i> [mm]	V _h Kaldırma Hızı Lifting Speeds <i>Vitesse de levage</i> [m/min]	Vinç Sınıfı Crane Class <i>Classification de l'application de levage</i> ISO (FEM)	P ₁ Motor Gücü Power <i>Puissance</i> [kW]	n ₂ Çıkış Devri Output Speeds <i>Vitesse de sortie</i> [r.p.m]	i Tahvil Ratio <i>Rapport de réduction</i>	M ₂ Çıkış Momenti Output Torque <i>Couple de sortie</i>	Tip Type <i>Typ</i>		 kg
Ø210	2,8	M8 (5m)	1,5	8,6	162,826	1593	IRCM 93 / 90 L 4a		
	3,1	M8 (5m)	1,5	9,5	146,946	1437	IRCM 93 / 90 L 4a		
	3,3	M8 (5m)	1,5	10	133,419	1305	IRCM 93 / 90 L 4a		
	4,3	M8 (5m)	2,2	13	111,602	1601	IRCM 93 / 100 L 4a		
	5,3	M8 (5m)	3	16	87,936	1720	IRCM 93 / 100 L 4b		
	5,9	M8 (5m)	3	18	79,841	1562	IRCM 93 / 100 L 4b		
	6,9	M8 (5m)	3	21	66,785	1307	IRCM 93 / 100 L 4b		
	7,6	M8 (5m)	4	23	61,444	1603	IRCM 93 / 112 M 4b		
	8,6	M8 (5m)	4	26	54,545	1423	IRCM 93 / 112 M 4b		
	10	M8 (5m)	5,5	31	44,753	1605	IRCM 93 / 132 S 4c		
	13	M8 (5m)	5,5	38	37,199	1334	IRCM 93 / 132 S 4c		
	14	M8 (5m)	7,5	41	34,034	1665	IRCM 93 / 132 M 4b		
	15	M8 (5m)	7,5	45	31,194	1526	IRCM 93 / 132 M 4b		
	3,3	M7 (4m)	1,5	10	133,509	1306	IRCM 83 / 90 L 4a		
	4,0	M7 (4m)	2,2	12	121,711	1746	IRCM 83 / 100 L 4a		
	4,6	M7 (4m)	2,2	14	102,407	1469	IRCM 83 / 100 L 4a		
	4,9	M7 (4m)	2,2	15	92,330	1325	IRCM 83 / 100 L 4a		
	6,3	M7 (4m)	3	19	75,613	1479	IRCM 83 / 100 L 4b		
	7,6	M7 (4m)	4	23	60,299	1573	IRCM 83 / 112 M 4b		
	8,6	M7 (4m)	4	26	54,358	1418	IRCM 83 / 112 M 4b		
9,6	M6 (3m)	5,5	29	48,314	1733	IRCM 83 / 132 S 4c			
12	M6 (3m)	5,5	35	39,796	1427	IRCM 83 / 132 S 4c			
14	M6 (3m)	7,5	42	33,003	1614	IRCM 83 / 132 M 4b			
17	M6 (3m)	7,5	51	27,535	1347	IRCM 83 / 132 M 4b			
Ø220	3,0	M8 (5m)	1,5	8,6	162,826	1593	IRCM 93 / 90 L 4a		
	3,3	M8 (5m)	1,5	9,5	146,946	1437	IRCM 93 / 90 L 4a		
	3,5	M8 (5m)	1,5	10	133,419	1305	IRCM 93 / 90 L 4a		
	4,5	M8 (5m)	2,2	13	111,602	1601	IRCM 93 / 100 L 4a		
	5,5	M8 (5m)	3	16	87,936	1720	IRCM 93 / 100 L 4b		
	6,2	M8 (5m)	3	18	79,841	1562	IRCM 93 / 100 L 4b		
	7,3	M8 (5m)	4	21	66,785	1742	IRCM 93 / 112 M 4b		
	7,9	M8 (5m)	4	23	61,444	1603	IRCM 93 / 112 M 4b		
	9,0	M8 (5m)	4	26	54,545	1423	IRCM 93 / 112 M 4b		
	11	M8 (5m)	5,5	31	44,753	1605	IRCM 93 / 132 S 4c		
	13	M8 (5m)	7,5	38	37,199	1819	IRCM 93 / 132 M 4b		
	14	M8 (5m)	7,5	41	34,034	1665	IRCM 93 / 132 M 4b		
	16	M8 (5m)	7,5	45	31,194	1526	IRCM 93 / 132 M 4b		
	3,5	M7 (4m)	1,5	10	133,509	1306	IRCM 83 / 90 L 4a		
	4,1	M7 (4m)	2,2	12	121,711	1746	IRCM 83 / 100 L 4a		
	4,8	M7 (4m)	2,2	14	102,407	1469	IRCM 83 / 100 L 4a		
	5,2	M7 (4m)	3	15	92,330	1806	IRCM 83 / 100 L 4b		
	6,6	M7 (4m)	3	19	75,613	1479	IRCM 83 / 100 L 4b		
	7,9	M7 (4m)	4	23	60,299	1573	IRCM 83 / 112 M 4b		
	9,0	M6 (3m)	4	26	54,358	1418	IRCM 83 / 112 M 4b		
10	M6 (3m)	5,5	29	48,314	1733	IRCM 83 / 132 S 4c			
12	M6 (3m)	5,5	35	39,796	1427	IRCM 83 / 132 S 4c			
15	M6 (3m)	7,5	42	33,003	1614	IRCM 83 / 132 M 4b			
18	M6 (3m)	9,2	51	27,535	1652	IRCM 83 / 132 M 4c			



Vinç sistemleri kaldırma redüktörleri güç ve devir tabloları / Power and ratio table for hoisting applications / Tableau de classification des couples et rapports de réduction pour les applications de levage



D _T Tambur Çapı Drum Diameter Diamètre de l'arbre [mm]	V _h Kaldırma Hızı Lifting Speeds Vitesse de levage [m/min]	Vinç Sınıfı Crane Class Classification de l'application de levage ISO (FEM)	P ₁ Motor Gücü Power Puissance [kW]	n ₂ Çıkış Devri Output Speeds Vitesse de sortie [r.p.m]	i Tahvil Ratio Rapport de réduction	M ₂ Çıkış Momenti Output Torque Couple de sortie	Tip Type Typ		 kg
Ø230	3,1	M8 (5m)	1,5	8,6	162,826	1593	IRCM 93 / 90 L 4a		
	3,4	M8 (5m)	1,5	9,5	146,946	1437	IRCM 93 / 90 L 4a		
	3,6	M8 (5m)	2,2	10	133,419	1914	IRCM 93 / 100 L 4a		
	4,7	M8 (5m)	2,2	13	111,602	1601	IRCM 93 / 100 L 4a		
	5,8	M8 (5m)	3	16	87,936	1720	IRCM 93 / 100 L 4b		
	6,5	M8 (5m)	3	18	79,841	1562	IRCM 93 / 100 L 4b		
	7,6	M8 (5m)	4	21	66,785	1742	IRCM 93 / 112 M 4b		
	8,3	M8 (5m)	4	23	61,444	1603	IRCM 93 / 112 M 4b		
	9,4	M8 (5m)	5,5	26	54,545	1956	IRCM 93 / 132 S 4c		
	11	M8 (5m)	5,5	31	44,753	1605	IRCM 93 / 132 S 4c		
	14	M8 (5m)	7,5	38	37,199	1819	IRCM 93 / 132 M 4b		
	15	M8 (5m)	7,5	41	34,034	1665	IRCM 93 / 132 M 4b		
	16	M8 (5m)	7,5	45	31,194	1526	IRCM 93 / 132 M 4b		
	3,6	M6 (3m)	2,2	10	133,509	1915	IRCM 83 / 100 L 4a		
	4,3	M6 (3m)	2,2	12	121,711	1746	IRCM 83 / 100 L 4a		
	5,1	M6 (3m)	2,2	14	102,407	1469	IRCM 83 / 100 L 4a		
	5,4	M6 (3m)	3	15	92,330	1806	IRCM 83 / 100 L 4b		
	6,9	M6 (3m)	3	19	75,613	1479	IRCM 83 / 100 L 4b		
	8,3	M6 (3m)	4	23	60,299	1573	IRCM 83 / 112 M 4b		
	9,4	M6 (3m)	5,5	26	54,358	1950	IRCM 83 / 132 S 4c		
10	M6 (3m)	5,5	29	48,314	1733	IRCM 83 / 132 S 4c			
13	M6 (3m)	5,5	35	39,796	1427	IRCM 83 / 132 S 4c			
15	M6 (3m)	7,5	42	33,003	1614	IRCM 83 / 132 M 4b			
18	M5 (2m)	9,2	51	27,535	1652	IRCM 83 / 132 M 4c			
Ø240	3,2	M8 (5m)	1,5	8,6	162,826	1593	IRCM 93 / 90 L 4a		
	3,6	M8 (5m)	2,2	9,5	146,946	2108	IRCM 93 / 100 L 4a		
	3,8	M8 (5m)	2,2	10	133,419	1914	IRCM 93 / 100 L 4a		
	4,9	M8 (5m)	2,2	13	111,602	1601	IRCM 93 / 100 L 4a		
	6,0	M8 (5m)	3	16	87,936	1720	IRCM 93 / 100 L 4b		
	6,8	M8 (5m)	3	18	79,841	1562	IRCM 93 / 100 L 4b		
	7,9	M8 (5m)	4	21	66,785	1742	IRCM 93 / 112 M 4b		
	8,7	M8 (5m)	4	23	61,444	1603	IRCM 93 / 112 M 4b		
	9,8	M8 (5m)	5,5	26	54,545	1956	IRCM 93 / 132 S 4c		
	12	M8 (5m)	5,5	31	44,753	1605	IRCM 93 / 132 S 4c		
	14	M8 (5m)	7,5	38	37,199	1819	IRCM 93 / 132 M 4b		
	15	M8 (5m)	7,5	41	34,034	1665	IRCM 93 / 132 M 4b		
	17	M8 (5m)	7,5	45	31,194	1526	IRCM 93 / 132 M 4b		
	3,8	M6 (3m)	2,2	10	133,509	1915	IRCM 83 / 100 L 4a		
	4,5	M6 (3m)	2,2	12	121,711	1746	IRCM 83 / 100 L 4a		
	5,3	M6 (3m)	3	14	102,407	2003	IRCM 83 / 100 L 4b		
	5,7	M6 (3m)	3	15	92,330	1806	IRCM 83 / 100 L 4b		
	7,2	M6 (3m)	4	19	75,613	1972	IRCM 83 / 112 M 4b		
	8,7	M6 (3m)	4	23	60,299	1573	IRCM 83 / 112 M 4b		
	9,8	M6 (3m)	5,5	26	54,358	1950	IRCM 83 / 132 S 4c		
11	M6 (3m)	5,5	29	48,314	1733	IRCM 83 / 132 S 4c			
13	M6 (3m)	7,5	35	39,796	1946	IRCM 83 / 132 M 4b			
16	M5 (2m)	7,5	42	33,003	1614	IRCM 83 / 132 M 4b			
19	M5 (2m)	9,2	51	27,535	1652	IRCM 83 / 132 M 4c			





D _T Tambur Çapı Drum Diameter <i>Diamètre de l'arbre</i> [mm]	V _h Kaldırma Hızı Lifting Speeds <i>Vitesse de levage</i> [m/min]	Vinç Sınıfı Crane Class <i>Classification de l'application de levage</i> ISO (FEM)	P ₁ Motor Gücü Power <i>Puissance</i> [kW]	n ₂ Çıkış Devri Output Speeds <i>Vitesse de sortie</i> [r.p.m]	i Tahvil Ratio <i>Rapport de réduction</i>	M ₂ Çıkış Momenti Output Torque <i>Couple de sortie</i>	Tip Type <i>Typ</i>		 kg
Ø110	1,0	M8 (5m)	0,55	12	120,792	433	IRCM 73 / 80 M 4a		
	1,1	M8 (5m)	0,55	13	107,423	385	IRCM 73 / 80 M 4a		
	1,3	M8 (5m)	0,75	15	96,194	470	IRCM 73 / 80 M 4b		
	1,4	M8 (5m)	0,75	16	86,628	424	IRCM 73 / 80 M 4b		
	1,6	M8 (5m)	0,75	19	73,889	361	IRCM 73 / 80 M 4b		
	1,8	M8 (5m)	1,1	21	65,252	468	IRCM 73 / 90 S 4a		
	2,1	M8 (5m)	1,1	24	57,996	416	IRCM 73 / 90 S 4a		
	2,3	M8 (5m)	1,1	27	51,846	372	IRCM 73 / 90 S 4a		
	2,8	M8 (5m)	1,5	33	41,848	409	IRCM 73 / 90 L 4a		
	3,4	M8 (5m)	1,5	39	35,564	348	IRCM 73 / 90 L 4a		
	3,8	M8 (5m)	2,2	44	32,098	461	IRCM 73 / 100 L 4a		
	4,6	M8 (5m)	2,2	53	26,291	377	IRCM 73 / 100 L 4a		
	5,1	M8 (5m)	2,2	59	23,834	342	IRCM 73 / 100 L 4a		
Ø120	1,1	M8 (5m)	0,55	12	120,792	433	IRCM 73 / 80 M 4a		
	1,2	M8 (5m)	0,55	13	107,423	385	IRCM 73 / 80 M 4a		
	1,4	M8 (5m)	0,75	15	96,194	470	IRCM 73 / 80 M 4b		
	1,5	M8 (5m)	0,75	16	86,628	424	IRCM 73 / 80 M 4b		
	1,8	M8 (5m)	1,1	19	73,889	530	IRCM 73 / 90 S 4a		
	2,0	M8 (5m)	1,1	21	65,252	468	IRCM 73 / 90 S 4a		
	2,3	M8 (5m)	1,1	24	57,996	416	IRCM 73 / 90 S 4a		
	2,5	M8 (5m)	1,1	27	51,846	372	IRCM 73 / 90 S 4a		
	3,1	M8 (5m)	1,5	33	41,848	409	IRCM 73 / 90 L 4a		
	3,7	M8 (5m)	2,2	39	35,564	510	IRCM 73 / 100 L 4a		
	4,1	M8 (5m)	2,2	44	32,098	461	IRCM 73 / 100 L 4a		
	5,0	M8 (5m)	2,2	53	26,291	377	IRCM 73 / 100 L 4a		
	5,6	M8 (5m)	3	59	23,834	466	IRCM 73 / 100 L 4b		
Ø130	1,2	M8 (5m)	0,55	12	120,792	433	IRCM 73 / 80 M 4a		
	1,3	M8 (5m)	0,75	13	107,423	525	IRCM 73 / 80 M 4b		
	1,5	M8 (5m)	0,75	15	96,194	470	IRCM 73 / 80 M 4b		
	1,6	M8 (5m)	0,75	16	86,628	424	IRCM 73 / 80 M 4b		
	1,9	M8 (5m)	1,1	19	73,889	530	IRCM 73 / 90 S 4a		
	2,1	M8 (5m)	1,1	21	65,252	468	IRCM 73 / 90 S 4a		
	2,4	M8 (5m)	1,1	24	57,996	416	IRCM 73 / 90 S 4a		
	2,8	M8 (5m)	1,5	27	51,846	507	IRCM 73 / 90 L 4a		
	3,4	M8 (5m)	1,5	33	41,848	409	IRCM 73 / 90 L 4a		
	4,0	M8 (5m)	2,2	39	35,564	510	IRCM 73 / 100 L 4a		
	4,5	M8 (5m)	2,2	44	32,098	461	IRCM 73 / 100 L 4a		
	5,4	M8 (5m)	3	53	26,291	514	IRCM 73 / 100 L 4b		
	6,0	M8 (5m)	3	59	23,834	466	IRCM 73 / 100 L 4b		
Ø140	1,3	M8 (5m)	0,75	12	120,792	591	IRCM 73 / 80 M 4b		
	1,4	M8 (5m)	0,75	13	107,423	525	IRCM 73 / 80 M 4b		
	1,6	M8 (5m)	0,75	15	96,194	470	IRCM 73 / 80 M 4b		
	1,8	M8 (5m)	1,1	16	86,628	621	IRCM 73 / 90 S 4a		
	2,1	M8 (5m)	1,1	19	73,889	530	IRCM 73 / 90 S 4a		
	2,3	M8 (5m)	1,1	21	65,252	468	IRCM 73 / 90 S 4a		
	2,6	M8 (5m)	1,5	24	57,996	567	IRCM 73 / 90 L 4a		
	3,0	M8 (5m)	1,5	27	51,846	507	IRCM 73 / 90 L 4a		
	3,6	M8 (5m)	2,2	33	41,848	600	IRCM 73 / 100 L 4a		
	4,3	M8 (5m)	2,2	39	35,564	510	IRCM 73 / 100 L 4a		
	4,8	M8 (5m)	2,2	44	32,098	461	IRCM 73 / 100 L 4a		
	5,8	M8 (5m)	3	53	26,291	514	IRCM 73 / 100 L 4b		
	6,5	M8 (5m)	3	59	23,834	466	IRCM 73 / 100 L 4b		



Vinç sistemleri kaldırma redüktörleri güç ve devir tabloları / Power and ratio table for hoisting applications / Tableau de classification des couples et rapports de réduction pour les applications de levage



D _T Tambur Çapı Drum Diameter <i>Diamètre de l'arbre</i> [mm]	V _h Kaldırma Hızı Lifting Speeds <i>Vitesse de levage</i> [m/min]	Vinç Sınıfı Crane Class <i>Classification de l'application de levage</i> ISO (FEM)	P ₁ Motor Gücü Power <i>Puissance</i> [kW]	n ₂ Çıkış Devri Output Speeds <i>Vitesse de sortie</i> [r.p.m]	i Tahvil Ratio <i>Rapport de réduction</i>	M ₂ Çıkış Momenti Output Torque <i>Couple de sortie</i>	Tip Type <i>Typ</i>		 kg
Ø150	1,4	M8 (5m)	0,75	12	120,792	591	IRCM 73 / 80 M 4b		
	1,5	M8 (5m)	0,75	13	107,423	525	IRCM 73 / 80 M 4b		
	1,8	M8 (5m)	1,1	15	96,194	690	IRCM 73 / 90 S 4a		
	1,9	M8 (5m)	1,1	16	86,628	621	IRCM 73 / 90 S 4a		
	2,2	M8 (5m)	1,1	19	73,889	530	IRCM 73 / 90 S 4a		
	2,5	M8 (5m)	1,1	21	65,252	468	IRCM 73 / 90 S 4a		
	2,8	M8 (5m)	1,5	24	57,996	567	IRCM 73 / 90 L 4a		
	3,2	M8 (5m)	1,5	27	51,846	507	IRCM 73 / 90 L 4a		
	3,9	M8 (5m)	2,2	33	41,848	600	IRCM 73 / 100 L 4a		
	4,6	M8 (5m)	2,2	39	35,564	510	IRCM 73 / 100 L 4a		
	5,2	M8 (5m)	3	44	32,098	628	IRCM 73 / 100 L 4b		
	6,2	M8 (5m)	3	53	26,291	514	IRCM 73 / 100 L 4b		
Ø160	6,9	M8 (5m)	3	59	23,834	466	IRCM 73 / 100 L 4b		
	1,5	M8 (5m)	0,75	12	120,792	591	IRCM 73 / 80 M 4b		
	1,6	M8 (5m)	0,75	13	107,423	525	IRCM 73 / 80 M 4b		
	1,9	M8 (5m)	1,1	15	96,194	690	IRCM 73 / 90 S 4a		
	2,0	M8 (5m)	1,1	16	86,628	621	IRCM 73 / 90 S 4a		
	2,4	M8 (5m)	1,1	19	73,889	530	IRCM 73 / 90 S 4a		
	2,6	M8 (5m)	1,5	21	65,252	638	IRCM 73 / 90 L 4a		
	3,0	M8 (5m)	1,5	24	57,996	567	IRCM 73 / 90 L 4a		
	3,4	M8 (5m)	1,5	27	51,846	507	IRCM 73 / 90 L 4a		
	4,1	M8 (5m)	2,2	33	41,848	600	IRCM 73 / 100 L 4a		
	4,9	M8 (5m)	2,2	39	35,564	510	IRCM 73 / 100 L 4a		
	5,5	M8 (5m)	3	44	32,098	628	IRCM 73 / 100 L 4b		
Ø170	6,7	M7 (4m)	3	53	26,291	514	IRCM 73 / 100 L 4b		
	7,4	M7 (4m)	4	59	23,834	622	IRCM 73 / 112 M 4b		
	1,6	M8 (5m)	0,75	12	120,792	591	IRCM 73 / 80 M 4b		
	1,7	M8 (5m)	0,75	13	107,423	525	IRCM 73 / 80 M 4b		
	2,0	M8 (5m)	1,1	15	96,194	690	IRCM 73 / 90 S 4a		
	2,1	M8 (5m)	1,1	16	86,628	621	IRCM 73 / 90 S 4a		
	2,5	M8 (5m)	1,1	19	73,889	530	IRCM 73 / 90 S 4a		
	2,8	M8 (5m)	1,5	21	65,252	638	IRCM 73 / 90 L 4a		
	3,2	M8 (5m)	1,5	24	57,996	567	IRCM 73 / 90 L 4a		
	3,6	M8 (5m)	2,2	27	51,846	744	IRCM 73 / 100 L 4a		
	4,4	M8 (5m)	2,2	33	41,848	600	IRCM 73 / 100 L 4a		
	5,2	M7 (4m)	3	39	35,564	696	IRCM 73 / 100 L 4b		
Ø180	5,9	M7 (4m)	3	44	32,098	628	IRCM 73 / 100 L 4b		
	7,1	M7 (4m)	4	53	26,291	686	IRCM 73 / 112 M 4b		
	7,9	M7 (4m)	4	59	23,834	622	IRCM 73 / 112 M 4b		
	1,7	M8 (5m)	0,75	12	120,792	591	IRCM 73 / 80 M 4b		
	1,8	M8 (5m)	1,1	13	107,423	771	IRCM 73 / 90 S 4a		
	2,1	M7 (4m)	1,1	15	96,194	690	IRCM 73 / 90 S 4a		
	2,3	M7 (4m)	1,1	16	86,628	621	IRCM 73 / 90 S 4a		
	2,7	M7 (4m)	1,5	19	73,889	723	IRCM 73 / 90 L 4a		
	3,0	M7 (4m)	1,5	21	65,252	638	IRCM 73 / 90 L 4a		
	3,4	M7 (4m)	1,5	24	57,996	567	IRCM 73 / 90 L 4a		
	3,8	M7 (4m)	2,2	27	51,846	744	IRCM 73 / 100 L 4a		
	4,7	M7 (4m)	2,2	33	41,848	600	IRCM 73 / 100 L 4a		
5,5	M7 (4m)	3	39	35,564	696	IRCM 73 / 100 L 4b			
6,2	M7 (4m)	3	44	32,098	628	IRCM 73 / 100 L 4b			
7,5	M7 (4m)	4	53	26,291	686	IRCM 73 / 112 M 4b			
8,3	M7 (4m)	4	59	23,834	622	IRCM 73 / 112 M 4b			



D _T Tambur Çapı Drum Diameter <i>Diamètre de l'arbre</i> [mm]	V _h Kaldırma Hızı Lifting Speeds <i>Vitesse de levage</i> [m/min]	Vinç Sınıfı Crane Class <i>Classification de l'application de levage</i> ISO (FEM)	P ₁ Motor Gücü Power <i>Puissance</i> [kW]	n ₂ Çıkış Devri Output Speeds <i>Vitesse de sortie</i> [r.p.m]	i Tahvil Ratio <i>Rapport de réduction</i>	M ₂ Çıkış Momenti Output Torque <i>Couple de sortie</i>	Tip Type <i>Typ</i>		 kg
Ø270	5,9	M8 (5m)	4	7,0	199,476	5203	IRCM 103 / 112 M 4b		
	6,7	M8 (5m)	4	7,9	177,284	4624	IRCM 103 / 112 M 4b		
	8,3	M8 (5m)	5,5	10	143,552	5149	IRCM 103 / 132 S 4c		
	10,2	M8 (5m)	7,5	12	119,126	5826	IRCM 103 / 132 M 4b		
	11,0	M8 (5m)	7,5	13	109,276	5345	IRCM 103 / 132 M 4b		
	12,7	M8 (5m)	7,5	15	95,896	4690	IRCM 103 / 132 M 4b		
	15,3	M8 (5m)	9,2	18	78,692	4721	IRCM 103 / 132 M 4c		
	16,1	M8 (5m)	9,2	19	71,869	4312	IRCM 103 / 132 M 4c		
	20,3	M8 (5m)	15	24	58,778	5750	IRCM 103 / 160 L 4a		
	22,9	M8 (5m)	15	27	51,907	5078	IRCM 103 / 160 L 4a		
	7,3	M5 (2m)	5,5	8,6	162,826	5840	IRCM 93 / 132 S 4c		
	8,1	M5 (2m)	5,5	9,5	146,946	5271	IRCM 93 / 132 S 4c		
	8,5	M5 (2m)	5,5	10	133,419	4785	IRCM 93 / 132 S 4c		
	11	M5 (2m)	7,5	13	111,602	5458	IRCM 93 / 132 M 4b		
	14	M4 (1Am)	7,5	16	87,936	4301	IRCM 93 / 132 M 4b		
	15	M4 (1Am)	9,2	18	79,841	4790	IRCM 93 / 132 M 4c		
	18	M4 (1Am)	11	21	66,785	4791	IRCM 93 / 160 M 4b		
	19	M4 (1Am)	11	23	61,444	4408	IRCM 93 / 160 M 4b		
	22	M4 (1Am)	15	26	54,545	5336	IRCM 93 / 160 L 4a		
26	M3 (1Bm)	15	31	44,753	4378	IRCM 93 / 160 L 4a			
Ø280	6,2	M8 (5m)	4	7,0	199,476	5203	IRCM 103 / 112 M 4b		
	6,9	M8 (5m)	4	7,9	177,284	4624	IRCM 103 / 112 M 4b		
	8,6	M8 (5m)	5,5	10	143,552	5149	IRCM 103 / 132 S 4c		
	10,6	M8 (5m)	7,5	12	119,126	5826	IRCM 103 / 132 M 4b		
	11,4	M8 (5m)	7,5	13	109,276	5345	IRCM 103 / 132 M 4b		
	13,2	M8 (5m)	7,5	15	95,896	4690	IRCM 103 / 132 M 4b		
	15,8	M8 (5m)	9,2	18	78,692	4721	IRCM 103 / 132 M 4c		
	16,7	M8 (5m)	9,2	19	71,869	4312	IRCM 103 / 132 M 4c		
	21,1	M8 (5m)	15	24	58,778	5750	IRCM 103 / 160 L 4a		
	23,7	M8 (5m)	15	27	51,907	5078	IRCM 103 / 160 L 4a		
	7,6	M5 (2m)	5,5	8,6	162,826	5840	IRCM 93 / 132 S 4c		
	8,4	M5 (2m)	5,5	9,5	146,946	5271	IRCM 93 / 132 S 4c		
	8,8	M5 (2m)	5,5	10	133,419	4785	IRCM 93 / 132 S 4c		
	11	M4 (1Am)	7,5	13	111,602	5458	IRCM 93 / 132 M 4b		
	14	M4 (1Am)	9,2	16	87,936	5276	IRCM 93 / 132 M 4c		
	16	M4 (1Am)	9,2	18	79,841	4790	IRCM 93 / 132 M 4c		
	18	M4 (1Am)	11	21	66,785	4791	IRCM 93 / 160 M 4b		
	20	M4 (1Am)	15	23	61,444	6010	IRCM 93 / 160 L 4a		
	23	M3 (1Bm)	15	26	54,545	5336	IRCM 93 / 160 L 4a		
Ø290	6,4	M8 (5m)	4	7,0	199,476	5203	IRCM 103 / 112 M 4b		
	7,2	M8 (5m)	4	7,9	177,284	4624	IRCM 103 / 112 M 4b		
	8,9	M8 (5m)	5,5	10	143,552	5149	IRCM 103 / 132 S 4c		
	10,9	M8 (5m)	7,5	12	119,126	5826	IRCM 103 / 132 M 4b		
	11,8	M8 (5m)	7,5	13	109,276	5345	IRCM 103 / 132 M 4b		
	13,7	M8 (5m)	9,2	15	95,896	5753	IRCM 103 / 132 M 4c		
	16,4	M8 (5m)	9,2	18	78,692	4721	IRCM 103 / 132 M 4c		
	17,3	M8 (5m)	11	19	71,869	5155	IRCM 103 / 160 M 4b		
	21,9	M8 (5m)	15	24	58,778	5750	IRCM 103 / 160 L 4a		
	24,6	M8 (5m)	15	27	51,907	5078	IRCM 103 / 160 L 4a		



Vinç sistemleri kaldırma redüktörleri güç ve devir tabloları / Power and ratio table for hoisting applications / Tableau de classification des couples et rapports de réduction pour les applications de levage

D _T Tambur Çapı Drum Diameter <i>Diamètre de l'arbre</i> [mm]	V _h Kaldırma Hızı Lifting Speeds <i>Vitesse de levage</i> [m/min]	Vinç Sınıfı Crane Class <i>Classification de l'application de levage</i> ISO (FEM)	P ₁ Motor Gücü Power <i>Puissance</i> [kW]	n ₂ Çıkış Devri Output Speeds <i>Vitesse de sortie</i> [r.p.m]	i Tahvil Ratio <i>Rapport de réduction</i>	M ₂ Çıkış Momenti Output Torque <i>Couple de sortie</i>	Tip Type <i>Typ</i>		 kg
Ø300	6,6	M8 (5m)	4	7,0	199,476	5203	IRCM 103 / 112 M 4b		
	7,4	M8 (5m)	5,5	7,9	177,284	6359	IRCM 103 / 132 S 4c		
	9,2	M8 (5m)	5,5	10	143,552	5149	IRCM 103 / 132 S 4c		
	11,3	M8 (5m)	7,5	12	119,126	5826	IRCM 103 / 132 M 4b		
	12,2	M8 (5m)	7,5	13	109,276	5345	IRCM 103 / 132 M 4b		
	14,1	M8 (5m)	9,2	15	95,896	5753	IRCM 103 / 132 M 4c		
	17,0	M8 (5m)	11	18	78,692	5645	IRCM 103 / 160 M 4b		
	17,9	M8 (5m)	11	19	71,869	5155	IRCM 103 / 160 M 4b		
	22,6	M8 (5m)	15	24	58,778	5750	IRCM 103 / 160 L 4a		
25,4	M8 (5m)	15	27	51,907	5078	IRCM 103 / 160 L 4a			
Ø310	6,8	M8 (5m)	4	7,0	199,476	5203	IRCM 103 / 112 M 4b		
	7,7	M8 (5m)	5,5	7,9	177,284	6359	IRCM 103 / 132 S 4c		
	9,5	M8 (5m)	5,5	10	143,552	5149	IRCM 103 / 132 S 4c		
	11,7	M8 (5m)	7,5	12	119,126	5826	IRCM 103 / 132 M 4b		
	12,7	M8 (5m)	7,5	13	109,276	5345	IRCM 103 / 132 M 4b		
	14,6	M8 (5m)	9,2	15	95,896	5753	IRCM 103 / 132 M 4c		
	17,5	M8 (5m)	11	18	78,692	5645	IRCM 103 / 160 M 4b		
	18,5	M8 (5m)	11	19	71,869	5155	IRCM 103 / 160 M 4b		
	23,4	M8 (5m)	15	24	58,778	5750	IRCM 103 / 160 L 4a		
26,3	M7 (4m)	15	27	51,907	5078	IRCM 103 / 160 L 4a			
Ø320	7,0	M8 (5m)	4	7,0	199,476	5203	IRCM 103 / 112 M 4b		
	7,9	M8 (5m)	5,5	7,9	177,284	6359	IRCM 103 / 132 S 4c		
	9,8	M8 (5m)	5,5	10	143,552	5149	IRCM 103 / 132 S 4c		
	12,1	M8 (5m)	7,5	12	119,126	5826	IRCM 103 / 132 M 4b		
	13,1	M8 (5m)	7,5	13	109,276	5345	IRCM 103 / 132 M 4b		
	15,1	M8 (5m)	9,2	15	95,896	5753	IRCM 103 / 132 M 4c		
	18,1	M8 (5m)	11	18	78,692	5645	IRCM 103 / 160 M 4b		
	19,1	M8 (5m)	11	19	71,869	5155	IRCM 103 / 160 M 4b		
	24,1	M8 (5m)	15	24	58,778	5750	IRCM 103 / 160 L 4a		
27,1	M7 (4m)	15	27	51,907	5078	IRCM 103 / 160 L 4a			
Ø330	7,3	M8 (5m)	4	7,0	199,476	5203	IRCM 103 / 112 M 4b		
	8,2	M8 (5m)	5,5	7,9	177,284	6359	IRCM 103 / 132 S 4c		
	10,2	M8 (5m)	7,5	10	143,552	7021	IRCM 103 / 132 M 4b		
	12,4	M8 (5m)	7,5	12	119,126	5826	IRCM 103 / 132 M 4b		
	13,5	M8 (5m)	7,5	13	109,276	5345	IRCM 103 / 132 M 4b		
	15,5	M8 (5m)	9,2	15	95,896	5753	IRCM 103 / 132 M 4c		
	18,7	M8 (5m)	11	18	78,692	5645	IRCM 103 / 160 M 4b		
	19,7	M8 (5m)	11	19	71,869	5155	IRCM 103 / 160 M 4b		
	24,9	M7 (4m)	15	24	58,778	5750	IRCM 103 / 160 L 4a		
28,0	M7 (4m)	18,5	27	51,907	6262	IRCM 103 / 180 M 4b			
Ø340	7,5	M8 (5m)	5,5	7,0	199,476	7155	IRCM 103 / 132 S 4c		
	8,4	M8 (5m)	5,5	7,9	177,284	6359	IRCM 103 / 132 S 4c		
	10,5	M8 (5m)	7,5	10	143,552	7021	IRCM 103 / 132 M 4b		
	12,8	M8 (5m)	7,5	12	119,126	5826	IRCM 103 / 132 M 4b		
	13,9	M8 (5m)	9,2	13	109,276	6556	IRCM 103 / 132 M 4c		
	16,0	M8 (5m)	9,2	15	95,896	5753	IRCM 103 / 132 M 4c		
	19,2	M8 (5m)	11	18	78,692	5645	IRCM 103 / 160 M 4b		
	20,3	M7 (4m)	15	19	71,869	7030	IRCM 103 / 160 L 4a		
	25,6	M7 (4m)	15	24	58,778	5750	IRCM 103 / 160 L 4a		
28,8	M7 (4m)	18,5	27	51,907	6262	IRCM 103 / 180 M 4b			





D _T Tambur Çapı Drum Diameter <i>Diamètre de l'arbre</i> [mm]	V _h Kaldırma Hızı Lifting Speeds <i>Vitesse de levage</i> [m/min]	Vinç Sınıfı Crane Class <i>Classification de l'application de levage</i> ISO (FEM)	P ₁ Motor Gücü Power <i>Puissance</i> [kW]	n ₂ Çıkış Devri Output Speeds <i>Vitesse de sortie</i> [r.p.m]	i Tahvil Ratio <i>Rapport de réduction</i>	M ₂ Çıkış Momenti Output Torque <i>Couple de sortie</i>	Tip Type <i>Typ</i>		 kg
Ø360	7,9	M7 (4m)	5,5	7,0	199,476	7155	IRCM 103 / 132 S 4c		
	8,9	M7 (4m)	5,5	7,9	177,284	6359	IRCM 103 / 132 S 4c		
	11,1	M7 (4m)	7,5	10	143,552	7021	IRCM 103 / 132 M 4b		
	13,6	M7 (4m)	7,5	12	119,126	5826	IRCM 103 / 132 M 4b		
	14,7	M7 (4m)	9,2	13	109,276	6556	IRCM 103 / 132 M 4c		
	17,0	M7 (4m)	11	15	95,896	6879	IRCM 103 / 160 M 4b		
	20,3	M7 (4m)	15	18	78,692	7698	IRCM 103 / 160 L 4a		
	21,5	M7 (4m)	15	19	71,869	7030	IRCM 103 / 160 L 4a		
	27,1	M7 (4m)	15	24	58,778	5750	IRCM 103 / 160 L 4a		
Ø380	30,5	M7 (4m)	18,5	27	51,907	6262	IRCM 103 / 180 M 4b		
	8,4	M7 (4m)	5,5	7,0	199,476	7155	IRCM 103 / 132 S 4c		
	9,4	M7 (4m)	5,5	7,9	177,284	6359	IRCM 103 / 132 S 4c		
	11,7	M7 (4m)	7,5	10	143,552	7021	IRCM 103 / 132 M 4b		
	14,3	M7 (4m)	9,2	12	119,126	7147	IRCM 103 / 132 M 4c		
	15,5	M7 (4m)	9,2	13	109,276	6556	IRCM 103 / 132 M 4c		
	17,9	M7 (4m)	11	15	95,896	6879	IRCM 103 / 160 M 4b		
	21,5	M7 (4m)	15	18	78,692	7698	IRCM 103 / 160 L 4a		
	22,7	M7 (4m)	15	19	71,869	7030	IRCM 103 / 160 L 4a		
	28,6	M7 (4m)	18,5	24	58,778	7091	IRCM 103 / 180 M 4b		
32,2	M7 (4m)	18,5	27	51,907	6262	IRCM 103 / 180 M 4b			



Vinç sistemleri kaldırma redükörleri güç ve devir tabloları / Power and ratio table for hoisting applications / Tableau de classification des couples et rapports de réduction pour les applications de levage



D _T Tambur Çapı Drum Diameter Diamètre de l'arbre [mm]	V _h Kaldırma Hızı Lifting Speeds Vitesse de levage [m/min]	Vinç Sınıfı Crane Class Classification de l'application de levage ISO (FEM)	P ₁ Motor Gücü Power Puissance [kW]	n ₂ Çıkış Devri Output Speeds Vitesse de sortie [r.p.m]	i Tahvil Ratio Rapport de réduction	M ₂ Çıkış Momenti Output Torque Couple de sortie	Tip Type Typ		 kg
Ø170	2,3	M8 (5m)	1,5	8,6	162,826	1593	IRCM 93 / 90 L 4a		
	2,5	M8 (5m)	1,5	9,5	146,946	1437	IRCM 93 / 90 L 4a		
	2,7	M8 (5m)	1,5	10	133,419	1305	IRCM 93 / 90 L 4a		
	3,5	M8 (5m)	2,2	13	111,602	1601	IRCM 93 / 100 L 4a		
	4,3	M8 (5m)	3	16	87,936	1720	IRCM 93 / 100 L 4b		
	4,8	M8 (5m)	3	18	79,841	1562	IRCM 93 / 100 L 4b		
	5,6	M8 (5m)	4	21	66,785	1742	IRCM 93 / 112 M 4b		
	6,1	M8 (5m)	4	23	61,444	1603	IRCM 93 / 112 M 4b		
	6,9	M8 (5m)	4	26	54,545	1423	IRCM 93 / 112 M 4b		
	8,3	M8 (5m)	5,5	31	44,753	1605	IRCM 93 / 132 S 4c		
	10	M8 (5m)	7,5	38	37,199	1819	IRCM 93 / 132 M 4b		
	11	M8 (5m)	7,5	41	34,034	1665	IRCM 93 / 132 M 4b		
	12	M8 (5m)	7,5	45	31,194	1526	IRCM 93 / 132 M 4b		
	2,7	M7 (4m)	1,5	10	133,509	1306	IRCM 83 / 90 L 4a		
	3,2	M7 (4m)	2,2	12	121,711	1746	IRCM 83 / 100 L 4a		
	3,7	M7 (4m)	2,2	14	102,407	1469	IRCM 83 / 100 L 4a		
	4,0	M7 (4m)	3	15	92,330	1806	IRCM 83 / 100 L 4b		
	5,1	M6 (3m)	3	19	75,613	1479	IRCM 83 / 100 L 4b		
	6,1	M6 (3m)	4	23	60,299	1573	IRCM 83 / 112 M 4b		
	6,9	M6 (3m)	4	26	54,358	1418	IRCM 83 / 112 M 4b		
7,7	M6 (3m)	5,5	29	48,314	1733	IRCM 83 / 132 S 4c			
9,3	M6 (3m)	5,5	35	39,796	1427	IRCM 83 / 132 S 4c			
11	M6 (3m)	7,5	42	33,003	1614	IRCM 83 / 132 M 4b			
14	M6 (3m)	7,5	51	27,535	1347	IRCM 83 / 132 M 4b			
Ø180	2,4	M8 (5m)	1,5	8,6	162,826	1593	IRCM 93 / 90 L 4a		
	2,7	M8 (5m)	1,5	9,5	146,946	1437	IRCM 93 / 90 L 4a		
	2,8	M8 (5m)	2,2	10	133,419	1914	IRCM 93 / 100 L 4a		
	3,7	M8 (5m)	2,2	13	111,602	1601	IRCM 93 / 100 L 4a		
	4,5	M8 (5m)	3	16	87,936	1720	IRCM 93 / 100 L 4b		
	5,1	M8 (5m)	3	18	79,841	1562	IRCM 93 / 100 L 4b		
	5,9	M8 (5m)	4	21	66,785	1742	IRCM 93 / 112 M 4b		
	6,5	M8 (5m)	4	23	61,444	1603	IRCM 93 / 112 M 4b		
	7,3	M8 (5m)	5,5	26	54,545	1956	IRCM 93 / 132 S 4c		
	8,8	M8 (5m)	5,5	31	44,753	1605	IRCM 93 / 132 S 4c		
	11	M8 (5m)	7,5	38	37,199	1819	IRCM 93 / 132 M 4b		
	12	M8 (5m)	7,5	41	34,034	1665	IRCM 93 / 132 M 4b		
	13	M8 (5m)	7,5	45	31,194	1526	IRCM 93 / 132 M 4b		
	2,8	M6 (3m)	2,2	10	133,509	1915	IRCM 83 / 100 L 4a		
	3,4	M6 (3m)	2,2	12	121,711	1746	IRCM 83 / 100 L 4a		
	4,0	M6 (3m)	2,2	14	102,407	1469	IRCM 83 / 100 L 4a		
	4,2	M6 (3m)	3	15	92,330	1806	IRCM 83 / 100 L 4b		
	5,4	M6 (3m)	3	19	75,613	1479	IRCM 83 / 100 L 4b		
	6,5	M6 (3m)	4	23	60,299	1573	IRCM 83 / 112 M 4b		
	7,3	M6 (3m)	5,5	26	54,358	1950	IRCM 83 / 132 S 4c		
8,2	M6 (3m)	5,5	29	48,314	1733	IRCM 83 / 132 S 4c			
9,9	M6 (3m)	5,5	35	39,796	1427	IRCM 83 / 132 S 4c			
12	M5 (2m)	7,5	42	33,003	1614	IRCM 83 / 132 M 4b			





D _T Tambur Çapı Drum Diameter <i>Diamètre de l'arbre</i> [mm]	V _h Kaldırma Hızı Lifting Speeds <i>Vitesse de levage</i> [m/min]	Vinç Sınıfı Crane Class <i>Classification de l'application de levage</i> ISO (FEM)	P ₁ Motor Gücü Power <i>Puissance</i> [kW]	n ₂ Çıkış Devri Output Speeds <i>Vitesse de sortie</i> [r.p.m]	i Tahvil Ratio <i>Rapport de réduction</i>	M ₂ Çıkış Momenti Output Torque <i>Couple de sortie</i>	Tip Type <i>Typ</i>		 kg
Ø190	2,6	M8 (5m)	1,5	8,6	162,826	1593	IRCM 93 / 90 L 4a		
	2,8	M8 (5m)	2,2	9,5	146,946	2108	IRCM 93 / 100 L 4a		
	3,0	M8 (5m)	2,2	10	133,419	1914	IRCM 93 / 100 L 4a		
	3,9	M8 (5m)	2,2	13	111,602	1601	IRCM 93 / 100 L 4a		
	4,8	M8 (5m)	3	16	87,936	1720	IRCM 93 / 100 L 4b		
	5,4	M8 (5m)	3	18	79,841	1562	IRCM 93 / 100 L 4b		
	6,3	M8 (5m)	4	21	66,785	1742	IRCM 93 / 112 M 4b		
	6,9	M8 (5m)	4	23	61,444	1603	IRCM 93 / 112 M 4b		
	7,8	M8 (5m)	5,5	26	54,545	1956	IRCM 93 / 132 S 4c		
	9,2	M8 (5m)	5,5	31	44,753	1605	IRCM 93 / 132 S 4c		
	11	M8 (5m)	7,5	38	37,199	1819	IRCM 93 / 132 M 4b		
	12	M8 (5m)	7,5	41	34,034	1665	IRCM 93 / 132 M 4b		
	13	M8 (5m)	7,5	45	31,194	1526	IRCM 93 / 132 M 4b		
	3,0	M6 (3m)	2,2	10	133,509	1915	IRCM 83 / 100 L 4a		
	3,6	M6 (3m)	2,2	12	121,711	1746	IRCM 83 / 100 L 4a		
	4,2	M6 (3m)	3	14	102,407	2003	IRCM 83 / 100 L 4b		
	4,5	M6 (3m)	3	15	92,330	1806	IRCM 83 / 100 L 4b		
	5,7	M6 (3m)	4	19	75,613	1972	IRCM 83 / 112 M 4b		
	6,9	M6 (3m)	4	23	60,299	1573	IRCM 83 / 112 M 4b		
	7,8	M6 (3m)	5,5	26	54,358	1950	IRCM 83 / 132 S 4c		
8,7	M6 (3m)	5,5	29	48,314	1733	IRCM 83 / 132 S 4c			
10	M6 (3m)	7,5	35	39,796	1946	IRCM 83 / 132 M 4b			
13	M5 (2m)	7,5	42	33,003	1614	IRCM 83 / 132 M 4b			
15	M5 (2m)	9,2	51	27,535	1652	IRCM 83 / 132 M 4c			
Ø200	2,7	M8 (5m)	1,5	8,6	162,826	1593	IRCM 93 / 90 L 4a		
	3,0	M8 (5m)	2,2	9,5	146,946	2108	IRCM 93 / 100 L 4a		
	3,1	M8 (5m)	2,2	10	133,419	1914	IRCM 93 / 100 L 4a		
	4,1	M8 (5m)	3	13	111,602	2183	IRCM 93 / 100 L 4b		
	5,0	M8 (5m)	3	16	87,936	1720	IRCM 93 / 100 L 4b		
	5,7	M8 (5m)	4	18	79,841	2083	IRCM 93 / 112 M 4b		
	6,6	M8 (5m)	4	21	66,785	1742	IRCM 93 / 112 M 4b		
	7,2	M8 (5m)	4	23	61,444	1603	IRCM 93 / 112 M 4b		
	8,2	M8 (5m)	5,5	26	54,545	1956	IRCM 93 / 132 S 4c		
	9,7	M8 (5m)	5,5	31	44,753	1605	IRCM 93 / 132 S 4c		
	12	M8 (5m)	7,5	38	37,199	1819	IRCM 93 / 132 M 4b		
	13	M8 (5m)	7,5	41	34,034	1665	IRCM 93 / 132 M 4b		
	14	M8 (5m)	9,2	45	31,194	1872	IRCM 93 / 132 M 4c		
	3,1	M6 (3m)	2,2	10	133,509	1915	IRCM 83 / 100 L 4a		
	3,8	M6 (3m)	2,2	12	121,711	1746	IRCM 83 / 100 L 4a		
	4,4	M6 (3m)	3	14	102,407	2003	IRCM 83 / 100 L 4b		
	4,7	M6 (3m)	3	15	92,330	1806	IRCM 83 / 100 L 4b		
	6,0	M6 (3m)	4	19	75,613	1972	IRCM 83 / 112 M 4b		
	7,2	M6 (3m)	4	23	60,299	1573	IRCM 83 / 112 M 4b		
	8,2	M6 (3m)	5,5	26	54,358	1950	IRCM 83 / 132 S 4c		
9,1	M5 (2m)	5,5	29	48,314	1733	IRCM 83 / 132 S 4c			
11	M5 (2m)	7,5	35	39,796	1946	IRCM 83 / 132 M 4b			
13	M5 (2m)	7,5	42	33,003	1614	IRCM 83 / 132 M 4b			
16	M5 (2m)	9,2	51	27,535	1652	IRCM 83 / 132 M 4c			

Vinç sistemleri kaldırma redüktörleri güç ve devir tabloları / Power and ratio table for hoisting applications / Tableau de classification des couples et rapports de réduction pour les applications de levage





D _T Tambur Çapı Drum Diameter <i>Diamètre de l'arbre</i> [mm]	V _h Kaldırma Hızı Lifting Speeds <i>Vitesse de levage</i> [m/min]	Vinç Sınıfı Crane Class <i>Classification de l'application de levage</i> ISO (FEM)	P ₁ Motor Gücü Power <i>Puissance</i> [kW]	n ₂ Çıkış Devri Output Speeds <i>Vitesse de sortie</i> [r.p.m]	i Tahvil Ratio <i>Rapport de réduction</i>	M ₂ Çıkış Momenti Output Torque <i>Couple de sortie</i>	Tip Type <i>Typ</i>		 kg
Ø210	2,8	M8 (5m)	2,2	8,6	162,826	2336	IRCM 93 / 100 L 4a		
	3,1	M8 (5m)	2,2	9,5	146,946	2108	IRCM 93 / 100 L 4a		
	3,3	M8 (5m)	2,2	10	133,419	1914	IRCM 93 / 100 L 4a		
	4,3	M8 (5m)	3	13	111,602	2183	IRCM 93 / 100 L 4b		
	5,3	M8 (5m)	3	16	87,936	1720	IRCM 93 / 100 L 4b		
	5,9	M8 (5m)	4	18	79,841	2083	IRCM 93 / 112 M 4b		
	6,9	M8 (5m)	4	21	66,785	1742	IRCM 93 / 112 M 4b		
	7,6	M8 (5m)	5,5	23	61,444	2204	IRCM 93 / 132 S 4c		
	8,6	M8 (5m)	5,5	26	54,545	1956	IRCM 93 / 132 S 4c		
	10	M8 (5m)	7,5	31	44,753	2189	IRCM 93 / 132 M 4b		
	13	M8 (5m)	7,5	38	37,199	1819	IRCM 93 / 132 M 4b		
	14	M8 (5m)	7,5	41	34,034	1665	IRCM 93 / 132 M 4b		
	15	M8 (5m)	9,2	45	31,194	1872	IRCM 93 / 132 M 4c		
	3,3	M6 (3m)	2,2	10	133,509	1915	IRCM 83 / 100 L 4a		
	4,0	M6 (3m)	2,2	12	121,711	1746	IRCM 83 / 100 L 4a		
	4,6	M5 (2m)	3	14	102,407	2003	IRCM 83 / 100 L 4b		
	4,9	M5 (2m)	3	15	92,330	1806	IRCM 83 / 100 L 4b		
	6,3	M5 (2m)	4	19	75,613	1972	IRCM 83 / 112 M 4b		
	7,6	M5 (2m)	5,5	23	60,299	2163	IRCM 83 / 132 S 4c		
	8,6	M5 (2m)	5,5	26	54,358	1950	IRCM 83 / 132 S 4c		
9,6	M5 (2m)	5,5	29	48,314	1733	IRCM 83 / 132 S 4c			
12	M5 (2m)	7,5	35	39,796	1946	IRCM 83 / 132 M 4b			
14	M4 (1Am)	9,2	42	33,003	1980	IRCM 83 / 132 M 4c			
17	M4 (1Am)	11	51	27,535	1975	IRCM 83 / 160 M 4b			
Ø220	3,0	M8 (5m)	2,2	8,6	162,826	2336	IRCM 93 / 100 L 4a		
	3,3	M8 (5m)	2,2	9,5	146,946	2108	IRCM 93 / 100 L 4a		
	3,5	M8 (5m)	2,2	10	133,419	1914	IRCM 93 / 100 L 4a		
	4,5	M8 (5m)	3	13	111,602	2183	IRCM 93 / 100 L 4b		
	5,5	M8 (5m)	4	16	87,936	2294	IRCM 93 / 112 M 4b		
	6,2	M8 (5m)	4	18	79,841	2083	IRCM 93 / 112 M 4b		
	7,3	M8 (5m)	4	21	66,785	1742	IRCM 93 / 112 M 4b		
	7,9	M8 (5m)	5,5	23	61,444	2204	IRCM 93 / 132 S 4c		
	9,0	M8 (5m)	5,5	26	54,545	1956	IRCM 93 / 132 S 4c		
	11	M8 (5m)	7,5	31	44,753	2189	IRCM 93 / 132 M 4b		
	13	M8 (5m)	7,5	38	37,199	1819	IRCM 93 / 132 M 4b		
	14	M8 (5m)	9,2	41	34,034	2042	IRCM 93 / 132 M 4c		
	16	M8 (5m)	9,2	45	31,194	1872	IRCM 93 / 132 M 4c		
	3,5	M5 (2m)	2,2	10	133,509	1915	IRCM 83 / 100 L 4a		
	4,1	M5 (2m)	3	12	121,711	2381	IRCM 83 / 100 L 4b		
	4,8	M5 (2m)	3	14	102,407	2003	IRCM 83 / 100 L 4b		
	5,2	M5 (2m)	3	15	92,330	1806	IRCM 83 / 100 L 4b		
	6,6	M5 (2m)	4	19	75,613	1972	IRCM 83 / 112 M 4b		
	7,9	M5 (2m)	5,5	23	60,299	2163	IRCM 83 / 132 S 4c		
	9,0	M5 (2m)	5,5	26	54,358	1950	IRCM 83 / 132 S 4c		
10	M4 (1Am)	7,5	29	48,314	2363	IRCM 83 / 132 M 4b			
12	M4 (1Am)	7,5	35	39,796	1946	IRCM 83 / 132 M 4b			
15	M4 (1Am)	9,2	42	33,003	1980	IRCM 83 / 132 M 4c			





D _T Tambur Çapı Drum Diameter <i>Diamètre de l'arbre</i> [mm]	V _h Kaldırma Hızı Lifting Speeds <i>Vitesse de levage</i> [m/min]	Vinç Sınıfı Crane Class <i>Classification de l'application de levage</i> ISO (FEM)	P ₁ Motor Gücü Power <i>Puissance</i> [kW]	n ₂ Çıkış Devri Output Speeds <i>Vitesse de sortie</i> [r.p.m]	i Tahvil Ratio <i>Rapport de réduction</i>	M ₂ Çıkış Momenti Output Torque <i>Couple de sortie</i>	Tip Type <i>Typ</i>		 kg
Ø230	3,1	M8 (5m)	2,2	8,6	162,826	2336	IRCM 93 / 100 L 4a		
	3,4	M8 (5m)	2,2	9,5	146,946	2108	IRCM 93 / 100 L 4a		
	3,6	M8 (5m)	2,2	10	133,419	1914	IRCM 93 / 100 L 4a		
	4,7	M8 (5m)	3	13	111,602	2183	IRCM 93 / 100 L 4b		
	5,8	M8 (5m)	4	16	87,936	2294	IRCM 93 / 112 M 4b		
	6,5	M8 (5m)	4	18	79,841	2083	IRCM 93 / 112 M 4b		
	7,6	M8 (5m)	5,5	21	66,785	2395	IRCM 93 / 132 S 4c		
	8,3	M8 (5m)	5,5	23	61,444	2204	IRCM 93 / 132 S 4c		
	9,4	M8 (5m)	5,5	26	54,545	1956	IRCM 93 / 132 S 4c		
	11	M8 (5m)	7,5	31	44,753	2189	IRCM 93 / 132 M 4b		
	14	M8 (5m)	9,2	38	37,199	2232	IRCM 93 / 132 M 4c		
	15	M8 (5m)	9,2	41	34,034	2042	IRCM 93 / 132 M 4c		
	16	M8 (5m)	9,2	45	31,194	1872	IRCM 93 / 132 M 4c		
	3,6	M5 (2m)	2,2	10	133,509	1915	IRCM 83 / 100 L 4a		
	4,3	M5 (2m)	3	12	121,711	2381	IRCM 83 / 100 L 4b		
	5,1	M5 (2m)	3	14	102,407	2003	IRCM 83 / 100 L 4b		
	5,4	M5 (2m)	3	15	92,330	1806	IRCM 83 / 100 L 4b		
	6,9	M4 (1Am)	4	19	75,613	1972	IRCM 83 / 112 M 4b		
	8,3	M4 (1Am)	5,5	23	60,299	2163	IRCM 83 / 132 S 4c		
	9,4	M4 (1Am)	5,5	26	54,358	1950	IRCM 83 / 132 S 4c		
10	M4 (1Am)	7,5	29	48,314	2363	IRCM 83 / 132 M 4b			
13	M3 (1Bm)	7,5	35	39,796	1946	IRCM 83 / 132 M 4b			
15	M3 (1Bm)	9,2	42	33,003	1980	IRCM 83 / 132 M 4c			
Ø240	3,2	M8 (5m)	2,2	8,6	162,826	2336	IRCM 93 / 100 L 4a		
	3,6	M8 (5m)	2,2	9,5	146,946	2108	IRCM 93 / 100 L 4a		
	3,8	M8 (5m)	2,2	10	133,419	1914	IRCM 93 / 100 L 4a		
	4,9	M8 (5m)	3	13	111,602	2183	IRCM 93 / 100 L 4b		
	6,0	M8 (5m)	4	16	87,936	2294	IRCM 93 / 112 M 4b		
	6,8	M8 (5m)	4	18	79,841	2083	IRCM 93 / 112 M 4b		
	7,9	M8 (5m)	5,5	21	66,785	2395	IRCM 93 / 132 S 4c		
	8,7	M8 (5m)	5,5	23	61,444	2204	IRCM 93 / 132 S 4c		
	9,8	M8 (5m)	5,5	26	54,545	1956	IRCM 93 / 132 S 4c		
	12	M8 (5m)	7,5	31	44,753	2189	IRCM 93 / 132 M 4b		
	14	M8 (5m)	9,2	38	37,199	2232	IRCM 93 / 132 M 4c		
	15	M8 (5m)	9,2	41	34,034	2042	IRCM 93 / 132 M 4c		
	17	M8 (5m)	11	45	31,194	2238	IRCM 93 / 160 M 4b		
	3,8	M5 (2m)	2,2	10	133,509	1915	IRCM 83 / 100 L 4a		
	4,5	M4 (1Am)	3	12	121,711	2381	IRCM 83 / 100 L 4b		
	5,3	M4 (1Am)	3	14	102,407	2003	IRCM 83 / 100 L 4b		
	5,7	M4 (1Am)	4	15	92,330	2408	IRCM 83 / 112 M 4b		
	7,2	M4 (1Am)	4	19	75,613	1972	IRCM 83 / 112 M 4b		
	8,7	M4 (1Am)	5,5	23	60,299	2163	IRCM 83 / 132 S 4c		
	9,8	M4 (1Am)	5,5	26	54,358	1950	IRCM 83 / 132 S 4c		
11	M4 (1Am)	7,5	29	48,314	2363	IRCM 83 / 132 M 4b			
13	M4 (1Am)	7,5	35	39,796	1946	IRCM 83 / 132 M 4b			
16	M3 (1Bm)	9,2	42	33,003	1980	IRCM 83 / 132 M 4c			



Vinç sistemleri kaldırma redüktörleri güç ve devir tabloları / Power and ratio table for hoisting applications / Tableau de classification des couples et rapports de réduction pour les applications de levage

D _T Tambur Çapı Drum Diameter Diamètre de l'arbre [mm]	V _h Kaldırma Hızı Lifting Speeds Vitesse de levage [m/min]	Vinç Sınıfı Crane Class Classification de l'application de levage ISO (FEM)	P ₁ Motor Gücü Power Puissance [kW]	n ₂ Çıkış Devri Output Speeds Vitesse de sortie [r.p.m]	i Tahvil Ratio Rapport de réduction	M ₂ Çıkış Momenti Output Torque Couple de sortie	Tip Type Typ		 kg
Ø110	1,0	M8 (5m)	0,75	12	120,792	591	IRCM 73 / 80 M 4b		
	1,1	M8 (5m)	0,75	13	107,423	525	IRCM 73 / 80 M 4b		
	1,3	M8 (5m)	0,75	15	96,194	470	IRCM 73 / 80 M 4b		
	1,4	M8 (5m)	1,1	16	86,628	621	IRCM 73 / 90 S 4a		
	1,6	M8 (5m)	1,1	19	73,889	530	IRCM 73 / 90 S 4a		
	1,8	M8 (5m)	1,1	21	65,252	468	IRCM 73 / 90 S 4a		
	2,1	M8 (5m)	1,5	24	57,996	567	IRCM 73 / 90 L 4a		
	2,3	M8 (5m)	1,5	27	51,846	507	IRCM 73 / 90 L 4a		
	2,8	M8 (5m)	2,2	33	41,848	600	IRCM 73 / 100 L 4a		
	3,4	M8 (5m)	2,2	39	35,564	510	IRCM 73 / 100 L 4a		
	3,8	M8 (5m)	2,2	44	32,098	461	IRCM 73 / 100 L 4a		
	4,6	M8 (5m)	3	53	26,291	514	IRCM 73 / 100 L 4b		
Ø120	5,1	M8 (5m)	3	59	23,834	466	IRCM 73 / 100 L 4b		
	1,1	M8 (5m)	0,75	12	120,792	591	IRCM 73 / 80 M 4b		
	1,2	M8 (5m)	0,75	13	107,423	525	IRCM 73 / 80 M 4b		
	1,4	M8 (5m)	1,1	15	96,194	690	IRCM 73 / 90 S 4a		
	1,5	M8 (5m)	1,1	16	86,628	621	IRCM 73 / 90 S 4a		
	1,8	M8 (5m)	1,1	19	73,889	530	IRCM 73 / 90 S 4a		
	2,0	M8 (5m)	1,1	21	65,252	468	IRCM 73 / 90 S 4a		
	2,3	M8 (5m)	1,5	24	57,996	567	IRCM 73 / 90 L 4a		
	2,5	M8 (5m)	1,5	27	51,846	507	IRCM 73 / 90 L 4a		
	3,1	M8 (5m)	2,2	33	41,848	600	IRCM 73 / 100 L 4a		
	3,7	M8 (5m)	2,2	39	35,564	510	IRCM 73 / 100 L 4a		
	4,1	M8 (5m)	3	44	32,098	628	IRCM 73 / 100 L 4b		
Ø130	5,0	M8 (5m)	3	53	26,291	514	IRCM 73 / 100 L 4b		
	5,6	M8 (5m)	4	59	23,834	622	IRCM 73 / 112 M 4b		
	1,0	M8 (5m)	0,75	10	133,509	653	IRCM 83 / 80 M 4b		
	1,2	M8 (5m)	0,75	12	121,711	595	IRCM 83 / 80 M 4b		
	1,4	M8 (5m)	1,1	14	102,407	735	IRCM 83 / 90 S 4a		
	1,5	M8 (5m)	1,1	15	92,330	662	IRCM 83 / 90 S 4a		
	1,9	M8 (5m)	1,1	19	75,613	542	IRCM 83 / 90 S 4a		
	2,3	M8 (5m)	1,5	23	60,299	590	IRCM 83 / 90 L 4a		
	2,7	M8 (5m)	1,5	26	54,358	532	IRCM 83 / 90 L 4a		
	3,0	M8 (5m)	2,2	29	48,314	693	IRCM 83 / 100 L 4a		
	3,6	M8 (5m)	2,2	35	39,796	571	IRCM 83 / 100 L 4a		
	4,3	M8 (5m)	3	42	33,003	646	IRCM 83 / 100 L 4b		
Ø130	5,2	M8 (5m)	3	51	27,535	539	IRCM 83 / 100 L 4b		
	1,2	M8 (5m)	0,75	12	120,792	591	IRCM 73 / 80 M 4b		
	1,3	M8 (5m)	0,75	13	107,423	525	IRCM 73 / 80 M 4b		
	1,5	M8 (5m)	1,1	15	96,194	690	IRCM 73 / 90 S 4a		
	1,6	M8 (5m)	1,1	16	86,628	621	IRCM 73 / 90 S 4a		
	1,9	M8 (5m)	1,1	19	73,889	530	IRCM 73 / 90 S 4a		
	2,1	M8 (5m)	1,5	21	65,252	638	IRCM 73 / 90 L 4a		
	2,4	M8 (5m)	1,5	24	57,996	567	IRCM 73 / 90 L 4a		
	2,8	M8 (5m)	2,2	27	51,846	744	IRCM 73 / 100 L 4a		
	3,4	M8 (5m)	2,2	33	41,848	600	IRCM 73 / 100 L 4a		
	4,0	M8 (5m)	2,2	39	35,564	510	IRCM 73 / 100 L 4a		
	4,5	M7 (4m)	3	44	32,098	628	IRCM 73 / 100 L 4b		
Ø130	5,4	M7 (4m)	3	53	26,291	514	IRCM 73 / 100 L 4b		
	6,0	M7 (4m)	4	59	23,834	622	IRCM 73 / 112 M 4b		





D _T Tambur Çapı Drum Diameter <i>Diamètre de l'arbre</i> [mm]	V _h Kaldırma Hızı Lifting Speeds <i>Vitesse de levage</i> [m/min]	Vinç Sınıfı Crane Class <i>Classification de l'application de levage</i> ISO (FEM)	P ₁ Motor Gücü Power <i>Puissance</i> [kW]	n ₂ Çıkış Devri Output Speeds <i>Vitesse de sortie</i> [r.p.m]	i Tahvil Ratio <i>Rapport de réduction</i>	M ₂ Çıkış Momenti Output Torque <i>Couple de sortie</i>	Tip Type <i>Typ</i>		 kg
Ø140	1,1	M8 (5m)	0,75	10	133,509	653	IRCM 83 / 80 M 4b		
	1,3	M8 (5m)	0,75	12	121,711	595	IRCM 83 / 80 M 4b		
	1,5	M8 (5m)	1,1	14	102,407	735	IRCM 83 / 90 S 4a		
	1,6	M8 (5m)	1,1	15	92,330	662	IRCM 83 / 90 S 4a		
	2,1	M8 (5m)	1,5	19	75,613	740	IRCM 83 / 90 L 4a		
	2,5	M8 (5m)	1,5	23	60,299	590	IRCM 83 / 90 L 4a		
	2,9	M8 (5m)	2,2	26	54,358	780	IRCM 83 / 100 L 4a		
	3,2	M8 (5m)	2,2	29	48,314	693	IRCM 83 / 100 L 4a		
	3,8	M8 (5m)	2,2	35	39,796	571	IRCM 83 / 100 L 4a		
	4,6	M8 (5m)	3	42	33,003	646	IRCM 83 / 100 L 4b		
	5,6	M8 (5m)	4	51	27,535	718	IRCM 83 / 112 M 4b		
	1,3	M8 (5m)	0,75	12	120,792	591	IRCM 73 / 80 M 4b		
	1,4	M8 (5m)	1,1	13	107,423	771	IRCM 73 / 90 S 4a		
	1,6	M7 (4m)	1,1	15	96,194	690	IRCM 73 / 90 S 4a		
	1,8	M7 (4m)	1,1	16	86,628	621	IRCM 73 / 90 S 4a		
	2,1	M7 (4m)	1,5	19	73,889	723	IRCM 73 / 90 L 4a		
	2,3	M7 (4m)	1,5	21	65,252	638	IRCM 73 / 90 L 4a		
	2,6	M7 (4m)	1,5	24	57,996	567	IRCM 73 / 90 L 4a		
	3,0	M7 (4m)	2,2	27	51,846	744	IRCM 73 / 100 L 4a		
	3,6	M7 (4m)	2,2	33	41,848	600	IRCM 73 / 100 L 4a		
4,3	M7 (4m)	3	39	35,564	696	IRCM 73 / 100 L 4b			
4,8	M7 (4m)	3	44	32,098	628	IRCM 73 / 100 L 4b			
5,8	M7 (4m)	4	53	26,291	686	IRCM 73 / 112 M 4b			
6,5	M7 (4m)	4	59	23,834	622	IRCM 73 / 112 M 4b			
Ø150	1,2	M8 (5m)	0,75	10	133,509	653	IRCM 83 / 80 M 4b		
	1,4	M8 (5m)	1,1	12	121,711	873	IRCM 83 / 90 S 4a		
	1,6	M8 (5m)	1,1	14	102,407	735	IRCM 83 / 90 S 4a		
	1,8	M8 (5m)	1,1	15	92,330	662	IRCM 83 / 90 S 4a		
	2,2	M8 (5m)	1,5	19	75,613	740	IRCM 83 / 90 L 4a		
	2,7	M8 (5m)	1,5	23	60,299	590	IRCM 83 / 90 L 4a		
	3,1	M8 (5m)	2,2	26	54,358	780	IRCM 83 / 100 L 4a		
	3,4	M8 (5m)	2,2	29	48,314	693	IRCM 83 / 100 L 4a		
	4,1	M8 (5m)	3	35	39,796	779	IRCM 83 / 100 L 4b		
	4,9	M8 (5m)	3	42	33,003	646	IRCM 83 / 100 L 4b		
	6,0	M8 (5m)	4	51	27,535	718	IRCM 83 / 112 M 4b		
	1,4	M7 (4m)	1,1	12	120,792	866	IRCM 73 / 90 S 4a		
	1,5	M7 (4m)	1,1	13	107,423	771	IRCM 73 / 90 S 4a		
	1,8	M7 (4m)	1,1	15	96,194	690	IRCM 73 / 90 S 4a		
	1,9	M7 (4m)	1,1	16	86,628	621	IRCM 73 / 90 S 4a		
	2,2	M7 (4m)	1,5	19	73,889	723	IRCM 73 / 90 L 4a		
	2,5	M7 (4m)	1,5	21	65,252	638	IRCM 73 / 90 L 4a		
	2,8	M7 (4m)	2,2	24	57,996	832	IRCM 73 / 100 L 4a		
	3,2	M7 (4m)	2,2	27	51,846	744	IRCM 73 / 100 L 4a		
	3,9	M7 (4m)	2,2	33	41,848	600	IRCM 73 / 100 L 4a		
4,6	M7 (4m)	3	39	35,564	696	IRCM 73 / 100 L 4b			
5,2	M7 (4m)	3	44	32,098	628	IRCM 73 / 100 L 4b			
6,2	M7 (4m)	4	53	26,291	686	IRCM 73 / 112 M 4b			
6,9	M7 (4m)	4	59	23,834	622	IRCM 73 / 112 M 4b			



Vinç sistemleri kaldırma redüktörleri güç ve devir tabloları / Power and ratio table for hoisting applications / Tableau de classification des couples et rapports de réduction pour les applications de levage





Vinç sistemleri kaldırma redüktörleri güç ve devir tabloları / Power and ratio table for hoisting applications / Tableau de classification des couples et rapports de réduction pour les applications de levage

D _T Tambur Çapı Drum Diameter <i>Diamètre de l'arbre</i> [mm]	V _h Kaldırma Hızı Lifting Speeds <i>Vitesse de levage</i> [m/min]	Vinç Sınıfı Crane Class <i>Classification de l'application de levage</i> ISO (FEM)	P ₁ Motor Gücü Power <i>Puissance</i> [kW]	n ₂ Çıkış Devri Output Speeds <i>Vitesse de sortie</i> [r.p.m]	i Tahvil Ratio <i>Rapport de réduction</i>	M ₂ Çıkış Momenti Output Torque <i>Couple de sortie</i>	Tip Type <i>Typ</i>		 kg
Ø160	1,3	M8 (5m)	0,75	10	133,509	653	IRCM 83 / 80 M 4b		
	1,5	M8 (5m)	1,1	12	121,711	873	IRCM 83 / 90 S 4a		
	1,8	M8 (5m)	1,1	14	102,407	735	IRCM 83 / 90 S 4a		
	1,9	M8 (5m)	1,1	15	92,330	662	IRCM 83 / 90 S 4a		
	2,4	M8 (5m)	1,5	19	75,613	740	IRCM 83 / 90 L 4a		
	2,9	M8 (5m)	2,2	23	60,299	865	IRCM 83 / 100 L 4a		
	3,3	M8 (5m)	2,2	26	54,358	780	IRCM 83 / 100 L 4a		
	3,6	M8 (5m)	2,2	29	48,314	693	IRCM 83 / 100 L 4a		
	4,4	M8 (5m)	3	35	39,796	779	IRCM 83 / 100 L 4b		
	5,3	M8 (5m)	3	42	33,003	646	IRCM 83 / 100 L 4b		
	6,4	M8 (5m)	4	51	27,535	718	IRCM 83 / 112 M 4b		
	1,5	M7 (4m)	1,1	12	120,792	866	IRCM 73 / 90 S 4a		
	1,6	M7 (4m)	1,1	13	107,423	771	IRCM 73 / 90 S 4a		
	1,9	M7 (4m)	1,1	15	96,194	690	IRCM 73 / 90 S 4a		
	2,0	M7 (4m)	1,5	16	86,628	847	IRCM 73 / 90 L 4a		
	2,4	M7 (4m)	1,5	19	73,889	723	IRCM 73 / 90 L 4a		
	2,6	M7 (4m)	1,5	21	65,252	638	IRCM 73 / 90 L 4a		
	3,0	M7 (4m)	2,2	24	57,996	832	IRCM 73 / 100 L 4a		
	3,4	M7 (4m)	2,2	27	51,846	744	IRCM 73 / 100 L 4a		
	4,1	M7 (4m)	3	33	41,848	819	IRCM 73 / 100 L 4b		
4,9	M7 (4m)	3	39	35,564	696	IRCM 73 / 100 L 4b			
5,5	M7 (4m)	4	44	32,098	837	IRCM 73 / 112 M 4b			
6,7	M6 (3m)	4	53	26,291	686	IRCM 73 / 112 M 4b			
7,4	M6 (3m)	5,5	59	23,834	855	IRCM 73 / 132 S 4c			
Ø170	1,3	M8 (5m)	0,75	10	133,509	653	IRCM 83 / 80 M 4b		
	1,6	M8 (5m)	1,1	12	121,711	873	IRCM 83 / 90 S 4a		
	1,9	M8 (5m)	1,1	14	102,407	735	IRCM 83 / 90 S 4a		
	2,0	M8 (5m)	1,5	15	92,330	903	IRCM 83 / 90 L 4a		
	2,5	M8 (5m)	1,5	19	75,613	740	IRCM 83 / 90 L 4a		
	3,1	M8 (5m)	2,2	23	60,299	865	IRCM 83 / 100 L 4a		
	3,5	M8 (5m)	2,2	26	54,358	780	IRCM 83 / 100 L 4a		
	3,9	M8 (5m)	2,2	29	48,314	693	IRCM 83 / 100 L 4a		
	4,7	M8 (5m)	3	35	39,796	779	IRCM 83 / 100 L 4b		
	5,6	M8 (5m)	4	42	33,003	861	IRCM 83 / 112 M 4b		
	6,8	M8 (5m)	4	51	27,535	718	IRCM 83 / 112 M 4b		
	1,6	M7 (4m)	1,1	12	120,792	866	IRCM 73 / 90 S 4a		
	1,7	M7 (4m)	1,1	13	107,423	771	IRCM 73 / 90 S 4a		
	2,0	M7 (4m)	1,5	15	96,194	941	IRCM 73 / 90 L 4a		
	2,1	M7 (4m)	1,5	16	86,628	847	IRCM 73 / 90 L 4a		
	2,5	M7 (4m)	1,5	19	73,889	723	IRCM 73 / 90 L 4a		
	2,8	M7 (4m)	2,2	21	65,252	936	IRCM 73 / 100 L 4a		
	3,2	M7 (4m)	2,2	24	57,996	832	IRCM 73 / 100 L 4a		
	3,6	M7 (4m)	2,2	27	51,846	744	IRCM 73 / 100 L 4a		
	4,4	M7 (4m)	3	33	41,848	819	IRCM 73 / 100 L 4b		
5,2	M6 (3m)	3	39	35,564	696	IRCM 73 / 100 L 4b			
5,9	M6 (3m)	4	44	32,098	837	IRCM 73 / 112 M 4b			
7,1	M6 (3m)	4	53	26,291	686	IRCM 73 / 112 M 4b			
7,9	M6 (3m)	5,5	59	23,834	855	IRCM 73 / 132 S 4c			



D _T Tambur Çapı Drum Diameter <i>Diamètre de l'arbre</i> [mm]	V _h Kaldırma Hızı Lifting Speeds <i>Vitesse de levage</i> [m/min]	Vinç Sınıfı Crane Class <i>Classification de l'application de levage</i> ISO (FEM)	P ₁ Motor Gücü Power <i>Puissance</i> [kW]	n ₂ Çıkış Devri Output Speeds <i>Vitesse de sortie</i> [r.p.m]	i Tahvil Ratio <i>Rapport de réduction</i>	M ₂ Çıkış Momenti Output Torque <i>Couple de sortie</i>	Tip Type <i>Typ</i>		 kg
Ø180	1,4	M8 (5m)	1,1	10	133,509	958	IRCM 83 / 90 S 4a		
	1,7	M8 (5m)	1,1	12	121,711	873	IRCM 83 / 90 S 4a		
	2,0	M8 (5m)	1,1	14	102,407	735	IRCM 83 / 90 S 4a		
	2,1	M8 (5m)	1,5	15	92,330	903	IRCM 83 / 90 L 4a		
	2,7	M8 (5m)	1,5	19	75,613	740	IRCM 83 / 90 L 4a		
	3,2	M8 (5m)	2,2	23	60,299	865	IRCM 83 / 100 L 4a		
	3,7	M8 (5m)	2,2	26	54,358	780	IRCM 83 / 100 L 4a		
	4,1	M8 (5m)	3	29	48,314	945	IRCM 83 / 100 L 4b		
	4,9	M8 (5m)	3	35	39,796	779	IRCM 83 / 100 L 4b		
	5,9	M8 (5m)	4	42	33,003	861	IRCM 83 / 112 M 4b		
	7,2	M8 (5m)	4	51	27,535	718	IRCM 83 / 112 M 4b		
	1,7	M7 (4m)	1,1	12	120,792	866	IRCM 73 / 90 S 4a		
	1,8	M7 (4m)	1,1	13	107,423	771	IRCM 73 / 90 S 4a		
	2,1	M6 (3m)	1,5	15	96,194	941	IRCM 73 / 90 L 4a		
	2,3	M6 (3m)	1,5	16	86,628	847	IRCM 73 / 90 L 4a		
	2,7	M6 (3m)	1,5	19	73,889	723	IRCM 73 / 90 L 4a		
	3,0	M6 (3m)	2,2	21	65,252	936	IRCM 73 / 100 L 4a		
	3,4	M6 (3m)	2,2	24	57,996	832	IRCM 73 / 100 L 4a		
	3,8	M6 (3m)	2,2	27	51,846	744	IRCM 73 / 100 L 4a		
	4,7	M6 (3m)	3	33	41,848	819	IRCM 73 / 100 L 4b		
5,5	M6 (3m)	4	39	35,564	928	IRCM 73 / 112 M 4b			
6,2	M6 (3m)	4	44	32,098	837	IRCM 73 / 112 M 4b			
7,5	M6 (3m)	5,5	53	26,291	943	IRCM 73 / 132 S 4c			
Ø190	1,5	M8 (5m)	1,1	10	133,509	958	IRCM 83 / 90 S 4a		
	1,8	M8 (5m)	1,1	12	121,711	873	IRCM 83 / 90 S 4a		
	2,1	M8 (5m)	1,5	14	102,407	1002	IRCM 83 / 90 L 4a		
	2,2	M8 (5m)	1,5	15	92,330	903	IRCM 83 / 90 L 4a		
	2,8	M8 (5m)	2,2	19	75,613	1085	IRCM 83 / 100 L 4a		
	3,4	M8 (5m)	2,2	23	60,299	865	IRCM 83 / 100 L 4a		
	3,9	M8 (5m)	2,2	26	54,358	780	IRCM 83 / 100 L 4a		
	4,3	M8 (5m)	3	29	48,314	945	IRCM 83 / 100 L 4b		
	5,2	M8 (5m)	3	35	39,796	779	IRCM 83 / 100 L 4b		
	6,3	M8 (5m)	4	42	33,003	861	IRCM 83 / 112 M 4b		
7,6	M8 (5m)	5,5	51	27,535	988	IRCM 83 / 132 S 4c			
Ø200	1,6	M8 (5m)	1,1	10	133,509	958	IRCM 83 / 90 S 4a		
	1,9	M8 (5m)	1,1	12	121,711	873	IRCM 83 / 90 S 4a		
	2,2	M8 (5m)	1,5	14	102,407	1002	IRCM 83 / 90 L 4a		
	2,4	M8 (5m)	1,5	15	92,330	903	IRCM 83 / 90 L 4a		
	3,0	M8 (5m)	2,2	19	75,613	1085	IRCM 83 / 100 L 4a		
	3,6	M8 (5m)	2,2	23	60,299	865	IRCM 83 / 100 L 4a		
	4,1	M8 (5m)	3	26	54,358	1063	IRCM 83 / 100 L 4b		
	4,6	M8 (5m)	3	29	48,314	945	IRCM 83 / 100 L 4b		
	5,5	M8 (5m)	4	35	39,796	1038	IRCM 83 / 112 M 4b		
	6,6	M8 (5m)	4	42	33,003	861	IRCM 83 / 112 M 4b		
8,0	M8 (5m)	5,5	51	27,535	988	IRCM 83 / 132 S 4c			
Ø210	1,6	M8 (5m)	1,1	10	133,509	958	IRCM 83 / 90 S 4a		
	2,0	M8 (5m)	1,1	12	121,711	873	IRCM 83 / 90 S 4a		
	2,3	M8 (5m)	1,5	14	102,407	1002	IRCM 83 / 90 L 4a		
	2,5	M8 (5m)	1,5	15	92,330	903	IRCM 83 / 90 L 4a		
	3,1	M8 (5m)	2,2	19	75,613	1085	IRCM 83 / 100 L 4a		
	3,8	M8 (5m)	2,2	23	60,299	865	IRCM 83 / 100 L 4a		
	4,3	M8 (5m)	3	26	54,358	1063	IRCM 83 / 100 L 4b		
	4,8	M8 (5m)	3	29	48,314	945	IRCM 83 / 100 L 4b		
	5,8	M8 (5m)	4	35	39,796	1038	IRCM 83 / 112 M 4b		
	6,9	M8 (5m)	4	42	33,003	861	IRCM 83 / 112 M 4b		
8,4	M8 (5m)	5,5	51	27,535	988	IRCM 83 / 132 S 4c			



D _T Tambur Çapı Drum Diameter <i>Diamètre de l'arbre</i> [mm]	V _h Kaldırma Hızı Lifting Speeds <i>Vitesse de levage</i> [m/min]	Vinç Sınıfı Crane Class <i>Classification de l'application de levage</i> ISO (FEM)	P ₁ Motor Gücü Power <i>Puissance</i> [kW]	n ₂ Çıkış Devri Output Speeds <i>Vitesse de sortie</i> [r.p.m]	i Tahvil Ratio <i>Rapport de réduction</i>	M ₂ Çıkış Momenti Output Torque <i>Couple de sortie</i>	Tip Type <i>Typ</i>		 kg
Ø220	1,7	M8 (5m)	1,1	10	133,509	958	IRCM 83 / 90 S 4a		
	2,1	M8 (5m)	1,5	12	121,711	1191	IRCM 83 / 90 L 4a		
	2,4	M8 (5m)	1,5	14	102,407	1002	IRCM 83 / 90 L 4a		
	2,6	M8 (5m)	1,5	15	92,330	903	IRCM 83 / 90 L 4a		
	3,3	M8 (5m)	2,2	19	75,613	1085	IRCM 83 / 100 L 4a		
	4,0	M8 (5m)	2,2	23	60,299	865	IRCM 83 / 100 L 4a		
	4,5	M8 (5m)	3	26	54,358	1063	IRCM 83 / 100 L 4b		
	5,0	M8 (5m)	3	29	48,314	945	IRCM 83 / 100 L 4b		
	6,0	M8 (5m)	4	35	39,796	1038	IRCM 83 / 112 M 4b		
	7,3	M8 (5m)	4	42	33,003	861	IRCM 83 / 112 M 4b		
8,8	M8 (5m)	5,5	51	27,535	988	IRCM 83 / 132 S 4c			
Ø230	1,8	M8 (5m)	1,1	10	133,509	958	IRCM 83 / 90 S 4a		
	2,2	M8 (5m)	1,5	12	121,711	1191	IRCM 83 / 90 L 4a		
	2,5	M8 (5m)	1,5	14	102,407	1002	IRCM 83 / 90 L 4a		
	2,7	M8 (5m)	1,5	15	92,330	903	IRCM 83 / 90 L 4a		
	3,4	M8 (5m)	2,2	19	75,613	1085	IRCM 83 / 100 L 4a		
	4,2	M8 (5m)	3	23	60,299	1180	IRCM 83 / 100 L 4b		
	4,7	M8 (5m)	3	26	54,358	1063	IRCM 83 / 100 L 4b		
	5,2	M8 (5m)	3	29	48,314	945	IRCM 83 / 100 L 4b		
	6,3	M8 (5m)	4	35	39,796	1038	IRCM 83 / 112 M 4b		
	7,6	M8 (5m)	5,5	42	33,003	1184	IRCM 83 / 132 S 4c		
9,2	M7 (4m)	5,5	51	27,535	988	IRCM 83 / 132 S 4c			
Ø240	1,9	M8 (5m)	1,1	10	133,509	958	IRCM 83 / 90 S 4a		
	2,3	M8 (5m)	1,5	12	121,711	1191	IRCM 83 / 90 L 4a		
	2,6	M8 (5m)	1,5	14	102,407	1002	IRCM 83 / 90 L 4a		
	2,8	M8 (5m)	2,2	15	92,330	1325	IRCM 83 / 100 L 4a		
	3,6	M8 (5m)	2,2	19	75,613	1085	IRCM 83 / 100 L 4a		
	4,3	M8 (5m)	3	23	60,299	1180	IRCM 83 / 100 L 4b		
	4,9	M8 (5m)	3	26	54,358	1063	IRCM 83 / 100 L 4b		
	5,5	M8 (5m)	4	29	48,314	1260	IRCM 83 / 112 M 4b		
	6,6	M8 (5m)	4	35	39,796	1038	IRCM 83 / 112 M 4b		
	7,9	M7 (4m)	5,5	42	33,003	1184	IRCM 83 / 132 S 4c		
9,6	M7 (4m)	5,5	51	27,535	988	IRCM 83 / 132 S 4c			





D _T Tambur Çapı Drum Diameter <i>Diamètre de l'arbre</i> [mm]	V _h Kaldırma Hızı Lifting Speeds <i>Vitesse de levage</i> [m/min]	Vinç Sınıfı Crane Class <i>Classification de l'application de levage</i> ISO (FEM)	P ₁ Motor Gücü Power <i>Puissance</i> [kW]	n ₂ Çıkış Devri Output Speeds <i>Vitesse de sortie</i> [r.p.m]	i Tahvil Ratio <i>Rapport de réduction</i>	M ₂ Çıkış Momenti Output Torque <i>Couple de sortie</i>	Tip Type <i>Typ</i>		 kg
Ø280	6,2	M8 (5m)	5,5	7,1	198,333	7114	IRCM 123 / 132 S 4c		
	7,6	M8 (5m)	5,5	8,7	161,000	5775	IRCM 123 / 132 S 4c		
	8,8	M8 (5m)	7,5	10	134,473	6577	IRCM 123 / 132 M 4b		
	11	M8 (5m)	7,5	12	118,333	5788	IRCM 123 / 132 M 4b		
	11	M8 (5m)	9,2	13	105,000	6300	IRCM 123 / 132 M 4c		
	13	M8 (5m)	9,2	15	93,800	5628	IRCM 123 / 132 M 4c		
	15	M8 (5m)	11	17	84,259	6044	IRCM 123 / 160 M 4b		
	17	M8 (5m)	15	19	73,179	7158	IRCM 123 / 160 L 4a		
	19	M8 (5m)	15	22	64,396	6299	IRCM 123 / 160 L 4a		
	22	M8 (5m)	18,5	25	57,140	6894	IRCM 123 / 180 M 4b		
	24	M8 (5m)	18,5	27	51,045	6158	IRCM 123 / 180 M 4b		
	27	M8 (5m)	22	31	45,853	6578	IRCM 123 / 180 L 4b		
	6,2	M7 (4m)	5,5	7,0	199,476	7155	IRCM 103 / 132 S 4c		
	6,9	M7 (4m)	5,5	7,9	177,284	6359	IRCM 103 / 132 S 4c		
	8,6	M7 (4m)	7,5	10	143,552	7021	IRCM 103 / 132 M 4b		
	10,6	M7 (4m)	7,5	12	119,126	5826	IRCM 103 / 132 M 4b		
	11,4	M7 (4m)	9,2	13	109,276	6556	IRCM 103 / 132 M 4c		
	13,2	M7 (4m)	9,2	15	95,896	5753	IRCM 103 / 132 M 4c		
	15,8	M7 (4m)	11	18	78,692	5645	IRCM 103 / 160 M 4b		
	16,7	M7 (4m)	15	19	71,869	7030	IRCM 103 / 160 L 4a		
21,1	M7 (4m)	15	24	58,778	5750	IRCM 103 / 160 L 4a			
23,7	M7 (4m)	18,5	27	51,907	6262	IRCM 103 / 180 M 4b			
Ø290	6,5	M8 (5m)	5,5	7,1	198,333	7114	IRCM 123 / 132 S 4c		
	7,9	M8 (5m)	5,5	8,7	161,000	5775	IRCM 123 / 132 S 4c		
	9,1	M8 (5m)	7,5	10	134,473	6577	IRCM 123 / 132 M 4b		
	11	M8 (5m)	9,2	12	118,333	7099	IRCM 123 / 132 M 4c		
	12	M8 (5m)	9,2	13	105,000	6300	IRCM 123 / 132 M 4c		
	14	M8 (5m)	11	15	93,800	6729	IRCM 123 / 160 M 4b		
	15	M8 (5m)	11	17	84,259	6044	IRCM 123 / 160 M 4b		
	17	M8 (5m)	15	19	73,179	7158	IRCM 123 / 160 L 4a		
	20	M8 (5m)	15	22	64,396	6299	IRCM 123 / 160 L 4a		
	23	M8 (5m)	18,5	25	57,140	6894	IRCM 123 / 180 M 4b		
	25	M8 (5m)	18,5	27	51,045	6158	IRCM 123 / 180 M 4b		
	28	M8 (5m)	22	31	45,853	6578	IRCM 123 / 180 L 4b		
	6,4	M7 (4m)	5,5	7,0	199,476	7155	IRCM 103 / 132 S 4c		
	7,2	M7 (4m)	5,5	7,9	177,284	6359	IRCM 103 / 132 S 4c		
	8,9	M7 (4m)	7,5	10	143,552	7021	IRCM 103 / 132 M 4b		
	10,9	M7 (4m)	9,2	12	119,126	7147	IRCM 103 / 132 M 4c		
	11,8	M7 (4m)	9,2	13	109,276	6556	IRCM 103 / 132 M 4c		
	13,7	M7 (4m)	11	15	95,896	6879	IRCM 103 / 160 M 4b		
	16,4	M7 (4m)	15	18	78,692	7698	IRCM 103 / 160 L 4a		
	17,3	M7 (4m)	15	19	71,869	7030	IRCM 103 / 160 L 4a		
21,9	M7 (4m)	18,5	24	58,778	7091	IRCM 103 / 180 M 4b			
24,6	M7 (4m)	18,5	27	51,907	6262	IRCM 103 / 180 M 4b			
Ø300	6,7	M8 (5m)	5,5	7,1	198,333	7114	IRCM 123 / 132 S 4c		
	8,2	M8 (5m)	7,5	8,7	161,000	7874	IRCM 123 / 132 M 4b		
	9,4	M8 (5m)	7,5	10	134,473	6577	IRCM 123 / 132 M 4b		
	11	M8 (5m)	9,2	12	118,333	7099	IRCM 123 / 132 M 4c		
	12	M8 (5m)	9,2	13	105,000	6300	IRCM 123 / 132 M 4c		
	14	M8 (5m)	11	15	93,800	6729	IRCM 123 / 160 M 4b		
	16	M8 (5m)	15	17	84,259	8242	IRCM 123 / 160 L 4a		
	18	M8 (5m)	15	19	73,179	7158	IRCM 123 / 160 L 4a		
	21	M8 (5m)	15	22	64,396	6299	IRCM 123 / 160 L 4a		
	24	M8 (5m)	18,5	25	57,140	6894	IRCM 123 / 180 M 4b		
	25	M8 (5m)	18,5	27	51,045	6158	IRCM 123 / 180 M 4b		
	29	M8 (5m)	22	31	45,853	6578	IRCM 123 / 180 L 4b		



Vinç sistemleri kaldırma redüktörleri güç ve devir tabloları / Power and ratio table for hoisting applications / Tableau de classification des couples et rapports de réduction pour les applications de levage



D _T Tambur Çapı Drum Diameter <i>Diamètre de l'arbre</i> [mm]	V _h Kaldırma Hızı Lifting Speeds <i>Vitesse de levage</i> [m/min]	Vinç Sınıfı Crane Class <i>Classification de l'application de levage</i> ISO (FEM)	P ₁ Motor Gücü Power <i>Puissance</i> [kW]	n ₂ Çıkış Devri Output Speeds <i>Vitesse de sortie</i> [r.p.m]	i Tahvil Ratio <i>Rapport de réduction</i>	M ₂ Çıkış Momenti Output Torque <i>Couple de sortie</i>	Tip Type <i>Typ</i>		 kg
Ø300	6,6	M7 (4m)	5,5	7,0	199,476	7155	IRCM 103 / 132 S 4c		
	7,4	M7 (4m)	5,5	7,9	177,284	6359	IRCM 103 / 132 S 4c		
	9,2	M7 (4m)	7,5	10	143,552	7021	IRCM 103 / 132 M 4b		
	11,3	M7 (4m)	9,2	12	119,126	7147	IRCM 103 / 132 M 4c		
	12,2	M7 (4m)	9,2	13	109,276	6556	IRCM 103 / 132 M 4c		
	14,1	M7 (4m)	11	15	95,896	6879	IRCM 103 / 160 M 4b		
	17,0	M7 (4m)	15	18	78,692	7698	IRCM 103 / 160 L 4a		
	17,9	M7 (4m)	15	19	71,869	7030	IRCM 103 / 160 L 4a		
	22,6	M7 (4m)	18,5	24	58,778	7091	IRCM 103 / 180 M 4b		
Ø310	25,4	M7 (4m)	18,5	27	51,907	6262	IRCM 103 / 180 M 4b		
	6,8	M7 (4m)	5,5	7,0	199,476	7155	IRCM 103 / 132 S 4c		
	7,7	M7 (4m)	5,5	7,9	177,284	6359	IRCM 103 / 132 S 4c		
	9,5	M7 (4m)	7,5	10	143,552	7021	IRCM 103 / 132 M 4b		
	11,7	M7 (4m)	9,2	12	119,126	7147	IRCM 103 / 132 M 4c		
	12,7	M7 (4m)	9,2	13	109,276	6556	IRCM 103 / 132 M 4c		
	14,6	M7 (4m)	11	15	95,896	6879	IRCM 103 / 160 M 4b		
	17,5	M7 (4m)	15	18	78,692	7698	IRCM 103 / 160 L 4a		
	18,5	M7 (4m)	15	19	71,869	7030	IRCM 103 / 160 L 4a		
Ø320	23,4	M7 (4m)	18,5	24	58,778	7091	IRCM 103 / 180 M 4b		
	26,3	M7 (4m)	18,5	27	51,907	6262	IRCM 103 / 180 M 4b		
	7,1	M8 (5m)	5,5	7,1	198,333	7114	IRCM 123 / 132 S 4c		
	8,7	M8 (5m)	7,5	8,7	161,000	7874	IRCM 123 / 132 M 4b		
	10	M8 (5m)	7,5	10	134,473	6577	IRCM 123 / 132 M 4b		
	12	M8 (5m)	9,2	12	118,333	7099	IRCM 123 / 132 M 4c		
	13	M8 (5m)	9,2	13	105,000	6300	IRCM 123 / 132 M 4c		
	15	M8 (5m)	11	15	93,800	6729	IRCM 123 / 160 M 4b		
	17	M8 (5m)	15	17	84,259	8242	IRCM 123 / 160 L 4a		
Ø330	19	M8 (5m)	15	19	73,179	7158	IRCM 123 / 160 L 4a		
	22	M8 (5m)	18,5	22	64,396	7769	IRCM 123 / 180 M 4b		
	25	M8 (5m)	18,5	25	57,140	6894	IRCM 123 / 180 M 4b		
	27	M8 (5m)	22	27	51,045	7323	IRCM 123 / 180 L 4b		
	31	M8 (5m)	22	31	45,853	6578	IRCM 123 / 180 L 4b		
	7,0	M7 (4m)	5,5	7,0	199,476	7155	IRCM 103 / 132 S 4c		
	7,9	M7 (4m)	5,5	7,9	177,284	6359	IRCM 103 / 132 S 4c		
	9,8	M7 (4m)	7,5	10	143,552	7021	IRCM 103 / 132 M 4b		
	12,1	M7 (4m)	9,2	12	119,126	7147	IRCM 103 / 132 M 4c		
Ø340	13,1	M7 (4m)	9,2	13	109,276	6556	IRCM 103 / 132 M 4c		
	15,1	M7 (4m)	11	15	95,896	6879	IRCM 103 / 160 M 4b		
	18,1	M7 (4m)	15	18	78,692	7698	IRCM 103 / 160 L 4a		
	19,1	M7 (4m)	15	19	71,869	7030	IRCM 103 / 160 L 4a		
	24,1	M7 (4m)	18,5	24	58,778	7091	IRCM 103 / 180 M 4b		
	27,1	M6 (3m)	22	27	51,907	7447	IRCM 103 / 180 L 4b		
	7,3	M7 (4m)	5,5	7,0	199,476	7155	IRCM 103 / 132 S 4c		
	8,2	M7 (4m)	7,5	7,9	177,284	8671	IRCM 103 / 132 M 4b		
	10,2	M7 (4m)	7,5	10	143,552	7021	IRCM 103 / 132 M 4b		
Ø350	12,4	M7 (4m)	9,2	12	119,126	7147	IRCM 103 / 132 M 4c		
	13,5	M7 (4m)	11	13	109,276	7839	IRCM 103 / 160 M 4b		
	15,5	M7 (4m)	11	15	95,896	6879	IRCM 103 / 160 M 4b		
	18,7	M7 (4m)	15	18	78,692	7698	IRCM 103 / 160 L 4a		
	19,7	M7 (4m)	15	19	71,869	7030	IRCM 103 / 160 L 4a		
	24,9	M7 (4m)	18,5	24	58,778	7091	IRCM 103 / 180 M 4b		
	28,0	M6 (3m)	22	27	51,907	7447	IRCM 103 / 180 L 4b		



D _T Tambur Çapı Drum Diameter <i>Diamètre de l'arbre</i> [mm]	V _h Kaldırma Hızı Lifting Speeds <i>Vitesse de levage</i> [m/min]	Vinç Sınıfı Crane Class <i>Classification de l'application de levage</i> ISO (FEM)	P ₁ Motor Gücü Power <i>Puissance</i> [kW]	n ₂ Çıkış Devri Output Speeds <i>Vitesse de sortie</i> [r.p.m]	i Tahvil Ratio <i>Rapport de réduction</i>	M ₂ Çıkış Momenti Output Torque <i>Couple de sortie</i>	Tip Type <i>Typ</i>		 kg
Ø340	7,6	M8 (5m)	5,5	7,1	198,333	7114	IRCM 123 / 132 S 4c		
	9,3	M8 (5m)	7,5	8,7	161,000	7874	IRCM 123 / 132 M 4b		
	11	M8 (5m)	7,5	10	134,473	6577	IRCM 123 / 132 M 4b		
	13	M8 (5m)	9,2	12	118,333	7099	IRCM 123 / 132 M 4c		
	14	M8 (5m)	11	13	105,000	7532	IRCM 123 / 160 M 4b		
	16	M8 (5m)	15	15	93,800	9175	IRCM 123 / 160 L 4a		
	18	M8 (5m)	15	17	84,259	8242	IRCM 123 / 160 L 4a		
	20	M8 (5m)	15	19	73,179	7158	IRCM 123 / 160 L 4a		
	23	M8 (5m)	18,5	22	64,396	7769	IRCM 123 / 180 M 4b		
	27	M8 (5m)	18,5	25	57,140	6894	IRCM 123 / 180 M 4b		
	29	M8 (5m)	22	27	51,045	7323	IRCM 123 / 180 L 4b		
	33	M8 (5m)	30	31	45,853	8971	IRCM 123 / 200 L 4c		
	7,5	M7 (4m)	5,5	7,0	199,476	7155	IRCM 103 / 132 S 4c		
	8,4	M7 (4m)	7,5	7,9	177,284	8671	IRCM 103 / 132 M 4b		
	10,5	M7 (4m)	7,5	10	143,552	7021	IRCM 103 / 132 M 4b		
	12,8	M7 (4m)	9,2	12	119,126	7147	IRCM 103 / 132 M 4c		
	13,9	M7 (4m)	11	13	109,276	7839	IRCM 103 / 160 M 4b		
	16,0	M7 (4m)	15	15	95,896	9380	IRCM 103 / 160 L 4a		
	19,2	M7 (4m)	15	18	78,692	7698	IRCM 103 / 160 L 4a		
	20,3	M7 (4m)	15	19	71,869	7030	IRCM 103 / 160 L 4a		
25,6	M6 (3m)	18,5	24	58,778	7091	IRCM 103 / 180 M 4b			
28,8	M6 (3m)	22	27	51,907	7447	IRCM 103 / 180 L 4b			
Ø360	8,0	M8 (5m)	7,5	7,1	198,333	9700	IRCM 123 / 132 M 4b		
	9,8	M8 (5m)	7,5	8,7	161,000	7874	IRCM 123 / 132 M 4b		
	11	M8 (5m)	9,2	10	134,473	8068	IRCM 123 / 132 M 4c		
	14	M8 (5m)	11	12	118,333	8489	IRCM 123 / 160 M 4b		
	15	M8 (5m)	11	13	105,000	7532	IRCM 123 / 160 M 4b		
	17	M8 (5m)	15	15	93,800	9175	IRCM 123 / 160 L 4a		
	19	M8 (5m)	15	17	84,259	8242	IRCM 123 / 160 L 4a		
	21	M8 (5m)	15	19	73,179	7158	IRCM 123 / 160 L 4a		
	25	M8 (5m)	18,5	22	64,396	7769	IRCM 123 / 180 M 4b		
	28	M8 (5m)	22	25	57,140	8198	IRCM 123 / 180 L 4b		
	31	M8 (5m)	22	27	51,045	7323	IRCM 123 / 180 L 4b		
	35	M7 (4m)	30	31	45,853	8971	IRCM 123 / 200 L 4c		
	7,9	M6 (3m)	5,5	7,0	199,476	7155	IRCM 103 / 132 S 4c		
	8,9	M6 (3m)	7,5	7,9	177,284	8671	IRCM 103 / 132 M 4b		
	11,1	M6 (3m)	9,2	10	143,552	8613	IRCM 103 / 132 M 4c		
	13,6	M6 (3m)	11	12	119,126	8545	IRCM 103 / 160 M 4b		
	14,7	M6 (3m)	11	13	109,276	7839	IRCM 103 / 160 M 4b		
	17,0	M6 (3m)	15	15	95,896	9380	IRCM 103 / 160 L 4a		
	20,3	M6 (3m)	15	18	78,692	7698	IRCM 103 / 160 L 4a		
	21,5	M6 (3m)	15	19	71,869	7030	IRCM 103 / 160 L 4a		
27,1	M6 (3m)	22	24	58,778	8433	IRCM 103 / 180 L 4b			
30,5	M6 (3m)	22	27	51,907	7447	IRCM 103 / 180 L 4b			
Ø380	8,5	M8 (5m)	7,5	7,1	198,333	9700	IRCM 123 / 132 M 4b		
	10	M7 (4m)	7,5	8,7	161,000	7874	IRCM 123 / 132 M 4b		
	12	M7 (4m)	9,2	10	134,473	8068	IRCM 123 / 132 M 4c		
	14	M7 (4m)	11	12	118,333	8489	IRCM 123 / 160 M 4b		
	16	M7 (4m)	11	13	105,000	7532	IRCM 123 / 160 M 4b		
	18	M7 (4m)	15	15	93,800	9175	IRCM 123 / 160 L 4a		
	20	M7 (4m)	15	17	84,259	8242	IRCM 123 / 160 L 4a		
	23	M7 (4m)	18,5	19	73,179	8829	IRCM 123 / 180 M 4b		
	26	M7 (4m)	18,5	22	64,396	7769	IRCM 123 / 180 M 4b		
	30	M7 (4m)	22	25	57,140	8198	IRCM 123 / 180 L 4b		
	32	M7 (4m)	30	27	51,045	9986	IRCM 123 / 200 L 4c		
	37	M7 (4m)	30	31	45,853	8971	IRCM 123 / 200 L 4c		



Vinç sistemleri kaldırma redüktörleri güç ve devir tabloları / Power and ratio table for hoisting applications / Tableau de classification des couples et rapports de réduction pour les applications de levage

D _T Tambur Çapı Drum Diameter <i>Diamètre de l'arbre</i> [mm]	V _h Kaldırma Hızı Lifting Speeds <i>Vitesse de levage</i> [m/min]	Vinç Sınıfı Crane Class <i>Classification de l'application de levage</i> ISO (FEM)	P ₁ Motor Gücü Power <i>Puissance</i> [kW]	n ₂ Çıkış Devri Output Speeds <i>Vitesse de sortie</i> [r.p.m]	i Tahvil Ratio <i>Rapport de réduction</i>	M ₂ Çıkış Momenti Output Torque <i>Couple de sortie</i>	Tip Type <i>Typ</i>		 kg
Ø400	8,4	M6 (3m)	7,5	7,0	199,476	9756	IRCM 103 / 132 M 4b		
	9,4	M6 (3m)	7,5	7,9	177,284	8671	IRCM 103 / 132 M 4b		
	11,7	M6 (3m)	9,2	10	143,552	8613	IRCM 103 / 132 M 4c		
	14,3	M6 (3m)	11	12	119,126	8545	IRCM 103 / 160 M 4b		
	15,5	M6 (3m)	11	13	109,276	7839	IRCM 103 / 160 M 4b		
	17,9	M6 (3m)	15	15	95,896	9380	IRCM 103 / 160 L 4a		
	21,5	M6 (3m)	15	18	78,692	7698	IRCM 103 / 160 L 4a		
	22,7	M6 (3m)	18,5	19	71,869	8671	IRCM 103 / 180 M 4b		
	28,6	M6 (3m)	22	24	58,778	8433	IRCM 103 / 180 L 4b		
	32,2	M5 (2m)	30	27	51,907	10155	IRCM 103 / 200 L 4c		
	8,9	M7 (4m)	7,5	7,1	198,333	9700	IRCM 123 / 132 M 4b		
	11	M7 (4m)	9,2	8,7	161,000	9659	IRCM 123 / 132 M 4c		
	13	M7 (4m)	9,2	10	134,473	8068	IRCM 123 / 132 M 4c		
	15	M7 (4m)	11	12	118,333	8489	IRCM 123 / 160 M 4b		
	16	M7 (4m)	15	13	105,000	10271	IRCM 123 / 160 L 4a		
	19	M7 (4m)	15	15	93,800	9175	IRCM 123 / 160 L 4a		
	21	M7 (4m)	15	17	84,259	8242	IRCM 123 / 160 L 4a		
	24	M7 (4m)	18,5	19	73,179	8829	IRCM 123 / 180 M 4b		
28	M7 (4m)	22	22	64,396	9239	IRCM 123 / 180 L 4b			
31	M7 (4m)	22	25	57,140	8198	IRCM 123 / 180 L 4b			
34	M7 (4m)	30	27	51,045	9986	IRCM 123 / 200 L 4c			
39	M7 (4m)	30	31	45,853	8971	IRCM 123 / 200 L 4c			
8,8	M6 (3m)	7,5	7,0	199,476	9756	IRCM 103 / 132 M 4b			
9,9	M6 (3m)	7,5	7,9	177,284	8671	IRCM 103 / 132 M 4b			
12,3	M6 (3m)	9,2	10	143,552	8613	IRCM 103 / 132 M 4c			
15,1	M6 (3m)	11	12	119,126	8545	IRCM 103 / 160 M 4b			
16,3	M6 (3m)	15	13	109,276	10689	IRCM 103 / 160 L 4a			
18,8	M6 (3m)	15	15	95,896	9380	IRCM 103 / 160 L 4a			
22,6	M6 (3m)	18,5	18	78,692	9494	IRCM 103 / 180 M 4b			
23,9	M6 (3m)	18,5	19	71,869	8671	IRCM 103 / 180 M 4b			
30,1	M6 (3m)	22	24	58,778	8433	IRCM 103 / 180 L 4b			
33,9	M5 (2m)	30	27	51,907	10155	IRCM 103 / 200 L 4c			
Ø420	9,4	M7 (4m)	7,5	7,1	198,333	9700	IRCM 123 / 132 M 4b		
	11	M7 (4m)	9,2	8,7	161,000	9659	IRCM 123 / 132 M 4c		
	13	M7 (4m)	9,2	10	134,473	8068	IRCM 123 / 132 M 4c		
	16	M7 (4m)	11	12	118,333	8489	IRCM 123 / 160 M 4b		
	17	M7 (4m)	15	13	105,000	10271	IRCM 123 / 160 L 4a		
	20	M7 (4m)	15	15	93,800	9175	IRCM 123 / 160 L 4a		
	22	M7 (4m)	18,5	17	84,259	10165	IRCM 123 / 180 M 4b		
	25	M7 (4m)	18,5	19	73,179	8829	IRCM 123 / 180 M 4b		
	29	M7 (4m)	22	22	64,396	9239	IRCM 123 / 180 L 4b		
	33	M7 (4m)	30	25	57,140	11179	IRCM 123 / 200 L 4c		
	36	M7 (4m)	30	27	51,045	9986	IRCM 123 / 200 L 4c		
	41	M7 (4m)	30	31	45,853	8971	IRCM 123 / 200 L 4c		
	9,2	M6 (3m)	7,5	7,0	199,476	9756	IRCM 103 / 132 M 4b		
	10,4	M6 (3m)	7,5	7,9	177,284	8671	IRCM 103 / 132 M 4b		
	12,9	M6 (3m)	9,2	10	143,552	8613	IRCM 103 / 132 M 4c		
	15,8	M6 (3m)	11	12	119,126	8545	IRCM 103 / 160 M 4b		
	17,1	M6 (3m)	15	13	109,276	10689	IRCM 103 / 160 L 4a		
	19,8	M6 (3m)	15	15	95,896	9380	IRCM 103 / 160 L 4a		
	23,7	M6 (3m)	18,5	18	78,692	9494	IRCM 103 / 180 M 4b		
	25,1	M6 (3m)	18,5	19	71,869	8671	IRCM 103 / 180 M 4b		
	31,7	M5 (2m)	22	24	58,778	8433	IRCM 103 / 180 L 4b		
	35,6	M5 (2m)	30	27	51,907	10155	IRCM 103 / 200 L 4c		





D _T Tambur Çapı Drum Diameter <i>Diamètre de l'arbre</i> [mm]	V _h Kaldırma Hızı Lifting Speeds <i>Vitesse de levage</i> [m/min]	Vinç Sınıfı Crane Class <i>Classification de l'application de levage</i> ISO (FEM)	P ₁ Motor Gücü Power <i>Puissance</i> [kW]	n ₂ Çıkış Devri Output Speeds <i>Vitesse de sortie</i> [r.p.m]	i Tahvil Ratio <i>Rapport de réduction</i>	M ₂ Çıkış Momenti Output Torque <i>Couple de sortie</i>	Tip Type <i>Typ</i>		 kg
Ø440	10	M7 (4m)	7,5	7,1	198,333	9700	IRCM 123 / 132 M 4b		
	12	M7 (4m)	9,2	8,7	161,000	9659	IRCM 123 / 132 M 4c		
	14	M7 (4m)	11	10	134,473	9646	IRCM 123 / 160 M 4b		
	17	M7 (4m)	15	12	118,333	11575	IRCM 123 / 160 L 4a		
	18	M7 (4m)	15	13	105,000	10271	IRCM 123 / 160 L 4a		
	21	M7 (4m)	15	15	93,800	9175	IRCM 123 / 160 L 4a		
	23	M7 (4m)	18,5	17	84,259	10165	IRCM 123 / 180 M 4b		
	26	M7 (4m)	18,5	19	73,179	8829	IRCM 123 / 180 M 4b		
	30	M7 (4m)	22	22	64,396	9239	IRCM 123 / 180 L 4b		
	35	M7 (4m)	30	25	57,140	11179	IRCM 123 / 200 L 4c		
	37	M7 (4m)	30	27	51,045	9986	IRCM 123 / 200 L 4c		
43	M7 (4m)	30	31	45,853	8971	IRCM 123 / 200 L 4c			
Ø450	10	M7 (4m)	7,5	7,1	198,333	9700	IRCM 123 / 132 M 4b		
	12	M7 (4m)	9,2	8,7	161,000	9659	IRCM 123 / 132 M 4c		
	14	M7 (4m)	11	10	134,473	9646	IRCM 123 / 160 M 4b		
	17	M7 (4m)	15	12	118,333	11575	IRCM 123 / 160 L 4a		
	18	M7 (4m)	15	13	105,000	10271	IRCM 123 / 160 L 4a		
	21	M7 (4m)	15	15	93,800	9175	IRCM 123 / 160 L 4a		
	24	M7 (4m)	18,5	17	84,259	10165	IRCM 123 / 180 M 4b		
	27	M7 (4m)	18,5	19	73,179	8829	IRCM 123 / 180 M 4b		
	31	M7 (4m)	22	22	64,396	9239	IRCM 123 / 180 L 4b		
	35	M7 (4m)	30	25	57,140	11179	IRCM 123 / 200 L 4c		
	38	M7 (4m)	30	27	51,045	9986	IRCM 123 / 200 L 4c		
44	M7 (4m)	37	31	45,853	11064	IRCM 123 / 225 S 4a			



Vinç sistemleri kaldırma redüktörleri güç ve devir tabloları / Power and ratio table for hoisting applications / Tableau de classification des couples et rapports de réduction pour les applications de levage

D _T Tambur Çapı Drum Diameter <i>Diamètre de l'arbre</i> [mm]	V _h Kaldırma Hızı Lifting Speeds <i>Vitesse de levage</i> [m/min]	Vinç Sınıfı Crane Class <i>Classification de l'application de levage</i> ISO (FEM)	P ₁ Motor Gücü Power <i>Puissance</i> [kW]	n ₂ Çıkış Devri Output Speeds <i>Vitesse de sortie</i> [r.p.m]	i Tahvil Ratio <i>Rapport de réduction</i>	M ₂ Çıkış Momenti Output Torque <i>Couple de sortie</i>	Tip Type <i>Typ</i>		 kg
Ø230	2,5	M8 (5m)	2,2	7,0	199,476	2862	IRCM 103 / 100 L 4a		
	2,9	M8 (5m)	2,2	7,9	177,284	2543	IRCM 103 / 100 L 4a		
	3,5	M8 (5m)	3	10	143,552	2808	IRCM 103 / 100 L 4b		
	4,3	M8 (5m)	3	12	119,126	2331	IRCM 103 / 100 L 4b		
	4,7	M8 (5m)	4	13	109,276	2850	IRCM 103 / 112 M 4b		
	5,4	M8 (5m)	4	15	95,896	2501	IRCM 103 / 112 M 4b		
	6,5	M8 (5m)	5,5	18	78,692	2822	IRCM 103 / 132 S 4c		
	6,9	M8 (5m)	5,5	19	71,869	2578	IRCM 103 / 132 S 4c		
	8,7	M8 (5m)	7,5	24	58,778	2875	IRCM 103 / 132 M 4b		
	9,7	M8 (5m)	7,5	27	51,907	2539	IRCM 103 / 132 M 4b		
	3,1	M8 (5m)	2,2	8,6	162,826	2336	IRCM 93 / 100 L 4a		
	3,4	M8 (5m)	3	9,5	146,946	2875	IRCM 93 / 100 L 4b		
	3,6	M8 (5m)	3	10	133,419	2610	IRCM 93 / 100 L 4b		
	4,7	M8 (5m)	4	13	111,602	2911	IRCM 93 / 112 M 4b		
	5,8	M8 (5m)	4	16	87,936	2294	IRCM 93 / 112 M 4b		
	6,5	M8 (5m)	5,5	18	79,841	2864	IRCM 93 / 132 S 4c		
	7,6	M7 (4m)	5,5	21	66,785	2395	IRCM 93 / 132 S 4c		
	8,3	M7 (4m)	7,5	23	61,444	3005	IRCM 93 / 132 M 4b		
	9,4	M7 (4m)	7,5	26	54,545	2668	IRCM 93 / 132 M 4b		
	11	M7 (4m)	9,2	31	44,753	2685	IRCM 93 / 132 M 4c		
14	M7 (4m)	11	38	37,199	2668	IRCM 93 / 160 M 4b			
15	M7 (4m)	11	41	34,034	2441	IRCM 93 / 160 M 4b			
16	M7 (4m)	15	45	31,194	3051	IRCM 93 / 160 L 4a			
Ø240	2,6	M8 (5m)	2,2	7,0	199,476	2862	IRCM 103 / 100 L 4a		
	3,0	M8 (5m)	2,2	7,9	177,284	2543	IRCM 103 / 100 L 4a		
	3,7	M8 (5m)	3	10	143,552	2808	IRCM 103 / 100 L 4b		
	4,5	M8 (5m)	4	12	119,126	3107	IRCM 103 / 112 M 4b		
	4,9	M8 (5m)	4	13	109,276	2850	IRCM 103 / 112 M 4b		
	5,7	M8 (5m)	4	15	95,896	2501	IRCM 103 / 112 M 4b		
	6,8	M8 (5m)	5,5	18	78,692	2822	IRCM 103 / 132 S 4c		
	7,2	M8 (5m)	5,5	19	71,869	2578	IRCM 103 / 132 S 4c		
	9,0	M8 (5m)	7,5	24	58,778	2875	IRCM 103 / 132 M 4b		
	10,2	M8 (5m)	7,5	27	51,907	2539	IRCM 103 / 132 M 4b		
	3,2	M8 (5m)	3	8,6	162,826	3186	IRCM 93 / 100 L 4b		
	3,6	M8 (5m)	3	9,5	146,946	2875	IRCM 93 / 100 L 4b		
	3,8	M8 (5m)	3	10	133,419	2610	IRCM 93 / 100 L 4b		
	4,9	M8 (5m)	4	13	111,602	2911	IRCM 93 / 112 M 4b		
	6,0	M8 (5m)	5,5	16	87,936	3154	IRCM 93 / 132 S 4c		
	6,8	M7 (4m)	5,5	18	79,841	2864	IRCM 93 / 132 S 4c		
	7,9	M7 (4m)	5,5	21	66,785	2395	IRCM 93 / 132 S 4c		
	8,7	M7 (4m)	7,5	23	61,444	3005	IRCM 93 / 132 M 4b		
	9,8	M7 (4m)	7,5	26	54,545	2668	IRCM 93 / 132 M 4b		
	12	M7 (4m)	9,2	31	44,753	2685	IRCM 93 / 132 M 4c		
14	M7 (4m)	11	38	37,199	2668	IRCM 93 / 160 M 4b			
15	M7 (4m)	11	41	34,034	2441	IRCM 93 / 160 M 4b			
17	M7 (4m)	15	45	31,194	3051	IRCM 93 / 160 L 4a			
	2,7	M8 (5m)	2,2	7,0	199,476	2862	IRCM 103 / 100 L 4a		
	3,1	M8 (5m)	2,2	7,9	177,284	2543	IRCM 103 / 100 L 4a		
	3,8	M8 (5m)	3	10	143,552	2808	IRCM 103 / 100 L 4b		
	4,7	M8 (5m)	4	12	119,126	3107	IRCM 103 / 112 M 4b		
	5,1	M8 (5m)	4	13	109,276	2850	IRCM 103 / 112 M 4b		
	5,9	M8 (5m)	5,5	15	95,896	3440	IRCM 103 / 132 S 4c		
	7,1	M8 (5m)	5,5	18	78,692	2822	IRCM 103 / 132 S 4c		
	7,5	M8 (5m)	5,5	19	71,869	2578	IRCM 103 / 132 S 4c		
	9,4	M8 (5m)	7,5	24	58,778	2875	IRCM 103 / 132 M 4b		
	10,6	M8 (5m)	7,5	27	51,907	2539	IRCM 103 / 132 M 4b		



D _T Tambur Çapı Drum Diameter <i>Diamètre de l'arbre</i> [mm]	V _h Kaldırma Hızı Lifting Speeds <i>Vitesse de levage</i> [m/min]	Vinç Sınıfı Crane Class <i>Classification de l'application de levage</i> ISO (FEM)	P ₁ Motor Gücü Power <i>Puissance</i> [kW]	n ₂ Çıkış Devri Output Speeds <i>Vitesse de sortie</i> [r.p.m]	i Tahvil Ratio <i>Rapport de réduction</i>	M ₂ Çıkış Momenti Output Torque <i>Couple de sortie</i>	Tip Type <i>Typ</i>		 kg
Ø250	3,4	M8 (5m)	3	8,6	162,826	3186	IRCM 93 / 100 L 4b		
	3,7	M8 (5m)	3	9,5	146,946	2875	IRCM 93 / 100 L 4b		
	3,9	M8 (5m)	3	10	133,419	2610	IRCM 93 / 100 L 4b		
	5,1	M8 (5m)	4	13	111,602	2911	IRCM 93 / 112 M 4b		
	6,3	M7 (4m)	5,5	16	87,936	3154	IRCM 93 / 132 S 4c		
	7,1	M7 (4m)	5,5	18	79,841	2864	IRCM 93 / 132 S 4c		
	8,2	M7 (4m)	7,5	21	66,785	3266	IRCM 93 / 132 M 4b		
	9,0	M7 (4m)	7,5	23	61,444	3005	IRCM 93 / 132 M 4b		
	10	M7 (4m)	7,5	26	54,545	2668	IRCM 93 / 132 M 4b		
	12	M7 (4m)	9,2	31	44,753	2685	IRCM 93 / 132 M 4c		
	15	M7 (4m)	11	38	37,199	2668	IRCM 93 / 160 M 4b		
	16	M7 (4m)	15	41	34,034	3329	IRCM 93 / 160 L 4a		
	18	M7 (4m)	15	45	31,194	3051	IRCM 93 / 160 L 4a		
	Ø260	2,9	M8 (5m)	2,2	7,0	199,476	2862	IRCM 103 / 100 L 4a	
3,2		M8 (5m)	3	7,9	177,284	3468	IRCM 103 / 100 L 4b		
4,0		M8 (5m)	3	10	143,552	2808	IRCM 103 / 100 L 4b		
4,9		M8 (5m)	4	12	119,126	3107	IRCM 103 / 112 M 4b		
5,3		M8 (5m)	4	13	109,276	2850	IRCM 103 / 112 M 4b		
6,1		M8 (5m)	5,5	15	95,896	3440	IRCM 103 / 132 S 4c		
7,3		M8 (5m)	5,5	18	78,692	2822	IRCM 103 / 132 S 4c		
7,8		M8 (5m)	5,5	19	71,869	2578	IRCM 103 / 132 S 4c		
9,8		M8 (5m)	7,5	24	58,778	2875	IRCM 103 / 132 M 4b		
11,0		M8 (5m)	9,2	27	51,907	3114	IRCM 103 / 132 M 4c		
3,5		M8 (5m)	3	8,6	162,826	3186	IRCM 93 / 100 L 4b		
3,9		M8 (5m)	3	9,5	146,946	2875	IRCM 93 / 100 L 4b		
4,1		M8 (5m)	3	10	133,419	2610	IRCM 93 / 100 L 4b		
5,3		M7 (4m)	4	13	111,602	2911	IRCM 93 / 112 M 4b		
6,5		M7 (4m)	5,5	16	87,936	3154	IRCM 93 / 132 S 4c		
7,3		M7 (4m)	5,5	18	79,841	2864	IRCM 93 / 132 S 4c		
8,6		M7 (4m)	7,5	21	66,785	3266	IRCM 93 / 132 M 4b		
9,4		M7 (4m)	7,5	23	61,444	3005	IRCM 93 / 132 M 4b		
11		M7 (4m)	7,5	26	54,545	2668	IRCM 93 / 132 M 4b		
13		M7 (4m)	9,2	31	44,753	2685	IRCM 93 / 132 M 4c		
16	M7 (4m)	11	38	37,199	2668	IRCM 93 / 160 M 4b			
17	M7 (4m)	15	41	34,034	3329	IRCM 93 / 160 L 4a			
18	M7 (4m)	15	45	31,194	3051	IRCM 93 / 160 L 4a			
	3,0	M8 (5m)	2,2	7,0	199,476	2862	IRCM 103 / 100 L 4a		
	3,3	M8 (5m)	3	7,9	177,284	3468	IRCM 103 / 100 L 4b		
	4,2	M8 (5m)	3	10	143,552	2808	IRCM 103 / 100 L 4b		
	5,1	M8 (5m)	4	12	119,126	3107	IRCM 103 / 112 M 4b		
	5,5	M8 (5m)	4	13	109,276	2850	IRCM 103 / 112 M 4b		
	6,4	M8 (5m)	5,5	15	95,896	3440	IRCM 103 / 132 S 4c		
	7,6	M8 (5m)	5,5	18	78,692	2822	IRCM 103 / 132 S 4c		
	8,1	M8 (5m)	7,5	19	71,869	3515	IRCM 103 / 132 M 4b		
	10,2	M8 (5m)	7,5	24	58,778	2875	IRCM 103 / 132 M 4b		
	11,4	M8 (5m)	9,2	27	51,907	3114	IRCM 103 / 132 M 4c		



Vinç sistemleri kaldırma redüktörleri güç ve devir tabloları / Power and ratio table for hoisting applications / Tableau de classification des couples et rapports de réduction pour les applications de levage



D _T Tambur Çapı Drum Diameter Diamètre de l'arbre [mm]	V _h Kaldırma Hızı Lifting Speeds Vitesse de levage [m/min]	Vinç Sınıfı Crane Class Classification de l'application de levage ISO (FEM)	P ₁ Motor Gücü Power Puissance [kW]	n ₂ Çıkış Devri Output Speeds Vitesse de sortie [r.p.m]	i Tahvil Ratio Rapport de réduction	M ₂ Çıkış Momenti Output Torque Couple de sortie	Tip Type Typ			kg
Ø270	3,6	M7 (4m)	3	8,6	162,826	3186	IRCM 93 / 100 L 4b			
	4,0	M7 (4m)	3	9,5	146,946	2875	IRCM 93 / 100 L 4b			
	4,2	M7 (4m)	3	10	133,419	2610	IRCM 93 / 100 L 4b			
	5,5	M7 (4m)	4	13	111,602	2911	IRCM 93 / 112 M 4b			
	6,8	M7 (4m)	5,5	16	87,936	3154	IRCM 93 / 132 S 4c			
	7,6	M7 (4m)	5,5	18	79,841	2864	IRCM 93 / 132 S 4c			
	8,9	M7 (4m)	7,5	21	66,785	3266	IRCM 93 / 132 M 4b			
	9,7	M7 (4m)	7,5	23	61,444	3005	IRCM 93 / 132 M 4b			
	11	M7 (4m)	9,2	26	54,545	3272	IRCM 93 / 132 M 4c			
	13	M6 (3m)	9,2	31	44,753	2685	IRCM 93 / 132 M 4c			
	16	M6 (3m)	15	38	37,199	3639	IRCM 93 / 160 L 4a			
	17	M6 (3m)	15	41	34,034	3329	IRCM 93 / 160 L 4a			
19	M6 (3m)	15	45	31,194	3051	IRCM 93 / 160 L 4a				
Ø280	3,1	M8 (5m)	2,2	7,0	199,476	2862	IRCM 103 / 100 L 4a			
	3,5	M8 (5m)	3	7,9	177,284	3468	IRCM 103 / 100 L 4b			
	4,3	M8 (5m)	3	10	143,552	2808	IRCM 103 / 100 L 4b			
	5,3	M8 (5m)	4	12	119,126	3107	IRCM 103 / 112 M 4b			
	5,7	M8 (5m)	4	13	109,276	2850	IRCM 103 / 112 M 4b			
	6,6	M8 (5m)	5,5	15	95,896	3440	IRCM 103 / 132 S 4c			
	7,9	M8 (5m)	5,5	18	78,692	2822	IRCM 103 / 132 S 4c			
	8,4	M8 (5m)	7,5	19	71,869	3515	IRCM 103 / 132 M 4b			
	10,6	M8 (5m)	7,5	24	58,778	2875	IRCM 103 / 132 M 4b			
	11,9	M8 (5m)	9,2	27	51,907	3114	IRCM 103 / 132 M 4c			
	3,8	M7 (4m)	3	8,6	162,826	3186	IRCM 93 / 100 L 4b			
	4,2	M7 (4m)	3	9,5	146,946	2875	IRCM 93 / 100 L 4b			
	4,4	M7 (4m)	4	10	133,419	3480	IRCM 93 / 112 M 4b			
	5,7	M7 (4m)	4	13	111,602	2911	IRCM 93 / 112 M 4b			
	7,0	M7 (4m)	5,5	16	87,936	3154	IRCM 93 / 132 S 4c			
	7,9	M7 (4m)	5,5	18	79,841	2864	IRCM 93 / 132 S 4c			
	9,2	M7 (4m)	7,5	21	66,785	3266	IRCM 93 / 132 M 4b			
	10	M7 (4m)	7,5	23	61,444	3005	IRCM 93 / 132 M 4b			
	11	M6 (3m)	9,2	26	54,545	3272	IRCM 93 / 132 M 4c			
	14	M6 (3m)	11	31	44,753	3210	IRCM 93 / 160 M 4b			
17	M6 (3m)	15	38	37,199	3639	IRCM 93 / 160 L 4a				
18	M6 (3m)	15	41	34,034	3329	IRCM 93 / 160 L 4a				
20	M6 (3m)	15	45	31,194	3051	IRCM 93 / 160 L 4a				
3,2	M8 (5m)	2,2	7,0	199,476	2862	IRCM 103 / 100 L 4a				
3,6	M8 (5m)	3	7,9	177,284	3468	IRCM 103 / 100 L 4b				
4,5	M8 (5m)	4	10	143,552	3745	IRCM 103 / 112 M 4b				
5,5	M8 (5m)	4	12	119,126	3107	IRCM 103 / 112 M 4b				
5,9	M8 (5m)	5,5	13	109,276	3919	IRCM 103 / 132 S 4c				
6,8	M8 (5m)	5,5	15	95,896	3440	IRCM 103 / 132 S 4c				
8,2	M8 (5m)	7,5	18	78,692	3849	IRCM 103 / 132 M 4b				
8,7	M8 (5m)	7,5	19	71,869	3515	IRCM 103 / 132 M 4b				
10,9	M8 (5m)	9,2	24	58,778	3526	IRCM 103 / 132 M 4c				
12,3	M8 (5m)	9,2	27	51,907	3114	IRCM 103 / 132 M 4c				





D _T Tambur Çapı Drum Diameter <i>Diamètre de l'arbre</i> [mm]	V _h Kaldırma Hızı Lifting Speeds <i>Vitesse de levage</i> [m/min]	Vinç Sınıfı Crane Class <i>Classification de l'application de levage</i> ISO (FEM)	P ₁ Motor Gücü Power <i>Puissance</i> [kW]	n ₂ Çıkış Devri Output Speeds <i>Vitesse de sortie</i> [r.p.m]	i Tahvil Ratio <i>Rapport de réduction</i>	M ₂ Çıkış Momenti Output Torque <i>Couple de sortie</i>	Tip Type <i>Typ</i>		 kg
Ø290	3,9	M7 (4m)	3	8,6	162,826	3186	IRCM 93 / 100 L 4b		
	4,3	M7 (4m)	3	9,5	146,946	2875	IRCM 93 / 100 L 4b		
	4,6	M7 (4m)	4	10	133,419	3480	IRCM 93 / 112 M 4b		
	5,9	M7 (4m)	5,5	13	111,602	4003	IRCM 93 / 132 S 4c		
	7,3	M7 (4m)	5,5	16	87,936	3154	IRCM 93 / 132 S 4c		
	8,2	M7 (4m)	7,5	18	79,841	3905	IRCM 93 / 132 M 4b		
	9,6	M6 (3m)	7,5	21	66,785	3266	IRCM 93 / 132 M 4b		
	10	M6 (3m)	7,5	23	61,444	3005	IRCM 93 / 132 M 4b		
	12	M6 (3m)	9,2	26	54,545	3272	IRCM 93 / 132 M 4c		
	14	M6 (3m)	11	31	44,753	3210	IRCM 93 / 160 M 4b		
	17	M6 (3m)	15	38	37,199	3639	IRCM 93 / 160 L 4a		
	19	M6 (3m)	15	41	34,034	3329	IRCM 93 / 160 L 4a		
	20	M6 (3m)	15	45	31,194	3051	IRCM 93 / 160 L 4a		
Ø300	3,3	M8 (5m)	3	7,0	199,476	3903	IRCM 103 / 100 L 4b		
	3,7	M8 (5m)	3	7,9	177,284	3468	IRCM 103 / 100 L 4b		
	4,6	M8 (5m)	4	10	143,552	3745	IRCM 103 / 112 M 4b		
	5,7	M8 (5m)	4	12	119,126	3107	IRCM 103 / 112 M 4b		
	6,1	M8 (5m)	5,5	13	109,276	3919	IRCM 103 / 132 S 4c		
	7,1	M8 (5m)	5,5	15	95,896	3440	IRCM 103 / 132 S 4c		
	8,5	M8 (5m)	7,5	18	78,692	3849	IRCM 103 / 132 M 4b		
	8,9	M8 (5m)	7,5	19	71,869	3515	IRCM 103 / 132 M 4b		
	11,3	M8 (5m)	9,2	24	58,778	3526	IRCM 103 / 132 M 4c		
	12,7	M8 (5m)	9,2	27	51,907	3114	IRCM 103 / 132 M 4c		
	4,1	M7 (4m)	3	8,6	162,826	3186	IRCM 93 / 100 L 4b		
	4,5	M7 (4m)	4	9,5	146,946	3833	IRCM 93 / 112 M 4b		
	4,7	M7 (4m)	4	10	133,419	3480	IRCM 93 / 112 M 4b		
	6,1	M7 (4m)	5,5	13	111,602	4003	IRCM 93 / 132 S 4c		
	7,5	M7 (4m)	5,5	16	87,936	3154	IRCM 93 / 132 S 4c		
	8,5	M6 (3m)	7,5	18	79,841	3905	IRCM 93 / 132 M 4b		
	9,9	M6 (3m)	7,5	21	66,785	3266	IRCM 93 / 132 M 4b		
	11	M6 (3m)	7,5	23	61,444	3005	IRCM 93 / 132 M 4b		
	12	M6 (3m)	9,2	26	54,545	3272	IRCM 93 / 132 M 4c		
	15	M6 (3m)	11	31	44,753	3210	IRCM 93 / 160 M 4b		
	18	M6 (3m)	15	38	37,199	3639	IRCM 93 / 160 L 4a		
19	M6 (3m)	15	41	34,034	3329	IRCM 93 / 160 L 4a			
21	M6 (3m)	15	45	31,194	3051	IRCM 93 / 160 L 4a			



Vinç sistemleri kaldırma redüktörleri güç ve devir tabloları / Power and ratio table for hoisting applications / Tableau de classification des couples et rapports de réduction pour les applications de levage

D _T Tambur Çapı Drum Diameter Diamètre de l'arbre [mm]	V _h Kaldırma Hızı Lifting Speeds Vitesse de levage [m/min]	Vinç Sınıfı Crane Class Classification de l'application de levage ISO (FEM)	P ₁ Motor Gücü Power Puissance [kW]	n ₂ Çıkış Devri Output Speeds Vitesse de sortie [r.p.m]	i Tahvil Ratio Rapport de réduction	M ₂ Çıkış Momenti Output Torque Couple de sortie	Tip Type Typ		 kg
Ø170	1,1	M8 (5m)	1,1	8,6	162,826	1168	IRCM 93 / 90 S 4a		
	1,3	M8 (5m)	1,1	9,5	146,946	1054	IRCM 93 / 90 S 4a		
	1,3	M8 (5m)	1,1	10	133,419	957	IRCM 93 / 90 S 4a		
	1,7	M8 (5m)	1,5	13	111,602	1092	IRCM 93 / 90 L 4a		
	2,1	M8 (5m)	1,5	16	87,936	860	IRCM 93 / 90 L 4a		
	2,4	M8 (5m)	2,2	18	79,841	1145	IRCM 93 / 100 L 4a		
	2,8	M8 (5m)	2,2	21	66,785	958	IRCM 93 / 100 L 4a		
	3,1	M8 (5m)	2,2	23	61,444	882	IRCM 93 / 100 L 4a		
	3,5	M8 (5m)	3	26	54,545	1067	IRCM 93 / 100 L 4b		
	4,1	M8 (5m)	3	31	44,753	876	IRCM 93 / 100 L 4b		
	5,1	M8 (5m)	4	38	37,199	970	IRCM 93 / 112 M 4b		
	5,5	M8 (5m)	4	41	34,034	888	IRCM 93 / 112 M 4b		
	6,0	M8 (5m)	5,5	45	31,194	1119	IRCM 93 / 132 S 4c		
	1,3	M8 (5m)	1,1	10	133,509	958	IRCM 83 / 90 S 4a		
	1,6	M8 (5m)	1,5	12	121,711	1191	IRCM 83 / 90 L 4a		
	1,9	M8 (5m)	1,5	14	102,407	1002	IRCM 83 / 90 L 4a		
	2,0	M8 (5m)	1,5	15	92,330	903	IRCM 83 / 90 L 4a		
	2,5	M8 (5m)	2,2	19	75,613	1085	IRCM 83 / 100 L 4a		
	3,1	M8 (5m)	2,2	23	60,299	865	IRCM 83 / 100 L 4a		
	3,5	M8 (5m)	3	26	54,358	1063	IRCM 83 / 100 L 4b		
3,9	M8 (5m)	3	29	48,314	945	IRCM 83 / 100 L 4b			
4,7	M8 (5m)	4	35	39,796	1038	IRCM 83 / 112 M 4b			
5,6	M8 (5m)	4	42	33,003	861	IRCM 83 / 112 M 4b			
6,8	M8 (5m)	5,5	51	27,535	988	IRCM 83 / 132 S 4c			
Ø180	1,2	M8 (5m)	1,1	8,6	162,826	1168	IRCM 93 / 90 S 4a		
	1,3	M8 (5m)	1,1	9,5	146,946	1054	IRCM 93 / 90 S 4a		
	1,4	M8 (5m)	1,1	10	133,419	957	IRCM 93 / 90 S 4a		
	1,8	M8 (5m)	1,5	13	111,602	1092	IRCM 93 / 90 L 4a		
	2,3	M8 (5m)	2,2	16	87,936	1262	IRCM 93 / 100 L 4a		
	2,5	M8 (5m)	2,2	18	79,841	1145	IRCM 93 / 100 L 4a		
	3,0	M8 (5m)	2,2	21	66,785	958	IRCM 93 / 100 L 4a		
	3,2	M8 (5m)	3	23	61,444	1202	IRCM 93 / 100 L 4b		
	3,7	M8 (5m)	3	26	54,545	1067	IRCM 93 / 100 L 4b		
	4,4	M8 (5m)	4	31	44,753	1167	IRCM 93 / 112 M 4b		
	5,4	M8 (5m)	4	38	37,199	970	IRCM 93 / 112 M 4b		
	5,8	M8 (5m)	4	41	34,034	888	IRCM 93 / 112 M 4b		
	6,4	M8 (5m)	5,5	45	31,194	1119	IRCM 93 / 132 S 4c		
	1,4	M8 (5m)	1,1	10	133,509	958	IRCM 83 / 90 S 4a		
	1,7	M8 (5m)	1,5	12	121,711	1191	IRCM 83 / 90 L 4a		
	2,0	M8 (5m)	1,5	14	102,407	1002	IRCM 83 / 90 L 4a		
	2,1	M8 (5m)	1,5	15	92,330	903	IRCM 83 / 90 L 4a		
	2,7	M8 (5m)	2,2	19	75,613	1085	IRCM 83 / 100 L 4a		
	3,2	M8 (5m)	3	23	60,299	1180	IRCM 83 / 100 L 4b		
	3,7	M8 (5m)	3	26	54,358	1063	IRCM 83 / 100 L 4b		
4,1	M8 (5m)	3	29	48,314	945	IRCM 83 / 100 L 4b			
4,9	M8 (5m)	4	35	39,796	1038	IRCM 83 / 112 M 4b			
5,9	M8 (5m)	5,5	42	33,003	1184	IRCM 83 / 132 S 4c			
7,2	M8 (5m)	5,5	51	27,535	988	IRCM 83 / 132 S 4c			



D _T Tambur Çapı Drum Diameter <i>Diamètre de l'arbre</i> [mm]	V _h Kaldırma Hızı Lifting Speeds <i>Vitesse de levage</i> [m/min]	Vinç Sınıfı Crane Class <i>Classification de l'application de levage</i> ISO (FEM)	P ₁ Motor Gücü Power <i>Puissance</i> [kW]	n ₂ Çıkış Devri Output Speeds <i>Vitesse de sortie</i> [r.p.m]	i Tahvil Ratio <i>Rapport de réduction</i>	M ₂ Çıkış Momenti Output Torque <i>Couple de sortie</i>	Tip Type <i>Typ</i>		 kg
Ø190	1,3	M8 (5m)	1,1	8,6	162,826	1168	IRCM 93 / 90 S 4a		
	1,4	M8 (5m)	1,1	9,5	146,946	1054	IRCM 93 / 90 S 4a		
	1,5	M8 (5m)	1,1	10	133,419	957	IRCM 93 / 90 S 4a		
	1,9	M8 (5m)	1,5	13	111,602	1092	IRCM 93 / 90 L 4a		
	2,4	M8 (5m)	2,2	16	87,936	1262	IRCM 93 / 100 L 4a		
	2,7	M8 (5m)	2,2	18	79,841	1145	IRCM 93 / 100 L 4a		
	3,1	M8 (5m)	2,2	21	66,785	958	IRCM 93 / 100 L 4a		
	3,4	M8 (5m)	3	23	61,444	1202	IRCM 93 / 100 L 4b		
	3,9	M8 (5m)	3	26	54,545	1067	IRCM 93 / 100 L 4b		
	4,6	M8 (5m)	4	31	44,753	1167	IRCM 93 / 112 M 4b		
	5,7	M8 (5m)	4	38	37,199	970	IRCM 93 / 112 M 4b		
	6,1	M8 (5m)	5,5	41	34,034	1221	IRCM 93 / 132 S 4c		
	6,7	M8 (5m)	5,5	45	31,194	1119	IRCM 93 / 132 S 4c		
	1,5	M8 (5m)	1,1	10	133,509	958	IRCM 83 / 90 S 4a		
	1,8	M8 (5m)	1,5	12	121,711	1191	IRCM 83 / 90 L 4a		
	2,1	M8 (5m)	1,5	14	102,407	1002	IRCM 83 / 90 L 4a		
	2,2	M8 (5m)	2,2	15	92,330	1325	IRCM 83 / 100 L 4a		
	2,8	M8 (5m)	2,2	19	75,613	1085	IRCM 83 / 100 L 4a		
	3,4	M8 (5m)	3	23	60,299	1180	IRCM 83 / 100 L 4b		
	3,9	M8 (5m)	3	26	54,358	1063	IRCM 83 / 100 L 4b		
	4,3	M8 (5m)	3	29	48,314	945	IRCM 83 / 100 L 4b		
	5,2	M8 (5m)	4	35	39,796	1038	IRCM 83 / 112 M 4b		
6,3	M7 (4m)	5,5	42	33,003	1184	IRCM 83 / 132 S 4c			
7,6	M7 (4m)	5,5	51	27,535	988	IRCM 83 / 132 S 4c			
Ø200	1,4	M8 (5m)	1,1	8,6	162,826	1168	IRCM 93 / 90 S 4a		
	1,5	M8 (5m)	1,1	9,5	146,946	1054	IRCM 93 / 90 S 4a		
	1,6	M8 (5m)	1,1	10	133,419	957	IRCM 93 / 90 S 4a		
	2,0	M8 (5m)	1,5	13	111,602	1092	IRCM 93 / 90 L 4a		
	2,5	M8 (5m)	2,2	16	87,936	1262	IRCM 93 / 100 L 4a		
	2,8	M8 (5m)	2,2	18	79,841	1145	IRCM 93 / 100 L 4a		
	3,3	M8 (5m)	3	21	66,785	1307	IRCM 93 / 100 L 4b		
	3,6	M8 (5m)	3	23	61,444	1202	IRCM 93 / 100 L 4b		
	4,1	M8 (5m)	3	26	54,545	1067	IRCM 93 / 100 L 4b		
	4,9	M8 (5m)	4	31	44,753	1167	IRCM 93 / 112 M 4b		
	6,0	M8 (5m)	5,5	38	37,199	1334	IRCM 93 / 132 S 4c		
	6,4	M8 (5m)	5,5	41	34,034	1221	IRCM 93 / 132 S 4c		
	7,1	M8 (5m)	5,5	45	31,194	1119	IRCM 93 / 132 S 4c		
	1,6	M8 (5m)	1,1	10	133,509	958	IRCM 83 / 90 S 4a		
	1,9	M8 (5m)	1,5	12	121,711	1191	IRCM 83 / 90 L 4a		
	2,2	M8 (5m)	2,2	14	102,407	1469	IRCM 83 / 100 L 4a		
	2,4	M8 (5m)	2,2	15	92,330	1325	IRCM 83 / 100 L 4a		
	3,0	M8 (5m)	2,2	19	75,613	1085	IRCM 83 / 100 L 4a		
	3,6	M8 (5m)	3	23	60,299	1180	IRCM 83 / 100 L 4b		
	4,1	M8 (5m)	3	26	54,358	1063	IRCM 83 / 100 L 4b		
	4,6	M8 (5m)	4	29	48,314	1260	IRCM 83 / 112 M 4b		
	5,5	M7 (4m)	4	35	39,796	1038	IRCM 83 / 112 M 4b		
6,6	M7 (4m)	5,5	42	33,003	1184	IRCM 83 / 132 S 4c			
8,0	M7 (4m)	7,5	51	27,535	1347	IRCM 83 / 132 M 4b			



Vinç sistemleri kaldırma redüktörleri güç ve devir tabloları / Power and ratio table for hoisting applications / Tableau de classification des couples et rapports de réduction pour les applications de levage



D _T Tambur Çapı Drum Diameter Diamètre de l'arbre [mm]	V _h Kaldırma Hızı Lifting Speeds Vitesse de levage [m/min]	Vinç Sınıfı Crane Class Classification de l'application de levage ISO (FEM)	P ₁ Motor Gücü Power Puissance [kW]	n ₂ Çıkış Devri Output Speeds Vitesse de sortie [r.p.m]	i Tahvil Ratio Rapport de réduction	M ₂ Çıkış Momenti Output Torque Couple de sortie	Tip Type Typ			kg
Ø210	1,4	M8 (5m)	1,1	8,6	162,826	1168	IRCM 93 / 90 S 4a			
	1,6	M8 (5m)	1,1	9,5	146,946	1054	IRCM 93 / 90 S 4a			
	1,6	M8 (5m)	1,5	10	133,419	1305	IRCM 93 / 90 L 4a			
	2,1	M8 (5m)	1,5	13	111,602	1092	IRCM 93 / 90 L 4a			
	2,6	M8 (5m)	2,2	16	87,936	1262	IRCM 93 / 100 L 4a			
	3,0	M8 (5m)	2,2	18	79,841	1145	IRCM 93 / 100 L 4a			
	3,5	M8 (5m)	3	21	66,785	1307	IRCM 93 / 100 L 4b			
	3,8	M8 (5m)	3	23	61,444	1202	IRCM 93 / 100 L 4b			
	4,3	M8 (5m)	3	26	54,545	1067	IRCM 93 / 100 L 4b			
	5,1	M8 (5m)	4	31	44,753	1167	IRCM 93 / 112 M 4b			
	6,3	M8 (5m)	5,5	38	37,199	1334	IRCM 93 / 132 S 4c			
	6,8	M8 (5m)	5,5	41	34,034	1221	IRCM 93 / 132 S 4c			
	7,4	M8 (5m)	5,5	45	31,194	1119	IRCM 93 / 132 S 4c			
	1,6	M8 (5m)	1,5	10	133,509	1306	IRCM 83 / 90 L 4a			
	2,0	M8 (5m)	1,5	12	121,711	1191	IRCM 83 / 90 L 4a			
	2,3	M8 (5m)	2,2	14	102,407	1469	IRCM 83 / 100 L 4a			
	2,5	M8 (5m)	2,2	15	92,330	1325	IRCM 83 / 100 L 4a			
	3,1	M7 (4m)	2,2	19	75,613	1085	IRCM 83 / 100 L 4a			
	3,8	M7 (4m)	3	23	60,299	1180	IRCM 83 / 100 L 4b			
	4,3	M7 (4m)	3	26	54,358	1063	IRCM 83 / 100 L 4b			
4,8	M7 (4m)	4	29	48,314	1260	IRCM 83 / 112 M 4b				
5,8	M7 (4m)	4	35	39,796	1038	IRCM 83 / 112 M 4b				
6,9	M7 (4m)	5,5	42	33,003	1184	IRCM 83 / 132 S 4c				
8,4	M7 (4m)	7,5	51	27,535	1347	IRCM 83 / 132 M 4b				
Ø220	1,5	M8 (5m)	1,1	8,6	162,826	1168	IRCM 93 / 90 S 4a			
	1,6	M8 (5m)	1,5	9,5	146,946	1437	IRCM 93 / 90 L 4a			
	1,7	M8 (5m)	1,5	10	133,419	1305	IRCM 93 / 90 L 4a			
	2,2	M8 (5m)	2,2	13	111,602	1601	IRCM 93 / 100 L 4a			
	2,8	M8 (5m)	2,2	16	87,936	1262	IRCM 93 / 100 L 4a			
	3,1	M8 (5m)	2,2	18	79,841	1145	IRCM 93 / 100 L 4a			
	3,6	M8 (5m)	3	21	66,785	1307	IRCM 93 / 100 L 4b			
	4,0	M8 (5m)	3	23	61,444	1202	IRCM 93 / 100 L 4b			
	4,5	M8 (5m)	4	26	54,545	1423	IRCM 93 / 112 M 4b			
	5,4	M8 (5m)	4	31	44,753	1167	IRCM 93 / 112 M 4b			
	6,6	M8 (5m)	5,5	38	37,199	1334	IRCM 93 / 132 S 4c			
	7,1	M8 (5m)	5,5	41	34,034	1221	IRCM 93 / 132 S 4c			
	7,8	M8 (5m)	5,5	45	31,194	1119	IRCM 93 / 132 S 4c			
	1,7	M7 (4m)	1,5	10	133,509	1306	IRCM 83 / 90 L 4a			
	2,1	M7 (4m)	1,5	12	121,711	1191	IRCM 83 / 90 L 4a			
	2,4	M7 (4m)	2,2	14	102,407	1469	IRCM 83 / 100 L 4a			
	2,6	M7 (4m)	2,2	15	92,330	1325	IRCM 83 / 100 L 4a			
	3,3	M7 (4m)	3	19	75,613	1479	IRCM 83 / 100 L 4b			
	4,0	M7 (4m)	3	23	60,299	1180	IRCM 83 / 100 L 4b			
	4,5	M7 (4m)	4	26	54,358	1418	IRCM 83 / 112 M 4b			
5,0	M7 (4m)	4	29	48,314	1260	IRCM 83 / 112 M 4b				
6,0	M7 (4m)	5,5	35	39,796	1427	IRCM 83 / 132 S 4c				
7,3	M7 (4m)	5,5	42	33,003	1184	IRCM 83 / 132 S 4c				
8,8	M7 (4m)	7,5	51	27,535	1347	IRCM 83 / 132 M 4b				





D _T Tambur Çapı Drum Diameter <i>Diamètre de l'arbre</i> [mm]	V _h Kaldırma Hızı Lifting Speeds <i>Vitesse de levage</i> [m/min]	Vinç Sınıfı Crane Class <i>Classification de l'application de levage</i> ISO (FEM)	P ₁ Motor Gücü Power <i>Puissance</i> [kW]	n ₂ Çıkış Devri Output Speeds <i>Vitesse de sortie</i> [r.p.m]	i Tahvil Ratio <i>Rapport de réduction</i>	M ₂ Çıkış Momenti Output Torque <i>Couple de sortie</i>	Tip Type <i>Typ</i>		 kg
Ø230	1,6	M8 (5m)	1,1	8,6	162,826	1168	IRCM 93 / 90 S 4a		
	1,7	M8 (5m)	1,5	9,5	146,946	1437	IRCM 93 / 90 L 4a		
	1,8	M8 (5m)	1,5	10	133,419	1305	IRCM 93 / 90 L 4a		
	2,3	M8 (5m)	2,2	13	111,602	1601	IRCM 93 / 100 L 4a		
	2,9	M8 (5m)	2,2	16	87,936	1262	IRCM 93 / 100 L 4a		
	3,2	M8 (5m)	3	18	79,841	1562	IRCM 93 / 100 L 4b		
	3,8	M8 (5m)	3	21	66,785	1307	IRCM 93 / 100 L 4b		
	4,2	M8 (5m)	3	23	61,444	1202	IRCM 93 / 100 L 4b		
	4,7	M8 (5m)	4	26	54,545	1423	IRCM 93 / 112 M 4b		
	5,6	M8 (5m)	4	31	44,753	1167	IRCM 93 / 112 M 4b		
	6,9	M8 (5m)	5,5	38	37,199	1334	IRCM 93 / 132 S 4c		
	7,4	M8 (5m)	5,5	41	34,034	1221	IRCM 93 / 132 S 4c		
	8,1	M8 (5m)	7,5	45	31,194	1526	IRCM 93 / 132 M 4b		
	1,8	M7 (4m)	1,5	10	133,509	1306	IRCM 83 / 90 L 4a		
	2,2	M7 (4m)	1,5	12	121,711	1191	IRCM 83 / 90 L 4a		
	2,5	M7 (4m)	2,2	14	102,407	1469	IRCM 83 / 100 L 4a		
	2,7	M7 (4m)	2,2	15	92,330	1325	IRCM 83 / 100 L 4a		
	3,4	M7 (4m)	3	19	75,613	1479	IRCM 83 / 100 L 4b		
	4,2	M7 (4m)	3	23	60,299	1180	IRCM 83 / 100 L 4b		
	4,7	M7 (4m)	4	26	54,358	1418	IRCM 83 / 112 M 4b		
	5,2	M7 (4m)	4	29	48,314	1260	IRCM 83 / 112 M 4b		
	6,3	M7 (4m)	5,5	35	39,796	1427	IRCM 83 / 132 S 4c		
7,6	M7 (4m)	5,5	42	33,003	1184	IRCM 83 / 132 S 4c			
9,2	M7 (4m)	7,5	51	27,535	1347	IRCM 83 / 132 M 4b			
Ø240	1,6	M8 (5m)	1,5	8,6	162,826	1593	IRCM 93 / 90 L 4a		
	1,8	M8 (5m)	1,5	9,5	146,946	1437	IRCM 93 / 90 L 4a		
	1,9	M8 (5m)	1,5	10	133,419	1305	IRCM 93 / 90 L 4a		
	2,4	M8 (5m)	2,2	13	111,602	1601	IRCM 93 / 100 L 4a		
	3,0	M8 (5m)	2,2	16	87,936	1262	IRCM 93 / 100 L 4a		
	3,4	M8 (5m)	3	18	79,841	1562	IRCM 93 / 100 L 4b		
	4,0	M8 (5m)	3	21	66,785	1307	IRCM 93 / 100 L 4b		
	4,3	M8 (5m)	3	23	61,444	1202	IRCM 93 / 100 L 4b		
	4,9	M8 (5m)	4	26	54,545	1423	IRCM 93 / 112 M 4b		
	5,8	M8 (5m)	5,5	31	44,753	1605	IRCM 93 / 132 S 4c		
	7,2	M8 (5m)	5,5	38	37,199	1334	IRCM 93 / 132 S 4c		
	7,7	M8 (5m)	5,5	41	34,034	1221	IRCM 93 / 132 S 4c		
	8,5	M8 (5m)	7,5	45	31,194	1526	IRCM 93 / 132 M 4b		
	1,9	M7 (4m)	1,5	10	133,509	1306	IRCM 83 / 90 L 4a		
	2,3	M7 (4m)	2,2	12	121,711	1746	IRCM 83 / 100 L 4a		
	2,6	M7 (4m)	2,2	14	102,407	1469	IRCM 83 / 100 L 4a		
	2,8	M7 (4m)	2,2	15	92,330	1325	IRCM 83 / 100 L 4a		
	3,6	M7 (4m)	3	19	75,613	1479	IRCM 83 / 100 L 4b		
	4,3	M7 (4m)	3	23	60,299	1180	IRCM 83 / 100 L 4b		
	4,9	M7 (4m)	4	26	54,358	1418	IRCM 83 / 112 M 4b		
	5,5	M7 (4m)	4	29	48,314	1260	IRCM 83 / 112 M 4b		
	6,6	M7 (4m)	5,5	35	39,796	1427	IRCM 83 / 132 S 4c		
7,9	M6 (3m)	5,5	42	33,003	1184	IRCM 83 / 132 S 4c			
9,6	M6 (3m)	7,5	51	27,535	1347	IRCM 83 / 132 M 4b			



Vinç sistemleri kaldırma redüktörleri güç ve devir tabloları / Power and ratio table for hoisting applications / Tableau de classification des couples et rapports de réduction pour les applications de levage



D _T Tambur Çapı Drum Diameter Diamètre de l'arbre [mm]	V _h Kaldırma Hızı Lifting Speeds Vitesse de levage [m/min]	Vinç Sınıfı Crane Class Classification de l'application de levage ISO (FEM)	P ₁ Motor Gücü Power Puissance [kW]	n ₂ Çıkış Devri Output Speeds Vitesse de sortie [r.p.m]	i Tahvil Ratio Rapport de réduction	M ₂ Çıkış Momenti Output Torque Couple de sortie	Tip Type Typ		 kg
Ø110	0,7	M8 (5m)	0,55	12	120,792	433	IRCM 73 / 80 M 4a		
	0,7	M8 (5m)	0,55	13	107,423	385	IRCM 73 / 80 M 4a		
	0,9	M8 (5m)	0,75	15	96,194	470	IRCM 73 / 80 M 4b		
	0,9	M8 (5m)	0,75	16	86,628	424	IRCM 73 / 80 M 4b		
	1,1	M8 (5m)	1,1	19	73,889	530	IRCM 73 / 90 S 4a		
	1,2	M8 (5m)	1,1	21	65,252	468	IRCM 73 / 90 S 4a		
	1,4	M8 (5m)	1,1	24	57,996	416	IRCM 73 / 90 S 4a		
	1,6	M8 (5m)	1,1	27	51,846	372	IRCM 73 / 90 S 4a		
	1,9	M8 (5m)	1,5	33	41,848	409	IRCM 73 / 90 L 4a		
	2,2	M8 (5m)	2,2	39	35,564	510	IRCM 73 / 100 L 4a		
	2,5	M8 (5m)	2,2	44	32,098	461	IRCM 73 / 100 L 4a		
	3,1	M8 (5m)	2,2	53	26,291	377	IRCM 73 / 100 L 4a		
Ø120	3,4	M8 (5m)	3	59	23,834	466	IRCM 73 / 100 L 4b		
	0,8	M8 (5m)	0,55	12	120,792	433	IRCM 73 / 80 M 4a		
	0,8	M8 (5m)	0,75	13	107,423	525	IRCM 73 / 80 M 4b		
	0,9	M8 (5m)	0,75	15	96,194	470	IRCM 73 / 80 M 4b		
	1,0	M8 (5m)	0,75	16	86,628	424	IRCM 73 / 80 M 4b		
	1,2	M8 (5m)	1,1	19	73,889	530	IRCM 73 / 90 S 4a		
	1,3	M8 (5m)	1,1	21	65,252	468	IRCM 73 / 90 S 4a		
	1,5	M8 (5m)	1,1	24	57,996	416	IRCM 73 / 90 S 4a		
	1,7	M8 (5m)	1,5	27	51,846	507	IRCM 73 / 90 L 4a		
	2,1	M8 (5m)	1,5	33	41,848	409	IRCM 73 / 90 L 4a		
	2,4	M8 (5m)	2,2	39	35,564	510	IRCM 73 / 100 L 4a		
	2,8	M8 (5m)	2,2	44	32,098	461	IRCM 73 / 100 L 4a		
Ø130	3,3	M8 (5m)	3	53	26,291	514	IRCM 73 / 100 L 4b		
	3,7	M8 (5m)	3	59	23,834	466	IRCM 73 / 100 L 4b		
	0,8	M8 (5m)	0,75	12	120,792	591	IRCM 73 / 80 M 4b		
	0,9	M8 (5m)	0,75	13	107,423	525	IRCM 73 / 80 M 4b		
	1,0	M8 (5m)	0,75	15	96,194	470	IRCM 73 / 80 M 4b		
	1,1	M8 (5m)	0,75	16	86,628	424	IRCM 73 / 80 M 4b		
	1,3	M8 (5m)	1,1	19	73,889	530	IRCM 73 / 90 S 4a		
	1,4	M8 (5m)	1,1	21	65,252	468	IRCM 73 / 90 S 4a		
	1,6	M8 (5m)	1,5	24	57,996	567	IRCM 73 / 90 L 4a		
	1,8	M8 (5m)	1,5	27	51,846	507	IRCM 73 / 90 L 4a		
	2,2	M8 (5m)	2,2	33	41,848	600	IRCM 73 / 100 L 4a		
	2,7	M8 (5m)	2,2	39	35,564	510	IRCM 73 / 100 L 4a		
Ø140	3,0	M8 (5m)	2,2	44	32,098	461	IRCM 73 / 100 L 4a		
	3,6	M8 (5m)	3	53	26,291	514	IRCM 73 / 100 L 4b		
	4,0	M8 (5m)	3	59	23,834	466	IRCM 73 / 100 L 4b		
	0,9	M8 (5m)	0,75	12	120,792	591	IRCM 73 / 80 M 4b		
	1,0	M8 (5m)	0,75	13	107,423	525	IRCM 73 / 80 M 4b		
	1,1	M8 (5m)	1,1	15	96,194	690	IRCM 73 / 90 S 4a		
	1,2	M8 (5m)	1,1	16	86,628	621	IRCM 73 / 90 S 4a		
	1,4	M8 (5m)	1,1	19	73,889	530	IRCM 73 / 90 S 4a		
	1,5	M8 (5m)	1,1	21	65,252	468	IRCM 73 / 90 S 4a		
	1,8	M8 (5m)	1,5	24	57,996	567	IRCM 73 / 90 L 4a		
	2,0	M8 (5m)	1,5	27	51,846	507	IRCM 73 / 90 L 4a		
	2,4	M8 (5m)	2,2	33	41,848	600	IRCM 73 / 100 L 4a		
2,9	M8 (5m)	2,2	39	35,564	510	IRCM 73 / 100 L 4a			
3,2	M8 (5m)	3	44	32,098	628	IRCM 73 / 100 L 4b			
3,9	M8 (5m)	3	53	26,291	514	IRCM 73 / 100 L 4b			
4,3	M8 (5m)	3	59	23,834	466	IRCM 73 / 100 L 4b			





D _T Tambur Çapı Drum Diameter <i>Diamètre de l'arbre</i> [mm]	V _h Kaldırma Hızı Lifting Speeds <i>Vitesse de levage</i> [m/min]	Vinç Sınıfı Crane Class <i>Classification de l'application de levage</i> ISO (FEM)	P ₁ Motor Gücü Power <i>Puissance</i> [kW]	n ₂ Çıkış Devri Output Speeds <i>Vitesse de sortie</i> [r.p.m]	i Tahvil Ratio <i>Rapport de réduction</i>	M ₂ Çıkış Momenti Output Torque <i>Couple de sortie</i>	Tip Type <i>Typ</i>		 kg
Ø150	0,9	M8 (5m)	0,75	12	120,792	591	IRCM 73 / 80 M 4b		
	1,0	M8 (5m)	0,75	13	107,423	525	IRCM 73 / 80 M 4b		
	1,2	M8 (5m)	1,1	15	96,194	690	IRCM 73 / 90 S 4a		
	1,3	M8 (5m)	1,1	16	86,628	621	IRCM 73 / 90 S 4a		
	1,5	M8 (5m)	1,1	19	73,889	530	IRCM 73 / 90 S 4a		
	1,6	M8 (5m)	1,5	21	65,252	638	IRCM 73 / 90 L 4a		
	1,9	M8 (5m)	1,5	24	57,996	567	IRCM 73 / 90 L 4a		
	2,1	M8 (5m)	1,5	27	51,846	507	IRCM 73 / 90 L 4a		
	2,6	M8 (5m)	2,2	33	41,848	600	IRCM 73 / 100 L 4a		
	3,1	M8 (5m)	2,2	39	35,564	510	IRCM 73 / 100 L 4a		
	3,5	M8 (5m)	3	44	32,098	628	IRCM 73 / 100 L 4b		
	4,2	M7 (4m)	3	53	26,291	514	IRCM 73 / 100 L 4b		
	4,6	M7 (4m)	4	59	23,834	622	IRCM 73 / 112 M 4b		
Ø160	1,0	M8 (5m)	0,75	12	120,792	591	IRCM 73 / 80 M 4b		
	1,1	M8 (5m)	0,75	13	107,423	525	IRCM 73 / 80 M 4b		
	1,3	M8 (5m)	1,1	15	96,194	690	IRCM 73 / 90 S 4a		
	1,3	M8 (5m)	1,1	16	86,628	621	IRCM 73 / 90 S 4a		
	1,6	M8 (5m)	1,1	19	73,889	530	IRCM 73 / 90 S 4a		
	1,8	M8 (5m)	1,5	21	65,252	638	IRCM 73 / 90 L 4a		
	2,0	M8 (5m)	1,5	24	57,996	567	IRCM 73 / 90 L 4a		
	2,3	M8 (5m)	2,2	27	51,846	744	IRCM 73 / 100 L 4a		
	2,8	M8 (5m)	2,2	33	41,848	600	IRCM 73 / 100 L 4a		
	3,3	M7 (4m)	3	39	35,564	696	IRCM 73 / 100 L 4b		
	3,7	M7 (4m)	3	44	32,098	628	IRCM 73 / 100 L 4b		
	4,4	M7 (4m)	4	53	26,291	686	IRCM 73 / 112 M 4b		
	4,9	M7 (4m)	4	59	23,834	622	IRCM 73 / 112 M 4b		
Ø170	1,1	M8 (5m)	0,75	12	120,792	591	IRCM 73 / 80 M 4b		
	1,2	M7 (4m)	1,1	13	107,423	771	IRCM 73 / 90 S 4a		
	1,3	M7 (4m)	1,1	15	96,194	690	IRCM 73 / 90 S 4a		
	1,4	M7 (4m)	1,1	16	86,628	621	IRCM 73 / 90 S 4a		
	1,7	M7 (4m)	1,5	19	73,889	723	IRCM 73 / 90 L 4a		
	1,9	M7 (4m)	1,5	21	65,252	638	IRCM 73 / 90 L 4a		
	2,1	M7 (4m)	1,5	24	57,996	567	IRCM 73 / 90 L 4a		
	2,4	M7 (4m)	2,2	27	51,846	744	IRCM 73 / 100 L 4a		
	2,9	M7 (4m)	2,2	33	41,848	600	IRCM 73 / 100 L 4a		
	3,5	M7 (4m)	3	39	35,564	696	IRCM 73 / 100 L 4b		
	3,9	M7 (4m)	3	44	32,098	628	IRCM 73 / 100 L 4b		
	4,7	M7 (4m)	4	53	26,291	686	IRCM 73 / 112 M 4b		
	5,2	M7 (4m)	4	59	23,834	622	IRCM 73 / 112 M 4b		
Ø180	1,1	M7 (4m)	1,1	12	120,792	866	IRCM 73 / 90 S 4a		
	1,2	M7 (4m)	1,1	13	107,423	771	IRCM 73 / 90 S 4a		
	1,4	M7 (4m)	1,1	15	96,194	690	IRCM 73 / 90 S 4a		
	1,5	M7 (4m)	1,1	16	86,628	621	IRCM 73 / 90 S 4a		
	1,8	M7 (4m)	1,5	19	73,889	723	IRCM 73 / 90 L 4a		
	2,0	M7 (4m)	1,5	21	65,252	638	IRCM 73 / 90 L 4a		
	2,3	M7 (4m)	2,2	24	57,996	832	IRCM 73 / 100 L 4a		
	2,5	M7 (4m)	2,2	27	51,846	744	IRCM 73 / 100 L 4a		
	3,1	M7 (4m)	2,2	33	41,848	600	IRCM 73 / 100 L 4a		
	3,7	M7 (4m)	3	39	35,564	696	IRCM 73 / 100 L 4b		
	4,1	M7 (4m)	3	44	32,098	628	IRCM 73 / 100 L 4b		
	5,0	M7 (4m)	4	53	26,291	686	IRCM 73 / 112 M 4b		
	5,6	M7 (4m)	4	59	23,834	622	IRCM 73 / 112 M 4b		



Vinç sistemleri kaldırma redüktörleri güç ve devir tabloları / Power and ratio table for hoisting applications / Tableau de classification des couples et rapports de réduction pour les applications de levage



D _T Tambur Çapı Drum Diameter <i>Diamètre de l'arbre</i> [mm]	V _h Kaldırma Hızı Lifting Speeds <i>Vitesse de levage</i> [m/min]	Vinç Sınıfı Crane Class <i>Classification de l'application de levage</i> ISO (FEM)	P ₁ Motor Gücü Power <i>Puissance</i> [kW]	n ₂ Çıkış Devri Output Speeds <i>Vitesse de sortie</i> [r.p.m]	i Tahvil Ratio <i>Rapport de réduction</i>	M ₂ Çıkış Momenti Output Torque <i>Couple de sortie</i>	Tip Type <i>Typ</i>		 kg
Ø110	0,5	M8 (5m)	0,37	12	120,792	291	IRCM 73 / 71 M 4b		
	0,6	M8 (5m)	0,55	13	107,423	385	IRCM 73 / 80 M 4a		
	0,6	M8 (5m)	0,55	15	96,194	345	IRCM 73 / 80 M 4a		
	0,7	M8 (5m)	0,55	16	86,628	311	IRCM 73 / 80 M 4a		
	0,8	M8 (5m)	0,75	19	73,889	361	IRCM 73 / 80 M 4b		
	0,9	M8 (5m)	0,75	21	65,252	319	IRCM 73 / 80 M 4b		
	1,0	M8 (5m)	0,75	24	57,996	284	IRCM 73 / 80 M 4b		
	1,2	M8 (5m)	1,1	27	51,846	372	IRCM 73 / 90 S 4a		
	1,4	M8 (5m)	1,1	33	41,848	300	IRCM 73 / 90 S 4a		
	1,7	M8 (5m)	1,5	39	35,564	348	IRCM 73 / 90 L 4a		
	1,9	M8 (5m)	1,5	44	32,098	314	IRCM 73 / 90 L 4a		
	2,3	M8 (5m)	2,2	53	26,291	377	IRCM 73 / 100 L 4a		
2,5	M8 (5m)	2,2	59	23,834	342	IRCM 73 / 100 L 4a			
Ø120	0,6	M8 (5m)	0,55	12	120,792	433	IRCM 73 / 80 M 4a		
	0,6	M8 (5m)	0,55	13	107,423	385	IRCM 73 / 80 M 4a		
	0,7	M8 (5m)	0,55	15	96,194	345	IRCM 73 / 80 M 4a		
	0,8	M8 (5m)	0,55	16	86,628	311	IRCM 73 / 80 M 4a		
	0,9	M8 (5m)	0,75	19	73,889	361	IRCM 73 / 80 M 4b		
	1,0	M8 (5m)	0,75	21	65,252	319	IRCM 73 / 80 M 4b		
	1,1	M8 (5m)	1,1	24	57,996	416	IRCM 73 / 90 S 4a		
	1,3	M8 (5m)	1,1	27	51,846	372	IRCM 73 / 90 S 4a		
	1,6	M8 (5m)	1,1	33	41,848	300	IRCM 73 / 90 S 4a		
	1,8	M8 (5m)	1,5	39	35,564	348	IRCM 73 / 90 L 4a		
	2,1	M8 (5m)	1,5	44	32,098	314	IRCM 73 / 90 L 4a		
	2,5	M8 (5m)	2,2	53	26,291	377	IRCM 73 / 100 L 4a		
2,8	M8 (5m)	2,2	59	23,834	342	IRCM 73 / 100 L 4a			
Ø130	0,6	M8 (5m)	0,55	12	120,792	433	IRCM 73 / 80 M 4a		
	0,7	M8 (5m)	0,55	13	107,423	385	IRCM 73 / 80 M 4a		
	0,8	M8 (5m)	0,55	15	96,194	345	IRCM 73 / 80 M 4a		
	0,8	M8 (5m)	0,75	16	86,628	424	IRCM 73 / 80 M 4b		
	1,0	M8 (5m)	0,75	19	73,889	361	IRCM 73 / 80 M 4b		
	1,1	M8 (5m)	0,75	21	65,252	319	IRCM 73 / 80 M 4b		
	1,2	M8 (5m)	1,1	24	57,996	416	IRCM 73 / 90 S 4a		
	1,4	M8 (5m)	1,1	27	51,846	372	IRCM 73 / 90 S 4a		
	1,7	M8 (5m)	1,5	33	41,848	409	IRCM 73 / 90 L 4a		
	2,0	M8 (5m)	1,5	39	35,564	348	IRCM 73 / 90 L 4a		
	2,2	M8 (5m)	2,2	44	32,098	461	IRCM 73 / 100 L 4a		
	2,7	M8 (5m)	2,2	53	26,291	377	IRCM 73 / 100 L 4a		
3,0	M8 (5m)	2,2	59	23,834	342	IRCM 73 / 100 L 4a			
Ø140	0,7	M8 (5m)	0,55	12	120,792	433	IRCM 73 / 80 M 4a		
	0,7	M8 (5m)	0,55	13	107,423	385	IRCM 73 / 80 M 4a		
	0,8	M8 (5m)	0,75	15	96,194	470	IRCM 73 / 80 M 4b		
	0,9	M8 (5m)	0,75	16	86,628	424	IRCM 73 / 80 M 4b		
	1,0	M8 (5m)	0,75	19	73,889	361	IRCM 73 / 80 M 4b		
	1,2	M8 (5m)	1,1	21	65,252	468	IRCM 73 / 90 S 4a		
	1,3	M8 (5m)	1,1	24	57,996	416	IRCM 73 / 90 S 4a		
	1,5	M8 (5m)	1,1	27	51,846	372	IRCM 73 / 90 S 4a		
	1,8	M8 (5m)	1,5	33	41,848	409	IRCM 73 / 90 L 4a		
	2,1	M8 (5m)	1,5	39	35,564	348	IRCM 73 / 90 L 4a		
	2,4	M8 (5m)	2,2	44	32,098	461	IRCM 73 / 100 L 4a		
	2,9	M8 (5m)	2,2	53	26,291	377	IRCM 73 / 100 L 4a		
3,2	M8 (5m)	3	59	23,834	466	IRCM 73 / 100 L 4b			



D _T Tambur Çapı Drum Diameter <i>Diamètre de l'arbre</i> [mm]	V _h Kaldırma Hızı Lifting Speeds <i>Vitesse de levage</i> [m/min]	Vinç Sınıfı Crane Class <i>Classification de l'application de levage</i> ISO (FEM)	P ₁ Motor Gücü Power <i>Puissance</i> [kW]	n ₂ Çıkış Devri Output Speeds <i>Vitesse de sortie</i> [r.p.m]	i Tahvil Ratio <i>Rapport de réduction</i>	M ₂ Çıkış Momenti Output Torque <i>Couple de sortie</i>	Tip Type <i>Typ</i>		 kg
Ø150	0,7	M8 (5m)	0,55	12	120,792	433	IRCM 73 / 80 M 4a		
	0,8	M8 (5m)	0,55	13	107,423	385	IRCM 73 / 80 M 4a		
	0,9	M8 (5m)	0,75	15	96,194	470	IRCM 73 / 80 M 4b		
	0,9	M8 (5m)	0,75	16	86,628	424	IRCM 73 / 80 M 4b		
	1,1	M8 (5m)	1,1	19	73,889	530	IRCM 73 / 90 S 4a		
	1,2	M8 (5m)	1,1	21	65,252	468	IRCM 73 / 90 S 4a		
	1,4	M8 (5m)	1,1	24	57,996	416	IRCM 73 / 90 S 4a		
	1,6	M8 (5m)	1,1	27	51,846	372	IRCM 73 / 90 S 4a		
	1,9	M8 (5m)	1,5	33	41,848	409	IRCM 73 / 90 L 4a		
	2,3	M8 (5m)	2,2	39	35,564	510	IRCM 73 / 100 L 4a		
	2,6	M8 (5m)	2,2	44	32,098	461	IRCM 73 / 100 L 4a		
	3,1	M8 (5m)	2,2	53	26,291	377	IRCM 73 / 100 L 4a		
	3,5	M8 (5m)	3	59	23,834	466	IRCM 73 / 100 L 4b		
Ø160	0,8	M8 (5m)	0,55	12	120,792	433	IRCM 73 / 80 M 4a		
	0,8	M8 (5m)	0,75	13	107,423	525	IRCM 73 / 80 M 4b		
	0,9	M8 (5m)	0,75	15	96,194	470	IRCM 73 / 80 M 4b		
	1,0	M8 (5m)	0,75	16	86,628	424	IRCM 73 / 80 M 4b		
	1,2	M8 (5m)	1,1	19	73,889	530	IRCM 73 / 90 S 4a		
	1,3	M8 (5m)	1,1	21	65,252	468	IRCM 73 / 90 S 4a		
	1,5	M8 (5m)	1,1	24	57,996	416	IRCM 73 / 90 S 4a		
	1,7	M8 (5m)	1,5	27	51,846	507	IRCM 73 / 90 L 4a		
	2,1	M8 (5m)	1,5	33	41,848	409	IRCM 73 / 90 L 4a		
	2,4	M8 (5m)	2,2	39	35,564	510	IRCM 73 / 100 L 4a		
	2,8	M8 (5m)	2,2	44	32,098	461	IRCM 73 / 100 L 4a		
	3,3	M8 (5m)	3	53	26,291	514	IRCM 73 / 100 L 4b		
	3,7	M8 (5m)	3	59	23,834	466	IRCM 73 / 100 L 4b		
Ø170	0,8	M8 (5m)	0,75	12	120,792	591	IRCM 73 / 80 M 4b		
	0,9	M8 (5m)	0,75	13	107,423	525	IRCM 73 / 80 M 4b		
	1,0	M8 (5m)	0,75	15	96,194	470	IRCM 73 / 80 M 4b		
	1,1	M8 (5m)	0,75	16	86,628	424	IRCM 73 / 80 M 4b		
	1,3	M8 (5m)	1,1	19	73,889	530	IRCM 73 / 90 S 4a		
	1,4	M8 (5m)	1,1	21	65,252	468	IRCM 73 / 90 S 4a		
	1,6	M8 (5m)	1,5	24	57,996	567	IRCM 73 / 90 L 4a		
	1,8	M8 (5m)	1,5	27	51,846	507	IRCM 73 / 90 L 4a		
	2,2	M8 (5m)	2,2	33	41,848	600	IRCM 73 / 100 L 4a		
	2,6	M8 (5m)	2,2	39	35,564	510	IRCM 73 / 100 L 4a		
	2,9	M8 (5m)	2,2	44	32,098	461	IRCM 73 / 100 L 4a		
	3,5	M8 (5m)	3	53	26,291	514	IRCM 73 / 100 L 4b		
	3,9	M8 (5m)	3	59	23,834	466	IRCM 73 / 100 L 4b		
Ø180	0,8	M8 (5m)	0,75	12	120,792	591	IRCM 73 / 80 M 4b		
	0,9	M8 (5m)	0,75	13	107,423	525	IRCM 73 / 80 M 4b		
	1,1	M8 (5m)	0,75	15	96,194	470	IRCM 73 / 80 M 4b		
	1,1	M8 (5m)	1,1	16	86,628	621	IRCM 73 / 90 S 4a		
	1,3	M8 (5m)	1,1	19	73,889	530	IRCM 73 / 90 S 4a		
	1,5	M8 (5m)	1,1	21	65,252	468	IRCM 73 / 90 S 4a		
	1,7	M8 (5m)	1,5	24	57,996	567	IRCM 73 / 90 L 4a		
	1,9	M8 (5m)	1,5	27	51,846	507	IRCM 73 / 90 L 4a		
	2,3	M8 (5m)	2,2	33	41,848	600	IRCM 73 / 100 L 4a		
	2,8	M8 (5m)	2,2	39	35,564	510	IRCM 73 / 100 L 4a		
	3,1	M8 (5m)	2,2	44	32,098	461	IRCM 73 / 100 L 4a		
	3,7	M8 (5m)	3	53	26,291	514	IRCM 73 / 100 L 4b		
	4,2	M8 (5m)	3	59	23,834	466	IRCM 73 / 100 L 4b		



Vinç sistemleri kaldırma redüktörleri güç ve devir tabloları / Power and ratio table for hoisting applications / Tableau de classification des couples et rapports de réduction pour les applications de levage



D _T Tambur Çapı Drum Diameter <i>Diamètre de l'arbre</i> [mm]	V _h Kaldırma Hızı Lifting Speeds <i>Vitesse de levage</i> [m/min]	Vinç Sınıfı Crane Class <i>Classification de l'application de levage</i> ISO (FEM)	P ₁ Motor Gücü Power <i>Puissance</i> [kW]	n ₂ Çıkış Devri Output Speeds <i>Vitesse de sortie</i> [r.p.m]	i Tahvil Ratio <i>Rapport de réduction</i>	M ₂ Çıkış Momenti Output Torque <i>Couple de sortie</i>	Tip Type <i>Typ</i>		 kg
Ø300	6,7	M8 (5m)	7,5	7,1	198,333	9700	IRCM 123 / 132 M 4b		
	8,2	M8 (5m)	7,5	8,7	161,000	7874	IRCM 123 / 132 M 4b		
	9,4	M7 (4m)	9,2	10	134,473	8068	IRCM 123 / 132 M 4c		
	11	M7 (4m)	11	12	118,333	8489	IRCM 123 / 160 M 4b		
	12	M7 (4m)	11	13	105,000	7532	IRCM 123 / 160 M 4b		
	14	M7 (4m)	15	15	93,800	9175	IRCM 123 / 160 L 4a		
	16	M7 (4m)	15	17	84,259	8242	IRCM 123 / 160 L 4a		
	18	M7 (4m)	18,5	19	73,179	8829	IRCM 123 / 180 M 4b		
	21	M7 (4m)	18,5	22	64,396	7769	IRCM 123 / 180 M 4b		
	24	M7 (4m)	22	25	57,140	8198	IRCM 123 / 180 L 4b		
	25	M7 (4m)	22	27	51,045	7323	IRCM 123 / 180 L 4b		
	29	M7 (4m)	30	31	45,853	8971	IRCM 123 / 200 L 4c		
	6,6	M6 (3m)	7,5	7,0	199,476	9756	IRCM 103 / 132 M 4b		
	7,4	M6 (3m)	7,5	7,9	177,284	8671	IRCM 103 / 132 M 4b		
	9,2	M6 (3m)	9,2	10	143,552	8613	IRCM 103 / 132 M 4c		
	11,3	M6 (3m)	11	12	119,126	8545	IRCM 103 / 160 M 4b		
	12,2	M6 (3m)	11	13	109,276	7839	IRCM 103 / 160 M 4b		
	14,1	M6 (3m)	15	15	95,896	9380	IRCM 103 / 160 L 4a		
	17,0	M6 (3m)	15	18	78,692	7698	IRCM 103 / 160 L 4a		
	17,9	M6 (3m)	18,5	19	71,869	8671	IRCM 103 / 180 M 4b		
22,6	M6 (3m)	22	24	58,778	8433	IRCM 103 / 180 L 4b			
25,4	M6 (3m)	22	27	51,907	7447	IRCM 103 / 180 L 4b			
Ø310	6,8	M6 (3m)	7,5	7,0	199,476	9756	IRCM 103 / 132 M 4b		
	7,7	M6 (3m)	7,5	7,9	177,284	8671	IRCM 103 / 132 M 4b		
	9,5	M6 (3m)	9,2	10	143,552	8613	IRCM 103 / 132 M 4c		
	11,7	M6 (3m)	11	12	119,126	8545	IRCM 103 / 160 M 4b		
	12,7	M6 (3m)	11	13	109,276	7839	IRCM 103 / 160 M 4b		
	14,6	M6 (3m)	15	15	95,896	9380	IRCM 103 / 160 L 4a		
	17,5	M6 (3m)	18,5	18	78,692	9494	IRCM 103 / 180 M 4b		
	18,5	M6 (3m)	18,5	19	71,869	8671	IRCM 103 / 180 M 4b		
	23,4	M6 (3m)	22	24	58,778	8433	IRCM 103 / 180 L 4b		
	26,3	M5 (2m)	30	27	51,907	10155	IRCM 103 / 200 L 4c		
Ø320	7,1	M7 (4m)	7,5	7,1	198,333	9700	IRCM 123 / 132 M 4b		
	8,7	M7 (4m)	9,2	8,7	161,000	9659	IRCM 123 / 132 M 4c		
	10	M7 (4m)	9,2	10	134,473	8068	IRCM 123 / 132 M 4c		
	12	M7 (4m)	11	12	118,333	8489	IRCM 123 / 160 M 4b		
	13	M7 (4m)	15	13	105,000	10271	IRCM 123 / 160 L 4a		
	15	M7 (4m)	15	15	93,800	9175	IRCM 123 / 160 L 4a		
	17	M7 (4m)	15	17	84,259	8242	IRCM 123 / 160 L 4a		
	19	M7 (4m)	18,5	19	73,179	8829	IRCM 123 / 180 M 4b		
	22	M7 (4m)	22	22	64,396	9239	IRCM 123 / 180 L 4b		
	25	M7 (4m)	22	25	57,140	8198	IRCM 123 / 180 L 4b		
	27	M7 (4m)	30	27	51,045	9986	IRCM 123 / 200 L 4c		
	31	M7 (4m)	30	31	45,853	8971	IRCM 123 / 200 L 4c		
	7,0	M6 (3m)	7,5	7,0	199,476	9756	IRCM 103 / 132 M 4b		
	7,9	M6 (3m)	7,5	7,9	177,284	8671	IRCM 103 / 132 M 4b		
	9,8	M6 (3m)	9,2	10	143,552	8613	IRCM 103 / 132 M 4c		
	12,1	M6 (3m)	11	12	119,126	8545	IRCM 103 / 160 M 4b		
	13,1	M6 (3m)	15	13	109,276	10689	IRCM 103 / 160 L 4a		
	15,1	M6 (3m)	15	15	95,896	9380	IRCM 103 / 160 L 4a		
	18,1	M6 (3m)	18,5	18	78,692	9494	IRCM 103 / 180 M 4b		
	19,1	M6 (3m)	18,5	19	71,869	8671	IRCM 103 / 180 M 4b		
24,1	M6 (3m)	22	24	58,778	8433	IRCM 103 / 180 L 4b			
27,1	M5 (2m)	30	27	51,907	10155	IRCM 103 / 200 L 4c			





D _T Tambur Çapı Drum Diameter <i>Diamètre de l'arbre</i> [mm]	V _h Kaldırma Hızı Lifting Speeds <i>Vitesse de levage</i> [m/min]	Vinç Sınıfı Crane Class <i>Classification de l'application de levage</i> ISO (FEM)	P ₁ Motor Gücü Power <i>Puissance</i> [kW]	n ₂ Çıkış Devri Output Speeds <i>Vitesse de sortie</i> [r.p.m]	i Tahvil Ratio <i>Rapport de réduction</i>	M ₂ Çıkış Momenti Output Torque <i>Couple de sortie</i>	Tip Type <i>Typ</i>		 kg
Ø330	7,3	M6 (3m)	7,5	7,0	199,476	9756	IRCM 103 / 132 M 4b		
	8,2	M6 (3m)	7,5	7,9	177,284	8671	IRCM 103 / 132 M 4b		
	10,2	M6 (3m)	9,2	10	143,552	8613	IRCM 103 / 132 M 4c		
	12,4	M6 (3m)	11	12	119,126	8545	IRCM 103 / 160 M 4b		
	13,5	M6 (3m)	15	13	109,276	10689	IRCM 103 / 160 L 4a		
	15,5	M6 (3m)	15	15	95,896	9380	IRCM 103 / 160 L 4a		
	18,7	M6 (3m)	18,5	18	78,692	9494	IRCM 103 / 180 M 4b		
	19,7	M6 (3m)	18,5	19	71,869	8671	IRCM 103 / 180 M 4b		
	24,9	M5 (2m)	22	24	58,778	8433	IRCM 103 / 180 L 4b		
28,0	M5 (2m)	30	27	51,907	10155	IRCM 103 / 200 L 4c			
Ø340	7,6	M7 (4m)	7,5	7,1	198,333	9700	IRCM 123 / 132 M 4b		
	9,3	M7 (4m)	9,2	8,7	161,000	9659	IRCM 123 / 132 M 4c		
	11	M7 (4m)	9,2	10	134,473	8068	IRCM 123 / 132 M 4c		
	13	M7 (4m)	15	12	118,333	11575	IRCM 123 / 160 L 4a		
	14	M7 (4m)	15	13	105,000	10271	IRCM 123 / 160 L 4a		
	16	M7 (4m)	15	15	93,800	9175	IRCM 123 / 160 L 4a		
	18	M7 (4m)	18,5	17	84,259	10165	IRCM 123 / 180 M 4b		
	20	M7 (4m)	18,5	19	73,179	8829	IRCM 123 / 180 M 4b		
	23	M7 (4m)	22	22	64,396	9239	IRCM 123 / 180 L 4b		
	27	M7 (4m)	30	25	57,140	11179	IRCM 123 / 200 L 4c		
	29	M7 (4m)	30	27	51,045	9986	IRCM 123 / 200 L 4c		
	33	M7 (4m)	30	31	45,853	8971	IRCM 123 / 200 L 4c		
	7,5	M6 (3m)	7,5	7,0	199,476	9756	IRCM 103 / 132 M 4b		
	8,4	M6 (3m)	7,5	7,9	177,284	8671	IRCM 103 / 132 M 4b		
	10,5	M6 (3m)	9,2	10	143,552	8613	IRCM 103 / 132 M 4c		
12,8	M6 (3m)	15	12	119,126	11653	IRCM 103 / 160 L 4a			
13,9	M6 (3m)	15	13	109,276	10689	IRCM 103 / 160 L 4a			
16,0	M6 (3m)	15	15	95,896	9380	IRCM 103 / 160 L 4a			
19,2	M6 (3m)	18,5	18	78,692	9494	IRCM 103 / 180 M 4b			
20,3	M5 (2m)	18,5	19	71,869	8671	IRCM 103 / 180 M 4b			
25,6	M5 (2m)	30	24	58,778	11499	IRCM 103 / 200 L 4c			
28,8	M5 (2m)	30	27	51,907	10155	IRCM 103 / 200 L 4c			
Ø360	8,0	M7 (4m)	7,5	7,1	198,333	9700	IRCM 123 / 132 M 4b		
	9,8	M7 (4m)	9,2	8,7	161,000	9659	IRCM 123 / 132 M 4c		
	11	M7 (4m)	11	10	134,473	9646	IRCM 123 / 160 M 4b		
	14	M7 (4m)	15	12	118,333	11575	IRCM 123 / 160 L 4a		
	15	M7 (4m)	15	13	105,000	10271	IRCM 123 / 160 L 4a		
	17	M7 (4m)	15	15	93,800	9175	IRCM 123 / 160 L 4a		
	19	M7 (4m)	18,5	17	84,259	10165	IRCM 123 / 180 M 4b		
	21	M7 (4m)	18,5	19	73,179	8829	IRCM 123 / 180 M 4b		
	25	M7 (4m)	22	22	64,396	9239	IRCM 123 / 180 L 4b		
	28	M7 (4m)	30	25	57,140	11179	IRCM 123 / 200 L 4c		
	31	M7 (4m)	30	27	51,045	9986	IRCM 123 / 200 L 4c		
	35	M7 (4m)	37	31	45,853	11064	IRCM 123 / 225 S 4a		
	7,9	M5 (2m)	7,5	7,0	199,476	9756	IRCM 103 / 132 M 4b		
	8,9	M5 (2m)	9,2	7,9	177,284	10636	IRCM 103 / 132 M 4c		
	11,1	M5 (2m)	11	10	143,552	10298	IRCM 103 / 160 M 4b		
	13,6	M5 (2m)	15	12	119,126	11653	IRCM 103 / 160 L 4a		
	14,7	M5 (2m)	15	13	109,276	10689	IRCM 103 / 160 L 4a		
	17,0	M5 (2m)	15	15	95,896	9380	IRCM 103 / 160 L 4a		
20,3	M5 (2m)	18,5	18	78,692	9494	IRCM 103 / 180 M 4b			
21,5	M5 (2m)	18,5	19	71,869	8671	IRCM 103 / 180 M 4b			
27,1	M5 (2m)	30	24	58,778	11499	IRCM 103 / 200 L 4c			
30,5	M4 (1Am)	30	27	51,907	10155	IRCM 103 / 200 L 4c			



Vinç sistemleri kaldırma redüktörleri güç ve devir tabloları / Power and ratio table for hoisting applications / Tableau de classification des couples et rapports de réduction pour les applications de levage



D _T Tambur Çapı Drum Diameter <i>Diamètre de l'arbre</i> [mm]	V _h Kaldırma Hızı Lifting Speeds <i>Vitesse de levage</i> [m/min]	Vinç Sınıfı Crane Class <i>Classification de l'application de levage</i> ISO (FEM)	P ₁ Motor Gücü Power <i>Puissance</i> [kW]	n ₂ Çıkış Devri Output Speeds <i>Vitesse de sortie</i> [r.p.m]	i Tahvil Ratio <i>Rapport de réduction</i>	M ₂ Çıkış Momenti Output Torque <i>Couple de sortie</i>	Tip Type <i>Typ</i>		 kg
Ø380	8,5	M7 (4m)	7,5	7,1	198,333	9700	IRCM 123 / 132 M 4b		
	10	M7 (4m)	9,2	8,7	161,000	9659	IRCM 123 / 132 M 4c		
	12	M6 (3m)	11	10	134,473	9646	IRCM 123 / 160 M 4b		
	14	M6 (3m)	15	12	118,333	11575	IRCM 123 / 160 L 4a		
	16	M6 (3m)	15	13	105,000	10271	IRCM 123 / 160 L 4a		
	18	M6 (3m)	18,5	15	93,800	11316	IRCM 123 / 180 M 4b		
	20	M6 (3m)	18,5	17	84,259	10165	IRCM 123 / 180 M 4b		
	23	M6 (3m)	22	19	73,179	10499	IRCM 123 / 180 L 4b		
	26	M6 (3m)	30	22	64,396	12598	IRCM 123 / 200 L 4c		
	30	M6 (3m)	30	25	57,140	11179	IRCM 123 / 200 L 4c		
	32	M6 (3m)	30	27	51,045	9986	IRCM 123 / 200 L 4c		
	37	M6 (3m)	37	31	45,853	11064	IRCM 123 / 225 S 4a		
	8,4	M5 (2m)	7,5	7,0	199,476	9756	IRCM 103 / 132 M 4b		
	9,4	M5 (2m)	9,2	7,9	177,284	10636	IRCM 103 / 132 M 4c		
	11,7	M5 (2m)	11	10	143,552	10298	IRCM 103 / 160 M 4b		
	14,3	M5 (2m)	15	12	119,126	11653	IRCM 103 / 160 L 4a		
	15,5	M5 (2m)	15	13	109,276	10689	IRCM 103 / 160 L 4a		
	17,9	M5 (2m)	18,5	15	95,896	11569	IRCM 103 / 180 M 4b		
	21,5	M5 (2m)	18,5	18	78,692	9494	IRCM 103 / 180 M 4b		
	22,7	M5 (2m)	22	19	71,869	10311	IRCM 103 / 180 L 4b		
28,6	M4 (1Am)	30	24	58,778	11499	IRCM 103 / 200 L 4c			
32,2	M4 (1Am)	30	27	51,907	10155	IRCM 103 / 200 L 4c			
Ø400	8,9	M6 (3m)	9,2	7,1	198,333	11899	IRCM 123 / 132 M 4c		
	11	M6 (3m)	11	8,7	161,000	11549	IRCM 123 / 160 M 4b		
	13	M6 (3m)	11	10	134,473	9646	IRCM 123 / 160 M 4b		
	15	M6 (3m)	15	12	118,333	11575	IRCM 123 / 160 L 4a		
	16	M6 (3m)	15	13	105,000	10271	IRCM 123 / 160 L 4a		
	19	M6 (3m)	18,5	15	93,800	11316	IRCM 123 / 180 M 4b		
	21	M6 (3m)	18,5	17	84,259	10165	IRCM 123 / 180 M 4b		
	24	M6 (3m)	22	19	73,179	10499	IRCM 123 / 180 L 4b		
	28	M6 (3m)	30	22	64,396	12598	IRCM 123 / 200 L 4c		
	31	M6 (3m)	30	25	57,140	11179	IRCM 123 / 200 L 4c		
	34	M6 (3m)	30	27	51,045	9986	IRCM 123 / 200 L 4c		
	39	M6 (3m)	37	31	45,853	11064	IRCM 123 / 225 S 4a		
	8,8	M4 (1Am)	9,2	7,0	199,476	11968	IRCM 103 / 132 M 4c		
	9,9	M4 (1Am)	9,2	7,9	177,284	10636	IRCM 103 / 132 M 4c		
	12,3	M4 (1Am)	11	10	143,552	10298	IRCM 103 / 160 M 4b		
	15,1	M4 (1Am)	15	12	119,126	11653	IRCM 103 / 160 L 4a		
	16,3	M4 (1Am)	15	13	109,276	10689	IRCM 103 / 160 L 4a		
	18,8	M4 (1Am)	18,5	15	95,896	11569	IRCM 103 / 180 M 4b		
	22,6	M4 (1Am)	22	18	78,692	11290	IRCM 103 / 180 L 4b		
	23,9	M4 (1Am)	22	19	71,869	10311	IRCM 103 / 180 L 4b		
30,1	M4 (1Am)	30	24	58,778	11499	IRCM 103 / 200 L 4c			
33,9	M3 (1Bm)	30	27	51,907	10155	IRCM 103 / 200 L 4c			
Ø420	9,4	M6 (3m)	9,2	7,1	198,333	11899	IRCM 123 / 132 M 4c		
	11	M6 (3m)	11	8,7	161,000	11549	IRCM 123 / 160 M 4b		
	13	M6 (3m)	15	10	134,473	13154	IRCM 123 / 160 L 4a		
	16	M6 (3m)	15	12	118,333	11575	IRCM 123 / 160 L 4a		
	17	M6 (3m)	15	13	105,000	10271	IRCM 123 / 160 L 4a		
	20	M6 (3m)	18,5	15	93,800	11316	IRCM 123 / 180 M 4b		
	22	M6 (3m)	22	17	84,259	12088	IRCM 123 / 180 L 4b		
	25	M6 (3m)	22	19	73,179	10499	IRCM 123 / 180 L 4b		
	29	M6 (3m)	30	22	64,396	12598	IRCM 123 / 200 L 4c		
	33	M6 (3m)	30	25	57,140	11179	IRCM 123 / 200 L 4c		
	36	M6 (3m)	37	27	51,045	12317	IRCM 123 / 225 S 4a		
	41	M6 (3m)	37	31	45,853	11064	IRCM 123 / 225 S 4a		





D _T Tambur Çapı Drum Diameter <i>Diamètre de l'arbre</i> [mm]	V _h Kaldırma Hızı Lifting Speeds <i>Vitesse de levage</i> [m/min]	Vinç Sınıfı Crane Class <i>Classification de l'application de levage</i> ISO (FEM)	P ₁ Motor Gücü Power <i>Puissance</i> [kW]	n ₂ Çıkış Devri Output Speeds <i>Vitesse de sortie</i> [r.p.m]	i Tahvil Ratio <i>Rapport de réduction</i>	M ₂ Çıkış Momenti Output Torque <i>Couple de sortie</i>	Tip Type <i>Typ</i>		 kg
	9,2	M4 (1Am)	9,2	7,0	199,476	11968	IRCM 103 / 132 M 4c		
	10,4	M4 (1Am)	9,2	7,9	177,284	10636	IRCM 103 / 132 M 4c		
	12,9	M4 (1Am)	15	10	143,552	14042	IRCM 103 / 160 L 4a		
	15,8	M4 (1Am)	15	12	119,126	11653	IRCM 103 / 160 L 4a		
	17,1	M4 (1Am)	15	13	109,276	10689	IRCM 103 / 160 L 4a		
	19,8	M4 (1Am)	18,5	15	95,896	11569	IRCM 103 / 180 M 4b		
	23,7	M4 (1Am)	22	18	78,692	11290	IRCM 103 / 180 L 4b		
	25,1	M4 (1Am)	22	19	71,869	10311	IRCM 103 / 180 L 4b		
	31,7	M4 (1Am)	30	24	58,778	11499	IRCM 103 / 200 L 4c		
	35,6	M3 (1Bm)	37	27	51,907	12525	IRCM 103 / 225 S 4a		
Ø440	9,8	M6 (3m)	9,2	7,1	198,333	11899	IRCM 123 / 132 M 4c		
	12	M6 (3m)	11	8,7	161,000	11549	IRCM 123 / 160 M 4b		
	14	M6 (3m)	15	10	134,473	13154	IRCM 123 / 160 L 4a		
	17	M6 (3m)	15	12	118,333	11575	IRCM 123 / 160 L 4a		
	18	M6 (3m)	18,5	13	105,000	12668	IRCM 123 / 180 M 4b		
	21	M6 (3m)	18,5	15	93,800	11316	IRCM 123 / 180 M 4b		
	23	M6 (3m)	22	17	84,259	12088	IRCM 123 / 180 L 4b		
	26	M6 (3m)	30	19	73,179	14317	IRCM 123 / 200 L 4c		
	30	M6 (3m)	30	22	64,396	12598	IRCM 123 / 200 L 4c		
	35	M6 (3m)	30	25	57,140	11179	IRCM 123 / 200 L 4c		
	37	M6 (3m)	37	27	51,045	12317	IRCM 123 / 225 S 4a		
	43	M6 (3m)	37	31	45,853	11064	IRCM 123 / 225 S 4a		



Vinç sistemleri kaldırma redüktörleri güç ve devir tabloları / Power and ratio table for hoisting applications / Tableau de classification des couples et rapports de réduction pour les applications de levage

D _T Tambur Çapı Drum Diameter <i>Diamètre de l'arbre</i> [mm]	V _h Kaldırma Hızı Lifting Speeds <i>Vitesse de levage</i> [m/min]	Vinç Sınıfı Crane Class <i>Classification de l'application de levage</i> ISO (FEM)	P ₁ Motor Gücü Power <i>Puissance</i> [kW]	n ₂ Çıkış Devri Output Speeds <i>Vitesse de sortie</i> [r.p.m]	i Tahvil Ratio <i>Rapport de réduction</i>	M ₂ Çıkış Momenti Output Torque <i>Couple de sortie</i>	Tip Type <i>Typ</i>		 kg
Ø270	3,6	M7 (4m)	4	8,6	162,826	4247	IRCM 93 / 112 M 4b		
	4,0	M7 (4m)	4	9,5	146,946	3833	IRCM 93 / 112 M 4b		
	4,2	M6 (3m)	4	10	133,419	3480	IRCM 93 / 112 M 4b		
	5,5	M6 (3m)	5,5	13	111,602	4003	IRCM 93 / 132 S 4c		
	6,8	M6 (3m)	7,5	16	87,936	4301	IRCM 93 / 132 M 4b		
	7,6	M6 (3m)	7,5	18	79,841	3905	IRCM 93 / 132 M 4b		
	8,9	M6 (3m)	9,2	21	66,785	4007	IRCM 93 / 132 M 4c		
	9,7	M6 (3m)	9,2	23	61,444	3686	IRCM 93 / 132 M 4c		
	11	M5 (2m)	11	26	54,545	3913	IRCM 93 / 160 M 4b		
	13	M5 (2m)	15	31	44,753	4378	IRCM 93 / 160 L 4a		
	16	M5 (2m)	15	38	37,199	3639	IRCM 93 / 160 L 4a		
	17	M5 (2m)	15	41	34,034	3329	IRCM 93 / 160 L 4a		
Ø280	19	M5 (2m)	18,5	45	31,194	3763	IRCM 93 / 180 M 4b		
	3,8	M6 (3m)	4	8,6	162,826	4247	IRCM 93 / 112 M 4b		
	4,2	M6 (3m)	4	9,5	146,946	3833	IRCM 93 / 112 M 4b		
	4,4	M6 (3m)	4	10	133,419	3480	IRCM 93 / 112 M 4b		
	5,7	M6 (3m)	5,5	13	111,602	4003	IRCM 93 / 132 S 4c		
	7,0	M6 (3m)	7,5	16	87,936	4301	IRCM 93 / 132 M 4b		
	7,9	M6 (3m)	7,5	18	79,841	3905	IRCM 93 / 132 M 4b		
	9,2	M6 (3m)	9,2	21	66,785	4007	IRCM 93 / 132 M 4c		
	10	M6 (3m)	9,2	23	61,444	3686	IRCM 93 / 132 M 4c		
	11	M5 (2m)	11	26	54,545	3913	IRCM 93 / 160 M 4b		
	14	M5 (2m)	15	31	44,753	4378	IRCM 93 / 160 L 4a		
	17	M5 (2m)	15	38	37,199	3639	IRCM 93 / 160 L 4a		
Ø290	18	M5 (2m)	18,5	41	34,034	4106	IRCM 93 / 180 M 4b		
	20	M5 (2m)	18,5	45	31,194	3763	IRCM 93 / 180 M 4b		
	3,9	M6 (3m)	4	8,6	162,826	4247	IRCM 93 / 112 M 4b		
	4,3	M6 (3m)	4	9,5	146,946	3833	IRCM 93 / 112 M 4b		
	4,6	M6 (3m)	4	10	133,419	3480	IRCM 93 / 112 M 4b		
	5,9	M6 (3m)	5,5	13	111,602	4003	IRCM 93 / 132 S 4c		
	7,3	M6 (3m)	7,5	16	87,936	4301	IRCM 93 / 132 M 4b		
	8,2	M6 (3m)	7,5	18	79,841	3905	IRCM 93 / 132 M 4b		
	9,6	M5 (2m)	9,2	21	66,785	4007	IRCM 93 / 132 M 4c		
	10	M5 (2m)	9,2	23	61,444	3686	IRCM 93 / 132 M 4c		
	12	M5 (2m)	11	26	54,545	3913	IRCM 93 / 160 M 4b		
	14	M4 (1Am)	15	31	44,753	4378	IRCM 93 / 160 L 4a		
Ø300	17	M4 (1Am)	15	38	37,199	3639	IRCM 93 / 160 L 4a		
	19	M4 (1Am)	18,5	41	34,034	4106	IRCM 93 / 180 M 4b		
	20	M4 (1Am)	18,5	45	31,194	3763	IRCM 93 / 180 M 4b		
	4,1	M6 (3m)	4	8,6	162,826	4247	IRCM 93 / 112 M 4b		
	4,5	M6 (3m)	4	9,5	146,946	3833	IRCM 93 / 112 M 4b		
	4,7	M6 (3m)	5,5	10	133,419	4785	IRCM 93 / 132 S 4c		
	6,1	M6 (3m)	5,5	13	111,602	4003	IRCM 93 / 132 S 4c		
	7,5	M6 (3m)	7,5	16	87,936	4301	IRCM 93 / 132 M 4b		
	8,5	M5 (2m)	7,5	18	79,841	3905	IRCM 93 / 132 M 4b		
	9,9	M5 (2m)	9,2	21	66,785	4007	IRCM 93 / 132 M 4c		
	11	M5 (2m)	11	23	61,444	4408	IRCM 93 / 160 M 4b		
	12	M5 (2m)	11	26	54,545	3913	IRCM 93 / 160 M 4b		
15	M4 (1Am)	15	31	44,753	4378	IRCM 93 / 160 L 4a			
18	M4 (1Am)	18,5	38	37,199	4488	IRCM 93 / 180 M 4b			
19	M4 (1Am)	18,5	41	34,034	4106	IRCM 93 / 180 M 4b			
21	M4 (1Am)	18,5	45	31,194	3763	IRCM 93 / 180 M 4b			





D _T Tambur Çapı Drum Diameter <i>Diamètre de l'arbre</i> [mm]	V _h Kaldırma Hızı Lifting Speeds <i>Vitesse de levage</i> [m/min]	Vinç Sınıfı Crane Class <i>Classification de l'application de levage</i> ISO (FEM)	P ₁ Motor Gücü Power <i>Puissance</i> [kW]	n ₂ Çıkış Devri Output Speeds <i>Vitesse de sortie</i> [r.p.m]	i Tahvil Ratio <i>Rapport de réduction</i>	M ₂ Çıkış Momenti Output Torque <i>Couple de sortie</i>	Tip Type <i>Typ</i>		 kg
Ø310	4,2	M6 (3m)	4	8,6	162,826	4247	IRCM 93 / 112 M 4b		
	4,6	M6 (3m)	4	9,5	146,946	3833	IRCM 93 / 112 M 4b		
	4,9	M6 (3m)	5,5	10	133,419	4785	IRCM 93 / 132 S 4c		
	6,3	M6 (3m)	5,5	13	111,602	4003	IRCM 93 / 132 S 4c		
	7,8	M5 (2m)	7,5	16	87,936	4301	IRCM 93 / 132 M 4b		
	8,8	M5 (2m)	9,2	18	79,841	4790	IRCM 93 / 132 M 4c		
	10	M5 (2m)	9,2	21	66,785	4007	IRCM 93 / 132 M 4c		
	11	M5 (2m)	11	23	61,444	4408	IRCM 93 / 160 M 4b		
	13	M4 (1Am)	11	26	54,545	3913	IRCM 93 / 160 M 4b		
	15	M4 (1Am)	15	31	44,753	4378	IRCM 93 / 160 L 4a		
	18	M4 (1Am)	18,5	38	37,199	4488	IRCM 93 / 180 M 4b		
	20	M4 (1Am)	18,5	41	34,034	4106	IRCM 93 / 180 M 4b		
Ø320	22	M4 (1Am)	22	45	31,194	4475	IRCM 93 / 180 L 4b		
	4,3	M6 (3m)	4	8,6	162,826	4247	IRCM 93 / 112 M 4b		
	4,8	M6 (3m)	5,5	9,5	146,946	5271	IRCM 93 / 132 S 4c		
	5,0	M6 (3m)	5,5	10	133,419	4785	IRCM 93 / 132 S 4c		
	6,5	M5 (2m)	7,5	13	111,602	5458	IRCM 93 / 132 M 4b		
	8,0	M5 (2m)	7,5	16	87,936	4301	IRCM 93 / 132 M 4b		
	9,0	M5 (2m)	9,2	18	79,841	4790	IRCM 93 / 132 M 4c		
	11	M4 (1Am)	9,2	21	66,785	4007	IRCM 93 / 132 M 4c		
	12	M4 (1Am)	11	23	61,444	4408	IRCM 93 / 160 M 4b		
	13	M4 (1Am)	15	26	54,545	5336	IRCM 93 / 160 L 4a		
Ø330	16	M4 (1Am)	15	31	44,753	4378	IRCM 93 / 160 L 4a		
	19	M4 (1Am)	18,5	38	37,199	4488	IRCM 93 / 180 M 4b		
	4,5	M6 (3m)	4	8,6	162,826	4247	IRCM 93 / 112 M 4b		
	4,9	M6 (3m)	5,5	9,5	146,946	5271	IRCM 93 / 132 S 4c		
	5,2	M5 (2m)	5,5	10	133,419	4785	IRCM 93 / 132 S 4c		
	6,7	M5 (2m)	7,5	13	111,602	5458	IRCM 93 / 132 M 4b		
	8,3	M5 (2m)	7,5	16	87,936	4301	IRCM 93 / 132 M 4b		
	9,3	M5 (2m)	9,2	18	79,841	4790	IRCM 93 / 132 M 4c		
	11	M4 (1Am)	11	21	66,785	4791	IRCM 93 / 160 M 4b		
	12	M4 (1Am)	11	23	61,444	4408	IRCM 93 / 160 M 4b		
Ø340	13	M4 (1Am)	15	26	54,545	5336	IRCM 93 / 160 L 4a		
	16	M4 (1Am)	15	31	44,753	4378	IRCM 93 / 160 L 4a		
	20	M4 (1Am)	18,5	38	37,199	4488	IRCM 93 / 180 M 4b		
	4,6	M5 (2m)	4	8,6	162,826	4247	IRCM 93 / 112 M 4b		
	5,1	M5 (2m)	5,5	9,5	146,946	5271	IRCM 93 / 132 S 4c		
	5,3	M5 (2m)	5,5	10	133,419	4785	IRCM 93 / 132 S 4c		
	6,9	M5 (2m)	7,5	13	111,602	5458	IRCM 93 / 132 M 4b		
	8,5	M5 (2m)	7,5	16	87,936	4301	IRCM 93 / 132 M 4b		
	9,6	M4 (1Am)	9,2	18	79,841	4790	IRCM 93 / 132 M 4c		
	11	M4 (1Am)	11	21	66,785	4791	IRCM 93 / 160 M 4b		
Ø340	12	M4 (1Am)	11	23	61,444	4408	IRCM 93 / 160 M 4b		
	14	M4 (1Am)	15	26	54,545	5336	IRCM 93 / 160 L 4a		
	17	M4 (1Am)	15	31	44,753	4378	IRCM 93 / 160 L 4a		



Vinç sistemleri kaldırma redüktörleri güç ve devir tabloları / Power and ratio table for hoisting applications / Tableau de classification des couples et rapports de réduction pour les applications de levage



Vinç sistemleri kaldırma redüktörleri güç ve devir tabloları / Power and ratio table for hoisting applications / Tableau de classification des couples et rapports de réduction pour les applications de levage

D _T Tambur Çapı Drum Diameter Diamètre de l'arbre [mm]	V _h Kaldırma Hızı Lifting Speeds Vitesse de levage [m/min]	Vinç Sınıfı Crane Class Classification de l'application de levage ISO (FEM)	P ₁ Motor Gücü Power Puissance [kW]	n ₂ Çıkış Devri Output Speeds Vitesse de sortie [r.p.m]	i Tahvil Ratio Rapport de réduction	M ₂ Çıkış Momenti Output Torque Couple de sortie	Tip Type Typ		 kg
Ø170	1,1	M8 (5m)	1,1	8,6	162,826	1168	IRCM 93 / 90 S 4a		
	1,3	M8 (5m)	1,1	9,5	146,946	1054	IRCM 93 / 90 S 4a		
	1,3	M8 (5m)	1,5	10	133,419	1305	IRCM 93 / 90 L 4a		
	1,7	M8 (5m)	1,5	13	111,602	1092	IRCM 93 / 90 L 4a		
	2,1	M8 (5m)	2,2	16	87,936	1262	IRCM 93 / 100 L 4a		
	2,4	M8 (5m)	2,2	18	79,841	1145	IRCM 93 / 100 L 4a		
	2,8	M8 (5m)	3	21	66,785	1307	IRCM 93 / 100 L 4b		
	3,1	M8 (5m)	3	23	61,444	1202	IRCM 93 / 100 L 4b		
	3,5	M8 (5m)	3	26	54,545	1067	IRCM 93 / 100 L 4b		
	4,1	M8 (5m)	4	31	44,753	1167	IRCM 93 / 112 M 4b		
	5,1	M8 (5m)	5,5	38	37,199	1334	IRCM 93 / 132 S 4c		
	5,5	M8 (5m)	5,5	41	34,034	1221	IRCM 93 / 132 S 4c		
	6,0	M8 (5m)	5,5	45	31,194	1119	IRCM 93 / 132 S 4c		
	1,3	M8 (5m)	1,5	10	133,509	1306	IRCM 83 / 90 L 4a		
	1,6	M8 (5m)	1,5	12	121,711	1191	IRCM 83 / 90 L 4a		
	1,9	M8 (5m)	2,2	14	102,407	1469	IRCM 83 / 100 L 4a		
	2,0	M8 (5m)	2,2	15	92,330	1325	IRCM 83 / 100 L 4a		
	2,5	M7 (4m)	2,2	19	75,613	1085	IRCM 83 / 100 L 4a		
	3,1	M7 (4m)	3	23	60,299	1180	IRCM 83 / 100 L 4b		
	3,5	M7 (4m)	3	26	54,358	1063	IRCM 83 / 100 L 4b		
3,9	M7 (4m)	4	29	48,314	1260	IRCM 83 / 112 M 4b			
4,7	M7 (4m)	5,5	35	39,796	1427	IRCM 83 / 132 S 4c			
5,6	M7 (4m)	5,5	42	33,003	1184	IRCM 83 / 132 S 4c			
6,8	M7 (4m)	7,5	51	27,535	1347	IRCM 83 / 132 M 4b			
Ø180	1,2	M8 (5m)	1,1	8,6	162,826	1168	IRCM 93 / 90 S 4a		
	1,3	M8 (5m)	1,5	9,5	146,946	1437	IRCM 93 / 90 L 4a		
	1,4	M8 (5m)	1,5	10	133,419	1305	IRCM 93 / 90 L 4a		
	1,8	M8 (5m)	2,2	13	111,602	1601	IRCM 93 / 100 L 4a		
	2,3	M8 (5m)	2,2	16	87,936	1262	IRCM 93 / 100 L 4a		
	2,5	M8 (5m)	2,2	18	79,841	1145	IRCM 93 / 100 L 4a		
	3,0	M8 (5m)	3	21	66,785	1307	IRCM 93 / 100 L 4b		
	3,2	M8 (5m)	3	23	61,444	1202	IRCM 93 / 100 L 4b		
	3,7	M8 (5m)	4	26	54,545	1423	IRCM 93 / 112 M 4b		
	4,4	M8 (5m)	4	31	44,753	1167	IRCM 93 / 112 M 4b		
	5,4	M8 (5m)	5,5	38	37,199	1334	IRCM 93 / 132 S 4c		
	5,8	M8 (5m)	5,5	41	34,034	1221	IRCM 93 / 132 S 4c		
	6,4	M8 (5m)	5,5	45	31,194	1119	IRCM 93 / 132 S 4c		
	1,4	M7 (4m)	1,5	10	133,509	1306	IRCM 83 / 90 L 4a		
	1,7	M7 (4m)	1,5	12	121,711	1191	IRCM 83 / 90 L 4a		
	2,0	M7 (4m)	2,2	14	102,407	1469	IRCM 83 / 100 L 4a		
	2,1	M7 (4m)	2,2	15	92,330	1325	IRCM 83 / 100 L 4a		
	2,7	M7 (4m)	3	19	75,613	1479	IRCM 83 / 100 L 4b		
	3,2	M7 (4m)	3	23	60,299	1180	IRCM 83 / 100 L 4b		
	3,7	M7 (4m)	4	26	54,358	1418	IRCM 83 / 112 M 4b		
4,1	M7 (4m)	4	29	48,314	1260	IRCM 83 / 112 M 4b			
4,9	M7 (4m)	5,5	35	39,796	1427	IRCM 83 / 132 S 4c			
5,9	M7 (4m)	5,5	42	33,003	1184	IRCM 83 / 132 S 4c			
7,2	M7 (4m)	7,5	51	27,535	1347	IRCM 83 / 132 M 4b			





D _T Tambur Çapı Drum Diameter <i>Diamètre de l'arbre</i> [mm]	V _h Kaldırma Hızı Lifting Speeds <i>Vitesse de levage</i> [m/min]	Vinç Sınıfı Crane Class <i>Classification de l'application de levage</i> ISO (FEM)	P ₁ Motor Gücü Power <i>Puissance</i> [kW]	n ₂ Çıkış Devri Output Speeds <i>Vitesse de sortie</i> [r.p.m]	i Tahvil Ratio <i>Rapport de réduction</i>	M ₂ Çıkış Momenti Output Torque <i>Couple de sortie</i>	Tip Type <i>Typ</i>		 kg
Ø190	1,3	M8 (5m)	1,5	8,6	162,826	1593	IRCM 93 / 90 L 4a		
	1,4	M8 (5m)	1,5	9,5	146,946	1437	IRCM 93 / 90 L 4a		
	1,5	M8 (5m)	1,5	10	133,419	1305	IRCM 93 / 90 L 4a		
	1,9	M8 (5m)	2,2	13	111,602	1601	IRCM 93 / 100 L 4a		
	2,4	M8 (5m)	2,2	16	87,936	1262	IRCM 93 / 100 L 4a		
	2,7	M8 (5m)	3	18	79,841	1562	IRCM 93 / 100 L 4b		
	3,1	M8 (5m)	3	21	66,785	1307	IRCM 93 / 100 L 4b		
	3,4	M8 (5m)	3	23	61,444	1202	IRCM 93 / 100 L 4b		
	3,9	M8 (5m)	4	26	54,545	1423	IRCM 93 / 112 M 4b		
	4,6	M8 (5m)	4	31	44,753	1167	IRCM 93 / 112 M 4b		
	5,7	M8 (5m)	5,5	38	37,199	1334	IRCM 93 / 132 S 4c		
	6,1	M8 (5m)	5,5	41	34,034	1221	IRCM 93 / 132 S 4c		
	6,7	M8 (5m)	7,5	45	31,194	1526	IRCM 93 / 132 M 4b		
	1,5	M7 (4m)	1,5	10	133,509	1306	IRCM 83 / 90 L 4a		
	1,8	M7 (4m)	2,2	12	121,711	1746	IRCM 83 / 100 L 4a		
	2,1	M7 (4m)	2,2	14	102,407	1469	IRCM 83 / 100 L 4a		
	2,2	M7 (4m)	2,2	15	92,330	1325	IRCM 83 / 100 L 4a		
	2,8	M7 (4m)	3	19	75,613	1479	IRCM 83 / 100 L 4b		
	3,4	M7 (4m)	3	23	60,299	1180	IRCM 83 / 100 L 4b		
	3,9	M7 (4m)	4	26	54,358	1418	IRCM 83 / 112 M 4b		
	4,3	M7 (4m)	4	29	48,314	1260	IRCM 83 / 112 M 4b		
	5,2	M7 (4m)	5,5	35	39,796	1427	IRCM 83 / 132 S 4c		
6,3	M7 (4m)	5,5	42	33,003	1184	IRCM 83 / 132 S 4c			
7,6	M6 (3m)	7,5	51	27,535	1347	IRCM 83 / 132 M 4b			
Ø200	1,4	M8 (5m)	1,5	8,6	162,826	1593	IRCM 93 / 90 L 4a		
	1,5	M8 (5m)	1,5	9,5	146,946	1437	IRCM 93 / 90 L 4a		
	1,6	M8 (5m)	1,5	10	133,419	1305	IRCM 93 / 90 L 4a		
	2,0	M8 (5m)	2,2	13	111,602	1601	IRCM 93 / 100 L 4a		
	2,5	M8 (5m)	2,2	16	87,936	1262	IRCM 93 / 100 L 4a		
	2,8	M8 (5m)	3	18	79,841	1562	IRCM 93 / 100 L 4b		
	3,3	M8 (5m)	3	21	66,785	1307	IRCM 93 / 100 L 4b		
	3,6	M8 (5m)	4	23	61,444	1603	IRCM 93 / 112 M 4b		
	4,1	M8 (5m)	4	26	54,545	1423	IRCM 93 / 112 M 4b		
	4,9	M8 (5m)	5,5	31	44,753	1605	IRCM 93 / 132 S 4c		
	6,0	M8 (5m)	5,5	38	37,199	1334	IRCM 93 / 132 S 4c		
	6,4	M8 (5m)	7,5	41	34,034	1665	IRCM 93 / 132 M 4b		
	7,1	M8 (5m)	7,5	45	31,194	1526	IRCM 93 / 132 M 4b		
	1,6	M7 (4m)	1,5	10	133,509	1306	IRCM 83 / 90 L 4a		
	1,9	M7 (4m)	2,2	12	121,711	1746	IRCM 83 / 100 L 4a		
	2,2	M7 (4m)	2,2	14	102,407	1469	IRCM 83 / 100 L 4a		
	2,4	M7 (4m)	2,2	15	92,330	1325	IRCM 83 / 100 L 4a		
	3,0	M7 (4m)	3	19	75,613	1479	IRCM 83 / 100 L 4b		
	3,6	M7 (4m)	4	23	60,299	1573	IRCM 83 / 112 M 4b		
	4,1	M7 (4m)	4	26	54,358	1418	IRCM 83 / 112 M 4b		
	4,6	M7 (4m)	4	29	48,314	1260	IRCM 83 / 112 M 4b		
	5,5	M6 (3m)	5,5	35	39,796	1427	IRCM 83 / 132 S 4c		
6,6	M6 (3m)	7,5	42	33,003	1614	IRCM 83 / 132 M 4b			
8,0	M6 (3m)	7,5	51	27,535	1347	IRCM 83 / 132 M 4b			



Vinç sistemleri kaldırma redüktörleri güç ve devir tabloları / Power and ratio table for hoisting applications / Tableau de classification des couples et rapports de réduction pour les applications de levage



Vinç sistemleri kaldırma redüktörleri güç ve devir tabloları / Power and ratio table for hoisting applications / Tableau de classification des couples et rapports de réduction pour les applications de levage



D _T Tambur Çapı Drum Diameter <i>Diamètre de l'arbre</i> [mm]	V _h Kaldırma Hızı Lifting Speeds <i>Vitesse de levage</i> [m/min]	Vinç Sınıfı Crane Class <i>Classification de l'application de levage</i> ISO (FEM)	P ₁ Motor Gücü Power <i>Puissance</i> [kW]	n ₂ Çıkış Devri Output Speeds <i>Vitesse de sortie</i> [r.p.m]	i Tahvil Ratio <i>Rapport de réduction</i>	M ₂ Çıkış Momenti Output Torque <i>Couple de sortie</i>	Tip Type <i>Typ</i>		 kg
Ø210	1,4	M8 (5m)	1,5	8,6	162,826	1593	IRCM 93 / 90 L 4a		
	1,6	M8 (5m)	1,5	9,5	146,946	1437	IRCM 93 / 90 L 4a		
	1,6	M8 (5m)	1,5	10	133,419	1305	IRCM 93 / 90 L 4a		
	2,1	M8 (5m)	2,2	13	111,602	1601	IRCM 93 / 100 L 4a		
	2,6	M8 (5m)	3	16	87,936	1720	IRCM 93 / 100 L 4b		
	3,0	M8 (5m)	3	18	79,841	1562	IRCM 93 / 100 L 4b		
	3,5	M8 (5m)	3	21	66,785	1307	IRCM 93 / 100 L 4b		
	3,8	M8 (5m)	4	23	61,444	1603	IRCM 93 / 112 M 4b		
	4,3	M8 (5m)	4	26	54,545	1423	IRCM 93 / 112 M 4b		
	5,1	M8 (5m)	5,5	31	44,753	1605	IRCM 93 / 132 S 4c		
	6,3	M8 (5m)	5,5	38	37,199	1334	IRCM 93 / 132 S 4c		
	6,8	M8 (5m)	7,5	41	34,034	1665	IRCM 93 / 132 M 4b		
	7,4	M8 (5m)	7,5	45	31,194	1526	IRCM 93 / 132 M 4b		
	1,6	M7 (4m)	1,5	10	133,509	1306	IRCM 83 / 90 L 4a		
	2,0	M7 (4m)	2,2	12	121,711	1746	IRCM 83 / 100 L 4a		
	2,3	M7 (4m)	2,2	14	102,407	1469	IRCM 83 / 100 L 4a		
	2,5	M7 (4m)	2,2	15	92,330	1325	IRCM 83 / 100 L 4a		
	3,1	M7 (4m)	3	19	75,613	1479	IRCM 83 / 100 L 4b		
	3,8	M7 (4m)	4	23	60,299	1573	IRCM 83 / 112 M 4b		
	4,3	M7 (4m)	4	26	54,358	1418	IRCM 83 / 112 M 4b		
4,8	M6 (3m)	5,5	29	48,314	1733	IRCM 83 / 132 S 4c			
5,8	M6 (3m)	5,5	35	39,796	1427	IRCM 83 / 132 S 4c			
6,9	M6 (3m)	7,5	42	33,003	1614	IRCM 83 / 132 M 4b			
8,4	M6 (3m)	7,5	51	27,535	1347	IRCM 83 / 132 M 4b			
Ø220	1,5	M8 (5m)	1,5	8,6	162,826	1593	IRCM 93 / 90 L 4a		
	1,6	M8 (5m)	1,5	9,5	146,946	1437	IRCM 93 / 90 L 4a		
	1,7	M8 (5m)	1,5	10	133,419	1305	IRCM 93 / 90 L 4a		
	2,2	M8 (5m)	2,2	13	111,602	1601	IRCM 93 / 100 L 4a		
	2,8	M8 (5m)	3	16	87,936	1720	IRCM 93 / 100 L 4b		
	3,1	M8 (5m)	3	18	79,841	1562	IRCM 93 / 100 L 4b		
	3,6	M8 (5m)	4	21	66,785	1742	IRCM 93 / 112 M 4b		
	4,0	M8 (5m)	4	23	61,444	1603	IRCM 93 / 112 M 4b		
	4,5	M8 (5m)	4	26	54,545	1423	IRCM 93 / 112 M 4b		
	5,4	M8 (5m)	5,5	31	44,753	1605	IRCM 93 / 132 S 4c		
	6,6	M8 (5m)	7,5	38	37,199	1819	IRCM 93 / 132 M 4b		
	7,1	M8 (5m)	7,5	41	34,034	1665	IRCM 93 / 132 M 4b		
	7,8	M8 (5m)	7,5	45	31,194	1526	IRCM 93 / 132 M 4b		
	1,7	M7 (4m)	1,5	10	133,509	1306	IRCM 83 / 90 L 4a		
	2,1	M7 (4m)	2,2	12	121,711	1746	IRCM 83 / 100 L 4a		
	2,4	M6 (3m)	2,2	14	102,407	1469	IRCM 83 / 100 L 4a		
	2,6	M6 (3m)	3	15	92,330	1806	IRCM 83 / 100 L 4b		
	3,3	M6 (3m)	3	19	75,613	1479	IRCM 83 / 100 L 4b		
	4,0	M6 (3m)	4	23	60,299	1573	IRCM 83 / 112 M 4b		
	4,5	M6 (3m)	4	26	54,358	1418	IRCM 83 / 112 M 4b		
5,0	M6 (3m)	5,5	29	48,314	1733	IRCM 83 / 132 S 4c			
6,0	M6 (3m)	5,5	35	39,796	1427	IRCM 83 / 132 S 4c			
7,3	M6 (3m)	7,5	42	33,003	1614	IRCM 83 / 132 M 4b			
8,8	M6 (3m)	9,2	51	27,535	1652	IRCM 83 / 132 M 4c			





D _T Tambur Çapı Drum Diameter <i>Diamètre de l'arbre</i> [mm]	V _h Kaldırma Hızı Lifting Speeds <i>Vitesse de levage</i> [m/min]	Vinç Sınıfı Crane Class <i>Classification de l'application de levage</i> ISO (FEM)	P ₁ Motor Gücü Power <i>Puissance</i> [kW]	n ₂ Çıkış Devri Output Speeds <i>Vitesse de sortie</i> [r.p.m]	i Tahvil Ratio <i>Rapport de réduction</i>	M ₂ Çıkış Momenti Output Torque <i>Couple de sortie</i>	Tip Type <i>Typ</i>		 kg
Ø230	1,6	M8 (5m)	1,5	8,6	162,826	1593	IRCM 93 / 90 L 4a		
	1,7	M8 (5m)	1,5	9,5	146,946	1437	IRCM 93 / 90 L 4a		
	1,8	M8 (5m)	2,2	10	133,419	1914	IRCM 93 / 100 L 4a		
	2,3	M8 (5m)	2,2	13	111,602	1601	IRCM 93 / 100 L 4a		
	2,9	M8 (5m)	3	16	87,936	1720	IRCM 93 / 100 L 4b		
	3,2	M8 (5m)	3	18	79,841	1562	IRCM 93 / 100 L 4b		
	3,8	M8 (5m)	4	21	66,785	1742	IRCM 93 / 112 M 4b		
	4,2	M8 (5m)	4	23	61,444	1603	IRCM 93 / 112 M 4b		
	4,7	M8 (5m)	5,5	26	54,545	1956	IRCM 93 / 132 S 4c		
	5,6	M8 (5m)	5,5	31	44,753	1605	IRCM 93 / 132 S 4c		
	6,9	M8 (5m)	7,5	38	37,199	1819	IRCM 93 / 132 M 4b		
	7,4	M8 (5m)	7,5	41	34,034	1665	IRCM 93 / 132 M 4b		
	8,1	M8 (5m)	7,5	45	31,194	1526	IRCM 93 / 132 M 4b		
	1,8	M6 (3m)	2,2	10	133,509	1915	IRCM 83 / 100 L 4a		
	2,2	M6 (3m)	2,2	12	121,711	1746	IRCM 83 / 100 L 4a		
	2,5	M6 (3m)	2,2	14	102,407	1469	IRCM 83 / 100 L 4a		
	2,7	M6 (3m)	3	15	92,330	1806	IRCM 83 / 100 L 4b		
	3,4	M6 (3m)	3	19	75,613	1479	IRCM 83 / 100 L 4b		
	4,2	M6 (3m)	4	23	60,299	1573	IRCM 83 / 112 M 4b		
	4,7	M6 (3m)	5,5	26	54,358	1950	IRCM 83 / 132 S 4c		
	5,2	M6 (3m)	5,5	29	48,314	1733	IRCM 83 / 132 S 4c		
	6,3	M6 (3m)	5,5	35	39,796	1427	IRCM 83 / 132 S 4c		
7,6	M6 (3m)	7,5	42	33,003	1614	IRCM 83 / 132 M 4b			
9,2	M5 (2m)	9,2	51	27,535	1652	IRCM 83 / 132 M 4c			
Ø240	1,6	M8 (5m)	1,5	8,6	162,826	1593	IRCM 93 / 90 L 4a		
	1,8	M8 (5m)	2,2	9,5	146,946	2108	IRCM 93 / 100 L 4a		
	1,9	M8 (5m)	2,2	10	133,419	1914	IRCM 93 / 100 L 4a		
	2,4	M8 (5m)	2,2	13	111,602	1601	IRCM 93 / 100 L 4a		
	3,0	M8 (5m)	3	16	87,936	1720	IRCM 93 / 100 L 4b		
	3,4	M8 (5m)	3	18	79,841	1562	IRCM 93 / 100 L 4b		
	4,0	M8 (5m)	4	21	66,785	1742	IRCM 93 / 112 M 4b		
	4,3	M8 (5m)	4	23	61,444	1603	IRCM 93 / 112 M 4b		
	4,9	M8 (5m)	5,5	26	54,545	1956	IRCM 93 / 132 S 4c		
	5,8	M8 (5m)	5,5	31	44,753	1605	IRCM 93 / 132 S 4c		
	7,2	M8 (5m)	7,5	38	37,199	1819	IRCM 93 / 132 M 4b		
	7,7	M8 (5m)	7,5	41	34,034	1665	IRCM 93 / 132 M 4b		
	8,5	M8 (5m)	7,5	45	31,194	1526	IRCM 93 / 132 M 4b		
	1,9	M6 (3m)	2,2	10	133,509	1915	IRCM 83 / 100 L 4a		
	2,3	M6 (3m)	2,2	12	121,711	1746	IRCM 83 / 100 L 4a		
	2,6	M6 (3m)	3	14	102,407	2003	IRCM 83 / 100 L 4b		
	2,8	M6 (3m)	3	15	92,330	1806	IRCM 83 / 100 L 4b		
	3,6	M6 (3m)	4	19	75,613	1972	IRCM 83 / 112 M 4b		
	4,3	M6 (3m)	4	23	60,299	1573	IRCM 83 / 112 M 4b		
	4,9	M6 (3m)	5,5	26	54,358	1950	IRCM 83 / 132 S 4c		
	5,5	M6 (3m)	5,5	29	48,314	1733	IRCM 83 / 132 S 4c		
	6,6	M6 (3m)	7,5	35	39,796	1946	IRCM 83 / 132 M 4b		
7,9	M5 (2m)	7,5	42	33,003	1614	IRCM 83 / 132 M 4b			
9,6	M5 (2m)	9,2	51	27,535	1652	IRCM 83 / 132 M 4c			



Vinç sistemleri kaldırma redüktörleri güç ve devir tabloları / Power and ratio table for hoisting applications / Tableau de classification des couples et rapports de réduction pour les applications de levage

D _T Tambur Çapı Drum Diameter Diamètre de l'arbre [mm]	V _h Kaldırma Hızı Lifting Speeds Vitesse de levage [m/min]	Vinç Sınıfı Crane Class Classification de l'application de levage ISO (FEM)	P ₁ Motor Gücü Power Puissance [kW]	n ₂ Çıkış Devri Output Speeds Vitesse de sortie [r.p.m]	i Tahvil Ratio Rapport de réduction	M ₂ Çıkış Momenti Output Torque Couple de sortie	Tip Type Typ		 kg
Ø110	0,7	M8 (5m)	0,75	12	120,792	591	IRCM 73 / 80 M 4b		
	0,7	M8 (5m)	0,75	13	107,423	525	IRCM 73 / 80 M 4b		
	0,9	M8 (5m)	0,75	15	96,194	470	IRCM 73 / 80 M 4b		
	0,9	M8 (5m)	1,1	16	86,628	621	IRCM 73 / 90 S 4a		
	1,1	M8 (5m)	1,1	19	73,889	530	IRCM 73 / 90 S 4a		
	1,2	M8 (5m)	1,1	21	65,252	468	IRCM 73 / 90 S 4a		
	1,4	M8 (5m)	1,5	24	57,996	567	IRCM 73 / 90 L 4a		
	1,6	M8 (5m)	1,5	27	51,846	507	IRCM 73 / 90 L 4a		
	1,9	M8 (5m)	2,2	33	41,848	600	IRCM 73 / 100 L 4a		
	2,2	M8 (5m)	2,2	39	35,564	510	IRCM 73 / 100 L 4a		
	2,5	M8 (5m)	2,2	44	32,098	461	IRCM 73 / 100 L 4a		
	3,1	M8 (5m)	3	53	26,291	514	IRCM 73 / 100 L 4b		
3,4	M8 (5m)	3	59	23,834	466	IRCM 73 / 100 L 4b			
Ø120	0,8	M8 (5m)	0,75	12	120,792	591	IRCM 73 / 80 M 4b		
	0,8	M8 (5m)	0,75	13	107,423	525	IRCM 73 / 80 M 4b		
	0,9	M8 (5m)	1,1	15	96,194	690	IRCM 73 / 90 S 4a		
	1,0	M8 (5m)	1,1	16	86,628	621	IRCM 73 / 90 S 4a		
	1,2	M8 (5m)	1,1	19	73,889	530	IRCM 73 / 90 S 4a		
	1,3	M8 (5m)	1,5	21	65,252	638	IRCM 73 / 90 L 4a		
	1,5	M8 (5m)	1,5	24	57,996	567	IRCM 73 / 90 L 4a		
	1,7	M8 (5m)	1,5	27	51,816	507	IRCM 73 / 90 L 4a		
	2,1	M8 (5m)	2,2	33	41,848	600	IRCM 73 / 100 L 4a		
	2,4	M8 (5m)	2,2	39	35,564	510	IRCM 73 / 100 L 4a		
	2,8	M8 (5m)	3	44	32,098	628	IRCM 73 / 100 L 4b		
	3,3	M7 (4m)	3	53	26,291	514	IRCM 73 / 100 L 4b		
3,7	M7 (4m)	4	59	23,834	622	IRCM 73 / 112 M 4b			
Ø130	0,7	M8 (5m)	0,75	10	133,509	653	IRCM 83 / 80 M 4b		
	0,8	M8 (5m)	0,75	12	121,711	595	IRCM 83 / 80 M 4b		
	1,0	M8 (5m)	1,1	14	102,407	735	IRCM 83 / 90 S 4a		
	1,0	M8 (5m)	1,1	15	92,330	662	IRCM 83 / 90 S 4a		
	1,3	M8 (5m)	1,5	19	75,613	740	IRCM 83 / 90 L 4a		
	1,6	M8 (5m)	1,5	23	60,299	590	IRCM 83 / 90 L 4a		
	1,8	M8 (5m)	2,2	26	54,358	780	IRCM 83 / 100 L 4a		
	2,0	M8 (5m)	2,2	29	48,314	693	IRCM 83 / 100 L 4a		
	2,4	M8 (5m)	2,2	35	39,796	571	IRCM 83 / 100 L 4a		
	2,9	M8 (5m)	3	42	33,003	646	IRCM 83 / 100 L 4b		
	3,5	M8 (5m)	3	51	27,535	539	IRCM 83 / 100 L 4b		
	0,8	M8 (5m)	0,75	12	120,792	591	IRCM 73 / 80 M 4b		
	0,9	M8 (5m)	1,1	13	107,423	771	IRCM 73 / 90 S 4a		
	1,0	M8 (5m)	1,1	15	96,194	690	IRCM 73 / 90 S 4a		
	1,1	M8 (5m)	1,1	16	86,628	621	IRCM 73 / 90 S 4a		
	1,3	M8 (5m)	1,5	19	73,889	723	IRCM 73 / 90 L 4a		
	1,4	M8 (5m)	1,5	21	65,252	638	IRCM 73 / 90 L 4a		
	1,6	M8 (5m)	1,5	24	57,996	567	IRCM 73 / 90 L 4a		
	1,8	M7 (4m)	2,2	27	51,816	743	IRCM 73 / 100 L 4a		
	2,2	M7 (4m)	2,2	33	41,848	600	IRCM 73 / 100 L 4a		
	2,7	M7 (4m)	3	39	35,564	696	IRCM 73 / 100 L 4b		
	3,0	M7 (4m)	3	44	32,098	628	IRCM 73 / 100 L 4b		
	3,6	M7 (4m)	4	53	26,291	686	IRCM 73 / 112 M 4b		
	4,0	M7 (4m)	4	59	23,834	622	IRCM 73 / 112 M 4b		





D _T Tambur Çapı Drum Diameter <i>Diamètre de l'arbre</i> [mm]	V _h Kaldırma Hızı Lifting Speeds <i>Vitesse de levage</i> [m/min]	Vinç Sınıfı Crane Class <i>Classification de l'application de levage</i> ISO (FEM)	P ₁ Motor Gücü Power <i>Puissance</i> [kW]	n ₂ Çıkış Devri Output Speeds <i>Vitesse de sortie</i> [r.p.m]	i Tahvil Ratio <i>Rapport de réduction</i>	M ₂ Çıkış Momenti Output Torque <i>Couple de sortie</i>	Tip Type <i>Typ</i>		 kg
Ø140	0,7	M8 (5m)	0,75	10	133,509	653	IRCM 83 / 80 M 4b		
	0,9	M8 (5m)	1,1	12	121,711	873	IRCM 83 / 90 S 4a		
	1,0	M8 (5m)	1,1	14	102,407	735	IRCM 83 / 90 S 4a		
	1,1	M8 (5m)	1,1	15	92,330	662	IRCM 83 / 90 S 4a		
	1,4	M8 (5m)	1,5	19	75,613	740	IRCM 83 / 90 L 4a		
	1,7	M8 (5m)	1,5	23	60,299	590	IRCM 83 / 90 L 4a		
	1,9	M8 (5m)	2,2	26	54,358	780	IRCM 83 / 100 L 4a		
	2,1	M8 (5m)	2,2	29	48,314	693	IRCM 83 / 100 L 4a		
	2,6	M8 (5m)	3	35	39,796	779	IRCM 83 / 100 L 4b		
	3,1	M8 (5m)	3	42	33,003	646	IRCM 83 / 100 L 4b		
	3,7	M8 (5m)	4	51	27,535	718	IRCM 83 / 112 M 4b		
	0,9	M7 (4m)	1,1	12	120,792	866	IRCM 73 / 90 S 4a		
	1,0	M7 (4m)	1,1	13	107,423	771	IRCM 73 / 90 S 4a		
	1,1	M7 (4m)	1,1	15	96,194	690	IRCM 73 / 90 S 4a		
	1,2	M7 (4m)	1,1	16	86,628	621	IRCM 73 / 90 S 4a		
	1,4	M7 (4m)	1,5	19	73,889	723	IRCM 73 / 90 L 4a		
	1,5	M7 (4m)	1,5	21	65,252	638	IRCM 73 / 90 L 4a		
	1,8	M7 (4m)	2,2	24	57,996	832	IRCM 73 / 100 L 4a		
	2,0	M7 (4m)	2,2	27	51,816	743	IRCM 73 / 100 L 4a		
	2,4	M7 (4m)	2,2	33	41,848	600	IRCM 73 / 100 L 4a		
2,9	M7 (4m)	3	39	35,564	696	IRCM 73 / 100 L 4b			
3,2	M7 (4m)	3	44	32,098	628	IRCM 73 / 100 L 4b			
3,9	M7 (4m)	4	53	26,291	686	IRCM 73 / 112 M 4b			
4,3	M7 (4m)	4	59	23,834	622	IRCM 73 / 112 M 4b			
Ø150	0,8	M8 (5m)	0,75	10	133,509	653	IRCM 83 / 80 M 4b		
	0,9	M8 (5m)	1,1	12	121,711	873	IRCM 83 / 90 S 4a		
	1,1	M8 (5m)	1,1	14	102,407	735	IRCM 83 / 90 S 4a		
	1,2	M8 (5m)	1,1	15	92,330	662	IRCM 83 / 90 S 4a		
	1,5	M8 (5m)	1,5	19	75,613	740	IRCM 83 / 90 L 4a		
	1,8	M8 (5m)	2,2	23	60,299	865	IRCM 83 / 100 L 4a		
	2,0	M8 (5m)	2,2	26	54,358	780	IRCM 83 / 100 L 4a		
	2,3	M8 (5m)	2,2	29	48,314	693	IRCM 83 / 100 L 4a		
	2,7	M8 (5m)	3	35	39,796	779	IRCM 83 / 100 L 4b		
	3,3	M8 (5m)	3	42	33,003	646	IRCM 83 / 100 L 4b		
	4,0	M8 (5m)	4	51	27,535	718	IRCM 83 / 112 M 4b		
	0,9	M7 (4m)	1,1	12	120,792	866	IRCM 73 / 90 S 4a		
	1,0	M7 (4m)	1,1	13	107,423	771	IRCM 73 / 90 S 4a		
	1,2	M7 (4m)	1,1	15	96,194	690	IRCM 73 / 90 S 4a		
	1,3	M7 (4m)	1,1	16	86,628	621	IRCM 73 / 90 S 4a		
	1,5	M7 (4m)	1,5	19	73,889	723	IRCM 73 / 90 L 4a		
	1,6	M7 (4m)	1,5	21	65,252	638	IRCM 73 / 90 L 4a		
	1,9	M7 (4m)	2,2	24	57,996	832	IRCM 73 / 100 L 4a		
	2,1	M7 (4m)	2,2	27	51,816	743	IRCM 73 / 100 L 4a		
	2,6	M7 (4m)	3	33	41,848	819	IRCM 73 / 100 L 4b		
3,1	M7 (4m)	3	39	35,564	696	IRCM 73 / 100 L 4b			
3,5	M7 (4m)	3	44	32,098	628	IRCM 73 / 100 L 4b			
4,2	M7 (4m)	4	53	26,291	686	IRCM 73 / 112 M 4b			
4,6	M7 (4m)	4	59	23,834	622	IRCM 73 / 112 M 4b			



Vinç sistemleri kaldırma redüktörleri güç ve devir tabloları / Power and ratio table for hoisting applications / Tableau de classification des couples et rapports de réduction pour les applications de levage



Vinç sistemleri kaldırma redüktörleri güç ve devir tabloları / Power and ratio table for hoisting applications / Tableau de classification des couples et rapports de réduction pour les applications de levage



D _T Tambur Çapı Drum Diameter Diamètre de l'arbre [mm]	V _h Kaldırma Hızı Lifting Speeds Vitesse de levage [m/min]	Vinç Sınıfı Crane Class Classification de l'application de levage ISO (FEM)	P ₁ Motor Gücü Power Puissance [kW]	n ₂ Çıkış Devri Output Speeds Vitesse de sortie [r.p.m]	i Tahvil Ratio Rapport de réduction	M ₂ Çıkış Momenti Output Torque Couple de sortie	Tip Type Typ		 kg
Ø160	0,8	M8 (5m)	0,75	10	133,509	653	IRCM 83 / 80 M 4b		
	1,0	M8 (5m)	1,1	12	121,711	873	IRCM 83 / 90 S 4a		
	1,2	M8 (5m)	1,1	14	102,407	735	IRCM 83 / 90 S 4a		
	1,3	M8 (5m)	1,1	15	92,330	662	IRCM 83 / 90 S 4a		
	1,6	M8 (5m)	1,5	19	75,613	740	IRCM 83 / 90 L 4a		
	1,9	M8 (5m)	2,2	23	60,299	865	IRCM 83 / 100 L 4a		
	2,2	M8 (5m)	2,2	26	54,358	780	IRCM 83 / 100 L 4a		
	2,4	M8 (5m)	2,2	29	48,314	693	IRCM 83 / 100 L 4a		
	2,9	M8 (5m)	3	35	39,796	779	IRCM 83 / 100 L 4b		
	3,5	M8 (5m)	4	42	33,003	861	IRCM 83 / 112 M 4b		
	4,3	M8 (5m)	4	51	27,535	718	IRCM 83 / 112 M 4b		
	1,0	M7 (4m)	1,1	12	120,792	866	IRCM 73 / 90 S 4a		
	1,1	M7 (4m)	1,1	13	107,423	771	IRCM 73 / 90 S 4a		
	1,3	M7 (4m)	1,1	15	96,194	690	IRCM 73 / 90 S 4a		
	1,3	M7 (4m)	1,5	16	86,628	847	IRCM 73 / 90 L 4a		
	1,6	M7 (4m)	1,5	19	73,889	723	IRCM 73 / 90 L 4a		
	1,8	M7 (4m)	2,2	21	65,252	936	IRCM 73 / 100 L 4a		
	2,0	M7 (4m)	2,2	24	57,996	832	IRCM 73 / 100 L 4a		
	2,3	M7 (4m)	2,2	27	51,816	743	IRCM 73 / 100 L 4a		
	2,8	M7 (4m)	3	33	41,848	819	IRCM 73 / 100 L 4b		
3,3	M7 (4m)	3	39	35,564	696	IRCM 73 / 100 L 4b			
3,7	M6 (3m)	4	44	32,098	837	IRCM 73 / 112 M 4b			
4,4	M6 (3m)	4	53	26,291	686	IRCM 73 / 112 M 4b			
4,9	M6 (3m)	5,5	59	23,834	855	IRCM 73 / 132 S 4c			
Ø170	0,9	M8 (5m)	1,1	10	133,509	958	IRCM 83 / 90 S 4a		
	1,1	M8 (5m)	1,1	12	121,711	873	IRCM 83 / 90 S 4a		
	1,2	M8 (5m)	1,1	14	102,407	735	IRCM 83 / 90 S 4a		
	1,3	M8 (5m)	1,5	15	92,330	903	IRCM 83 / 90 L 4a		
	1,7	M8 (5m)	1,5	19	75,613	740	IRCM 83 / 90 L 4a		
	2,0	M8 (5m)	2,2	23	60,299	865	IRCM 83 / 100 L 4a		
	2,3	M8 (5m)	2,2	26	54,358	780	IRCM 83 / 100 L 4a		
	2,6	M8 (5m)	3	29	48,314	945	IRCM 83 / 100 L 4b		
	3,1	M8 (5m)	3	35	39,796	779	IRCM 83 / 100 L 4b		
	3,7	M8 (5m)	4	42	33,003	861	IRCM 83 / 112 M 4b		
	4,5	M8 (5m)	4	51	27,535	718	IRCM 83 / 112 M 4b		
	1,1	M7 (4m)	1,1	12	120,792	866	IRCM 73 / 90 S 4a		
	1,2	M7 (4m)	1,1	13	107,423	771	IRCM 73 / 90 S 4a		
	1,3	M7 (4m)	1,5	15	96,194	941	IRCM 73 / 90 L 4a		
	1,4	M6 (3m)	1,5	16	86,628	847	IRCM 73 / 90 L 4a		
	1,7	M6 (3m)	1,5	19	73,889	723	IRCM 73 / 90 L 4a		
	1,9	M6 (3m)	2,2	21	65,252	936	IRCM 73 / 100 L 4a		
	2,1	M6 (3m)	2,2	24	57,996	832	IRCM 73 / 100 L 4a		
	2,4	M6 (3m)	2,2	27	51,816	743	IRCM 73 / 100 L 4a		
	2,9	M6 (3m)	3	33	41,848	819	IRCM 73 / 100 L 4b		
3,5	M6 (3m)	3	39	35,564	696	IRCM 73 / 100 L 4b			
3,9	M6 (3m)	4	44	32,098	837	IRCM 73 / 112 M 4b			
4,7	M6 (3m)	5,5	53	26,291	943	IRCM 73 / 132 S 4c			
5,2	M6 (3m)	5,5	59	23,834	855	IRCM 73 / 132 S 4c			





D _T Tambur Çapı Drum Diameter <i>Diamètre de l'arbre</i> [mm]	V _h Kaldırma Hızı Lifting Speeds <i>Vitesse de levage</i> [m/min]	Vinç Sınıfı Crane Class <i>Classification de l'application de levage</i> ISO (FEM)	P ₁ Motor Gücü Power <i>Puissance</i> [kW]	n ₂ Çıkış Devri Output Speeds <i>Vitesse de sortie</i> [r.p.m]	i Tahvil Ratio <i>Rapport de réduction</i>	M ₂ Çıkış Momenti Output Torque <i>Couple de sortie</i>	Tip Type <i>Typ</i>		 kg
Ø180	0,9	M8 (5m)	1,1	10	133,509	958	IRCM 83 / 90 S 4a		
	1,1	M8 (5m)	1,1	12	121,711	873	IRCM 83 / 90 S 4a		
	1,3	M8 (5m)	1,5	14	102,407	1002	IRCM 83 / 90 L 4a		
	1,4	M8 (5m)	1,5	15	92,330	903	IRCM 83 / 90 L 4a		
	1,8	M8 (5m)	2,2	19	75,613	1085	IRCM 83 / 100 L 4a		
	2,2	M8 (5m)	2,2	23	60,299	865	IRCM 83 / 100 L 4a		
	2,4	M8 (5m)	2,2	26	54,358	780	IRCM 83 / 100 L 4a		
	2,7	M8 (5m)	3	29	48,314	945	IRCM 83 / 100 L 4b		
	3,3	M8 (5m)	3	35	39,796	779	IRCM 83 / 100 L 4b		
	4,0	M8 (5m)	4	42	33,003	861	IRCM 83 / 112 M 4b		
	4,8	M8 (5m)	5,5	51	27,535	988	IRCM 83 / 132 S 4c		
	1,1	M6 (3m)	1,1	12	120,792	866	IRCM 73 / 90 S 4a		
	1,2	M6 (3m)	1,1	13	107,423	771	IRCM 73 / 90 S 4a		
	1,4	M6 (3m)	1,5	15	96,194	941	IRCM 73 / 90 L 4a		
	1,5	M6 (3m)	1,5	16	86,628	847	IRCM 73 / 90 L 4a		
	1,8	M6 (3m)	2,2	19	73,889	1060	IRCM 73 / 100 L 4a		
	2,0	M6 (3m)	2,2	21	65,252	936	IRCM 73 / 100 L 4a		
	2,3	M6 (3m)	2,2	24	57,996	832	IRCM 73 / 100 L 4a		
	2,5	M6 (3m)	2,2	27	51,846	744	IRCM 73 / 100 L 4a		
	3,1	M6 (3m)	3	33	41,848	819	IRCM 73 / 100 L 4b		
3,7	M6 (3m)	4	39	35,564	928	IRCM 73 / 112 M 4b			
4,1	M6 (3m)	4	44	32,098	837	IRCM 73 / 112 M 4b			
Ø190	1,0	M8 (5m)	1,1	10	133,509	958	IRCM 83 / 90 S 4a		
	1,2	M8 (5m)	1,1	12	121,711	873	IRCM 83 / 90 S 4a		
	1,4	M8 (5m)	1,5	14	102,407	1002	IRCM 83 / 90 L 4a		
	1,5	M8 (5m)	1,5	15	92,330	903	IRCM 83 / 90 L 4a		
	1,9	M8 (5m)	2,2	19	75,613	1085	IRCM 83 / 100 L 4a		
	2,3	M8 (5m)	2,2	23	60,299	865	IRCM 83 / 100 L 4a		
	2,6	M8 (5m)	3	26	54,358	1063	IRCM 83 / 100 L 4b		
	2,9	M8 (5m)	3	29	48,314	945	IRCM 83 / 100 L 4b		
	3,5	M8 (5m)	3	35	39,796	779	IRCM 83 / 100 L 4b		
	4,2	M8 (5m)	4	42	33,003	861	IRCM 83 / 112 M 4b		
5,1	M8 (5m)	5,5	51	27,535	988	IRCM 83 / 132 S 4c			
Ø200	0,9	M8 (5m)	1,1	9	162,826	1168	IRCM 93 / 90 S 4a		
	1,0	M8 (5m)	1,1	10	146,946	1054	IRCM 93 / 90 S 4a		
	1,0	M8 (5m)	1,1	10	133,419	957	IRCM 93 / 90 S 4a		
	1,4	M8 (5m)	1,5	13	111,602	1092	IRCM 93 / 90 L 4a		
	1,7	M8 (5m)	1,5	16	87,936	860	IRCM 93 / 90 L 4a		
	1,0	M8 (5m)	1,1	10	133,509	958	IRCM 83 / 90 S 4a		
	1,3	M8 (5m)	1,1	12	121,711	873	IRCM 83 / 90 S 4a		
	1,5	M8 (5m)	1,5	14	102,407	1002	IRCM 83 / 90 L 4a		
	1,6	M8 (5m)	1,5	15	92,330	903	IRCM 83 / 90 L 4a		
	2,0	M8 (5m)	2,2	19	75,613	1085	IRCM 83 / 100 L 4a		
	2,4	M8 (5m)	2,2	23	60,299	865	IRCM 83 / 100 L 4a		
	2,7	M8 (5m)	3	26	54,358	1063	IRCM 83 / 100 L 4b		
	3,0	M8 (5m)	3	29	48,314	945	IRCM 83 / 100 L 4b		
	3,7	M8 (5m)	4	35	39,796	1038	IRCM 83 / 112 M 4b		
	4,4	M8 (5m)	4	42	33,003	861	IRCM 83 / 112 M 4b		
5,3	M8 (5m)	5,5	51	27,535	988	IRCM 83 / 132 S 4c			





Vinç sistemleri kaldırma redüktörleri güç ve devir tabloları / Power and ratio table for hoisting applications / Tableau de classification des couples et rapports de réduction pour les applications de levage

D _T Tambur Çapı Drum Diameter <i>Diamètre de l'arbre</i> [mm]	V _h Kaldırma Hızı Lifting Speeds <i>Vitesse de levage</i> [m/min]	Vinç Sınıfı Crane Class <i>Classification de l'application de levage</i> ISO (FEM)	P ₁ Motor Gücü Power <i>Puissance</i> [kW]	n ₂ Çıkış Devri Output Speeds <i>Vitesse de sortie</i> [r.p.m]	i Tahvil Ratio <i>Rapport de réduction</i>	M ₂ Çıkış Momenti Output Torque <i>Couple de sortie</i>	Tip Type <i>Typ</i>		 kg
Ø110	0,5	M8 (5m)	0,55	12	120,792	433	IRCM 73 / 80 M 4a		
	0,6	M8 (5m)	0,55	13	107,423	385	IRCM 73 / 80 M 4a		
	0,6	M8 (5m)	0,75	15	96,194	470	IRCM 73 / 80 M 4b		
	0,7	M8 (5m)	0,75	16	86,628	424	IRCM 73 / 80 M 4b		
	0,8	M8 (5m)	0,75	19	73,889	361	IRCM 73 / 80 M 4b		
	0,9	M8 (5m)	1,1	21	65,252	468	IRCM 73 / 90 S 4a		
	1,0	M8 (5m)	1,1	24	57,996	416	IRCM 73 / 90 S 4a		
	1,2	M8 (5m)	1,1	27	51,846	372	IRCM 73 / 90 S 4a		
	1,4	M8 (5m)	1,5	33	41,848	409	IRCM 73 / 90 L 4a		
	1,7	M8 (5m)	1,5	39	35,564	348	IRCM 73 / 90 L 4a		
	1,9	M8 (5m)	2,2	44	32,098	461	IRCM 73 / 100 L 4a		
	2,3	M8 (5m)	2,2	53	26,291	377	IRCM 73 / 100 L 4a		
2,5	M8 (5m)	2,2	59	23,834	342	IRCM 73 / 100 L 4a			
Ø120	0,6	M8 (5m)	0,55	12	120,792	433	IRCM 73 / 80 M 4a		
	0,6	M8 (5m)	0,55	13	107,423	385	IRCM 73 / 80 M 4a		
	0,7	M8 (5m)	0,75	15	96,194	470	IRCM 73 / 80 M 4b		
	0,8	M8 (5m)	0,75	16	86,628	424	IRCM 73 / 80 M 4b		
	0,9	M8 (5m)	1,1	19	73,889	530	IRCM 73 / 90 S 4a		
	1,0	M8 (5m)	1,1	21	65,252	468	IRCM 73 / 90 S 4a		
	1,1	M8 (5m)	1,1	24	57,996	416	IRCM 73 / 90 S 4a		
	1,3	M8 (5m)	1,1	27	51,846	372	IRCM 73 / 90 S 4a		
	1,6	M8 (5m)	1,5	33	41,848	409	IRCM 73 / 90 L 4a		
	1,8	M8 (5m)	2,2	39	35,564	510	IRCM 73 / 100 L 4a		
	2,1	M8 (5m)	2,2	44	32,098	461	IRCM 73 / 100 L 4a		
	2,5	M8 (5m)	2,2	53	26,291	377	IRCM 73 / 100 L 4a		
2,8	M8 (5m)	3	59	23,834	466	IRCM 73 / 100 L 4b			
Ø130	0,6	M8 (5m)	0,55	12	120,792	433	IRCM 73 / 80 M 4a		
	0,7	M8 (5m)	0,75	13	107,423	525	IRCM 73 / 80 M 4b		
	0,8	M8 (5m)	0,75	15	96,194	470	IRCM 73 / 80 M 4b		
	0,8	M8 (5m)	0,75	16	86,628	424	IRCM 73 / 80 M 4b		
	1,0	M8 (5m)	1,1	19	73,889	530	IRCM 73 / 90 S 4a		
	1,1	M8 (5m)	1,1	21	65,252	468	IRCM 73 / 90 S 4a		
	1,2	M8 (5m)	1,1	24	57,996	416	IRCM 73 / 90 S 4a		
	1,4	M8 (5m)	1,5	27	51,846	507	IRCM 73 / 90 L 4a		
	1,7	M8 (5m)	1,5	33	41,848	409	IRCM 73 / 90 L 4a		
	2,0	M8 (5m)	2,2	39	35,564	510	IRCM 73 / 100 L 4a		
	2,2	M8 (5m)	2,2	44	32,098	461	IRCM 73 / 100 L 4a		
	2,7	M8 (5m)	3	53	26,291	514	IRCM 73 / 100 L 4b		
3,0	M8 (5m)	3	59	23,834	466	IRCM 73 / 100 L 4b			
Ø140	0,7	M8 (5m)	0,75	12	120,792	591	IRCM 73 / 80 M 4b		
	0,7	M8 (5m)	0,75	13	107,423	525	IRCM 73 / 80 M 4b		
	0,8	M8 (5m)	0,75	15	96,194	470	IRCM 73 / 80 M 4b		
	0,9	M8 (5m)	1,1	16	86,628	621	IRCM 73 / 90 S 4a		
	1,0	M8 (5m)	1,1	19	73,889	530	IRCM 73 / 90 S 4a		
	1,2	M8 (5m)	1,1	21	65,252	468	IRCM 73 / 90 S 4a		
	1,3	M8 (5m)	1,5	24	57,996	567	IRCM 73 / 90 L 4a		
	1,5	M8 (5m)	1,5	27	51,846	507	IRCM 73 / 90 L 4a		
	1,8	M8 (5m)	2,2	33	41,848	600	IRCM 73 / 100 L 4a		
	2,1	M8 (5m)	2,2	39	35,564	510	IRCM 73 / 100 L 4a		
	2,4	M8 (5m)	2,2	44	32,098	461	IRCM 73 / 100 L 4a		
	2,9	M8 (5m)	3	53	26,291	514	IRCM 73 / 100 L 4b		
3,2	M8 (5m)	3	59	23,834	466	IRCM 73 / 100 L 4b			





D _T Tambur Çapı Drum Diameter <i>Diamètre de l'arbre</i> [mm]	V _h Kaldırma Hızı Lifting Speeds <i>Vitesse de levage</i> [m/min]	Vinç Sınıfı Crane Class <i>Classification de l'application de levage</i> ISO (FEM)	P ₁ Motor Gücü Power <i>Puissance</i> [kW]	n ₂ Çıkış Devri Output Speeds <i>Vitesse de sortie</i> [r.p.m]	i Tahvil Ratio <i>Rapport de réduction</i>	M ₂ Çıkış Momenti Output Torque <i>Couple de sortie</i>	Tip Type <i>Typ</i>		 kg
Ø150	0,7	M8 (5m)	0,75	12	120,792	591	IRCM 73 / 80 M 4b		
	0,8	M8 (5m)	0,75	13	107,423	525	IRCM 73 / 80 M 4b		
	0,9	M8 (5m)	1,1	15	96,194	690	IRCM 73 / 90 S 4a		
	0,9	M8 (5m)	1,1	16	86,628	621	IRCM 73 / 90 S 4a		
	1,1	M8 (5m)	1,1	19	73,889	530	IRCM 73 / 90 S 4a		
	1,2	M8 (5m)	1,1	21	65,252	468	IRCM 73 / 90 S 4a		
	1,4	M8 (5m)	1,5	24	57,996	567	IRCM 73 / 90 L 4a		
	1,6	M8 (5m)	1,5	27	51,846	507	IRCM 73 / 90 L 4a		
	1,9	M8 (5m)	2,2	33	41,848	600	IRCM 73 / 100 L 4a		
	2,3	M8 (5m)	2,2	39	35,564	510	IRCM 73 / 100 L 4a		
	2,6	M8 (5m)	3	44	32,098	628	IRCM 73 / 100 L 4b		
	3,1	M8 (5m)	3	53	26,291	514	IRCM 73 / 100 L 4b		
	3,5	M8 (5m)	3	59	23,834	466	IRCM 73 / 100 L 4b		
Ø160	0,8	M8 (5m)	0,75	12	120,792	591	IRCM 73 / 80 M 4b		
	0,8	M8 (5m)	0,75	13	107,423	525	IRCM 73 / 80 M 4b		
	0,9	M8 (5m)	1,1	15	96,194	690	IRCM 73 / 90 S 4a		
	1,0	M8 (5m)	1,1	16	86,628	621	IRCM 73 / 90 S 4a		
	1,2	M8 (5m)	1,1	19	73,889	530	IRCM 73 / 90 S 4a		
	1,3	M8 (5m)	1,5	21	65,252	638	IRCM 73 / 90 L 4a		
	1,5	M8 (5m)	1,5	24	57,996	567	IRCM 73 / 90 L 4a		
	1,7	M8 (5m)	1,5	27	51,846	507	IRCM 73 / 90 L 4a		
	2,1	M8 (5m)	2,2	33	41,848	600	IRCM 73 / 100 L 4a		
	2,4	M8 (5m)	2,2	39	35,564	510	IRCM 73 / 100 L 4a		
	2,8	M8 (5m)	3	44	32,098	628	IRCM 73 / 100 L 4b		
	3,3	M7 (4m)	3	53	26,291	514	IRCM 73 / 100 L 4b		
	3,7	M7 (4m)	4	59	23,834	622	IRCM 73 / 112 M 4b		
Ø170	0,8	M8 (5m)	0,75	12	120,792	591	IRCM 73 / 80 M 4b		
	0,9	M8 (5m)	0,75	13	107,423	525	IRCM 73 / 80 M 4b		
	1,0	M8 (5m)	1,1	15	96,194	690	IRCM 73 / 90 S 4a		
	1,1	M8 (5m)	1,1	16	86,628	621	IRCM 73 / 90 S 4a		
	1,3	M8 (5m)	1,1	19	73,889	530	IRCM 73 / 90 S 4a		
	1,4	M8 (5m)	1,5	21	65,252	638	IRCM 73 / 90 L 4a		
	1,6	M8 (5m)	1,5	24	57,996	567	IRCM 73 / 90 L 4a		
	1,8	M8 (5m)	2,2	27	51,846	744	IRCM 73 / 100 L 4a		
	2,2	M8 (5m)	2,2	33	41,848	600	IRCM 73 / 100 L 4a		
	2,6	M7 (4m)	3	39	35,564	696	IRCM 73 / 100 L 4b		
	2,9	M7 (4m)	3	44	32,098	628	IRCM 73 / 100 L 4b		
	3,5	M7 (4m)	4	53	26,291	686	IRCM 73 / 112 M 4b		
	3,9	M7 (4m)	4	59	23,834	622	IRCM 73 / 112 M 4b		
Ø180	0,8	M8 (5m)	0,75	12	120,792	591	IRCM 73 / 80 M 4b		
	0,9	M8 (5m)	1,1	13	107,423	771	IRCM 73 / 90 S 4a		
	1,1	M7 (4m)	1,1	15	96,194	690	IRCM 73 / 90 S 4a		
	1,1	M7 (4m)	1,1	16	86,628	621	IRCM 73 / 90 S 4a		
	1,3	M7 (4m)	1,5	19	73,889	723	IRCM 73 / 90 L 4a		
	1,5	M7 (4m)	1,5	21	65,252	638	IRCM 73 / 90 L 4a		
	1,7	M7 (4m)	1,5	24	57,996	567	IRCM 73 / 90 L 4a		
	1,9	M7 (4m)	2,2	27	51,846	744	IRCM 73 / 100 L 4a		
	2,3	M7 (4m)	2,2	33	41,848	600	IRCM 73 / 100 L 4a		
	2,8	M7 (4m)	3	39	35,564	696	IRCM 73 / 100 L 4b		
	3,1	M7 (4m)	3	44	32,098	628	IRCM 73 / 100 L 4b		
	3,7	M7 (4m)	4	53	26,291	686	IRCM 73 / 112 M 4b		
	4,2	M7 (4m)	4	59	23,834	622	IRCM 73 / 112 M 4b		





D _T Tambur Çapı Drum Diameter <i>Diamètre de l'arbre</i> [mm]	V _h Kaldırma Hızı Lifting Speeds <i>Vitesse de levage</i> [m/min]	Vinç Sınıfı Crane Class <i>Classification de l'application de levage</i> ISO (FEM)	P ₁ Motor Gücü Power <i>Puissance</i> [kW]	n ₂ Çıkış Devri Output Speeds <i>Vitesse de sortie</i> [r.p.m]	i Tahvil Ratio <i>Rapport de réduction</i>	M ₂ Çıkış Momenti Output Torque <i>Couple de sortie</i>	Tip Type <i>Typ</i>		 kg
Ø320	7,1	M6 (3m)	9,2	7,1	198,333	11899	IRCM 123 / 132 M 4c		
	8,7	M6 (3m)	11	8,7	161,000	11549	IRCM 123 / 160 M 4b		
	10	M6 (3m)	11	10	134,473	9646	IRCM 123 / 160 M 4b		
	12	M6 (3m)	15	12	118,333	11575	IRCM 123 / 160 L 4a		
	13	M6 (3m)	15	13	105,000	10271	IRCM 123 / 160 L 4a		
	15	M6 (3m)	18,5	15	93,800	11316	IRCM 123 / 180 M 4b		
	17	M6 (3m)	22	17	84,259	12088	IRCM 123 / 180 L 4b		
	19	M6 (3m)	22	19	73,179	10499	IRCM 123 / 180 L 4b		
	22	M6 (3m)	30	22	64,396	12598	IRCM 123 / 200 L 4c		
	25	M6 (3m)	30	25	57,140	11179	IRCM 123 / 200 L 4c		
	27	M6 (3m)	30	27	51,045	9986	IRCM 123 / 200 L 4c		
	31	M6 (3m)	37	31	45,853	11064	IRCM 123 / 225 S 4a		
	7,0	M4 (1Am)	9,2	7,0	199,476	11968	IRCM 103 / 132 M 4c		
	7,9	M4 (1Am)	9,2	7,9	177,284	10636	IRCM 103 / 132 M 4c		
	9,8	M4 (1Am)	11	10	143,552	10298	IRCM 103 / 160 M 4b		
	12,1	M4 (1Am)	15	12	119,126	11653	IRCM 103 / 160 L 4a		
	13,1	M4 (1Am)	15	13	109,276	10689	IRCM 103 / 160 L 4a		
	15,1	M4 (1Am)	18,5	15	95,896	11569	IRCM 103 / 180 M 4b		
	18,1	M4 (1Am)	22	18	78,692	11290	IRCM 103 / 180 L 4b		
	19,1	M4 (1Am)	22	19	71,869	10311	IRCM 103 / 180 L 4b		
24,1	M4 (1Am)	30	24	58,778	11499	IRCM 103 / 200 L 4c			
27,1	M3 (1Bm)	30	27	51,907	10155	IRCM 103 / 200 L 4c			
Ø340	7,6	M6 (3m)	9,2	7,1	198,333	11899	IRCM 123 / 132 M 4c		
	9,3	M6 (3m)	11	8,7	161,000	11549	IRCM 123 / 160 M 4b		
	11	M6 (3m)	15	10	134,473	13154	IRCM 123 / 160 L 4a		
	13	M6 (3m)	15	12	118,333	11575	IRCM 123 / 160 L 4a		
	14	M6 (3m)	18,5	13	105,000	12668	IRCM 123 / 180 M 4b		
	16	M6 (3m)	18,5	15	93,800	11316	IRCM 123 / 180 M 4b		
	18	M6 (3m)	22	17	84,259	12088	IRCM 123 / 180 L 4b		
	20	M6 (3m)	22	19	73,179	10499	IRCM 123 / 180 L 4b		
	23	M6 (3m)	30	22	64,396	12598	IRCM 123 / 200 L 4c		
	27	M6 (3m)	30	25	57,140	11179	IRCM 123 / 200 L 4c		
	29	M6 (3m)	37	27	51,045	12317	IRCM 123 / 225 S 4a		
	33	M6 (3m)	37	31	45,853	11064	IRCM 123 / 225 S 4a		
	7,5	M4 (1Am)	9,2	7,0	199,476	11968	IRCM 103 / 132 M 4c		
	8,4	M4 (1Am)	9,2	7,9	177,284	10636	IRCM 103 / 132 M 4c		
	10,5	M4 (1Am)	15	10	143,552	14042	IRCM 103 / 160 L 4a		
	12,8	M4 (1Am)	15	12	119,126	11653	IRCM 103 / 160 L 4a		
	13,9	M4 (1Am)	18,5	13	109,276	13183	IRCM 103 / 180 M 4b		
	16,0	M4 (1Am)	18,5	15	95,896	11569	IRCM 103 / 180 M 4b		
	19,2	M4 (1Am)	22	18	78,692	11290	IRCM 103 / 180 L 4b		
	20,3	M4 (1Am)	22	19	71,869	10311	IRCM 103 / 180 L 4b		
25,6	M3 (1Bm)	30	24	58,778	11499	IRCM 103 / 200 L 4c			
28,8	M3 (1Bm)	37	27	51,907	12525	IRCM 103 / 225 S 4a			
Ø360	8,0	M6 (3m)	9,2	7,1	198,333	11899	IRCM 123 / 132 M 4c		
	9,8	M6 (3m)	11	8,7	161,000	11549	IRCM 123 / 160 M 4b		
	11	M6 (3m)	15	10	134,473	13154	IRCM 123 / 160 L 4a		
	14	M6 (3m)	15	12	118,333	11575	IRCM 123 / 160 L 4a		
	15	M6 (3m)	18,5	13	105,000	12668	IRCM 123 / 180 M 4b		
	17	M6 (3m)	18,5	15	93,800	11316	IRCM 123 / 180 M 4b		
	19	M6 (3m)	22	17	84,259	12088	IRCM 123 / 180 L 4b		
	21	M6 (3m)	30	19	73,179	14317	IRCM 123 / 200 L 4c		
	25	M6 (3m)	30	22	64,396	12598	IRCM 123 / 200 L 4c		
	28	M6 (3m)	37	25	57,140	13787	IRCM 123 / 225 S 4a		
	31	M6 (3m)	37	27	51,045	12317	IRCM 123 / 225 S 4a		
	35	M5 (2m)	45	31	45,853	13456	IRCM 123 / 225 M 4c		





D _T Tambur Çapı Drum Diameter <i>Diamètre de l'arbre</i> [mm]	V _h Kaldırma Hızı Lifting Speeds <i>Vitesse de levage</i> [m/min]	Vinç Sınıfı Crane Class <i>Classification de l'application de levage</i> ISO (FEM)	P ₁ Motor Gücü Power <i>Puissance</i> [kW]	n ₂ Çıkış Devri Output Speeds <i>Vitesse de sortie</i> [r.p.m]	i Tahvil Ratio <i>Rapport de réduction</i>	M ₂ Çıkış Momenti Output Torque <i>Couple de sortie</i>	Tip Type <i>Typ</i>		 kg
Ø380	8,5	M6 (3m)	9,2	7,1	198,333	11899	IRCM 123 / 132 M 4c		
	10	M5 (2m)	15	8,7	161,000	15749	IRCM 123 / 160 L 4a		
	12	M5 (2m)	15	10	134,473	13154	IRCM 123 / 160 L 4a		
	14	M5 (2m)	18,5	12	118,333	14276	IRCM 123 / 180 M 4b		
	16	M5 (2m)	18,5	13	105,000	12668	IRCM 123 / 180 M 4b		
	18	M5 (2m)	22	15	93,800	13457	IRCM 123 / 180 L 4b		
	20	M5 (2m)	22	17	84,259	12088	IRCM 123 / 180 L 4b		
	23	M5 (2m)	30	19	73,179	14317	IRCM 123 / 200 L 4c		
	26	M5 (2m)	30	22	64,396	12598	IRCM 123 / 200 L 4c		
	30	M5 (2m)	37	25	57,140	13787	IRCM 123 / 225 S 4a		
	32	M5 (2m)	37	27	51,045	12317	IRCM 123 / 225 S 4a		
37	M5 (2m)	45	31	45,853	13456	IRCM 123 / 225 M 4c			
Ø400	8,9	M5 (2m)	11	7,1	198,333	14227	IRCM 123 / 160 M 4b		
	11	M5 (2m)	15	8,7	161,000	15749	IRCM 123 / 160 L 4a		
	13	M5 (2m)	15	10	134,473	13154	IRCM 123 / 160 L 4a		
	15	M5 (2m)	18,5	12	118,333	14276	IRCM 123 / 180 M 4b		
	16	M5 (2m)	18,5	13	105,000	12668	IRCM 123 / 180 M 4b		
	19	M5 (2m)	22	15	93,800	13457	IRCM 123 / 180 L 4b		
	21	M5 (2m)	30	17	84,259	16484	IRCM 123 / 200 L 4c		
	24	M5 (2m)	30	19	73,179	14317	IRCM 123 / 200 L 4c		
	28	M5 (2m)	30	22	64,396	12598	IRCM 123 / 200 L 4c		
	31	M5 (2m)	37	25	57,140	13787	IRCM 123 / 225 S 4a		
	34	M5 (2m)	37	27	51,045	12317	IRCM 123 / 225 S 4a		
39	M4 (1Am)	45	31	45,853	13456	IRCM 123 / 225 M 4c			
Ø420	9,4	M5 (2m)	11	7,1	198,333	14227	IRCM 123 / 160 M 4b		
	11	M4 (1Am)	15	8,7	161,000	15749	IRCM 123 / 160 L 4a		
	13	M4 (1Am)	15	10	134,473	13154	IRCM 123 / 160 L 4a		
	16	M4 (1Am)	18,5	12	118,333	14276	IRCM 123 / 180 M 4b		
	17	M4 (1Am)	22	13	105,000	15064	IRCM 123 / 180 L 4b		
	20	M4 (1Am)	22	15	93,800	13457	IRCM 123 / 180 L 4b		
	22	M4 (1Am)	30	17	84,259	16484	IRCM 123 / 200 L 4c		
	25	M4 (1Am)	30	19	73,179	14317	IRCM 123 / 200 L 4c		
	29	M4 (1Am)	37	22	64,396	15538	IRCM 123 / 225 S 4a		
	33	M4 (1Am)	37	25	57,140	13787	IRCM 123 / 225 S 4a		
	36	M4 (1Am)	45	27	51,045	14980	IRCM 123 / 225 M 4c		
Ø440	9,8	M4 (1Am)	11	7,1	198,333	14227	IRCM 123 / 160 M 4b		
	12	M4 (1Am)	15	8,7	161,000	15749	IRCM 123 / 160 L 4a		
	14	M4 (1Am)	15	10	134,473	13154	IRCM 123 / 160 L 4a		
	17	M4 (1Am)	18,5	12	118,333	14276	IRCM 123 / 180 M 4b		
	18	M4 (1Am)	22	13	105,000	15064	IRCM 123 / 180 L 4b		
	21	M4 (1Am)	30	15	93,800	18351	IRCM 123 / 200 L 4c		
	23	M4 (1Am)	30	17	84,259	16484	IRCM 123 / 200 L 4c		
	26	M4 (1Am)	30	19	73,179	14317	IRCM 123 / 200 L 4c		
	30	M4 (1Am)	37	22	64,396	15538	IRCM 123 / 225 S 4a		
	35	M4 (1Am)	45	25	57,140	16768	IRCM 123 / 225 M 4c		
	37	M4 (1Am)	45	27	51,045	14980	IRCM 123 / 225 M 4c		
43	M4 (1Am)	55	31	45,853	16446	IRCM 123 / 250 M 4c			





D _T Tambur Çapı Drum Diameter Diamètre de l'arbre [mm]	V _h Kaldırma Hızı Lifting Speeds Vitesse de levage [m/min]	Vinç Sınıfı Crane Class Classification de l'application de levage ISO (FEM)	P ₁ Motor Gücü Power Puissance [kW]	n ₂ Çıkış Devri Output Speeds Vitesse de sortie [r.p.m]	i Tahvil Ratio Rapport de réduction	M ₂ Çıkış Momenti Output Torque Couple de sortie	Tip Type Typ		 kg
Ø450	10	M4 (1Am)	11	7,1	198,333	14227	IRCM 123 / 160 M 4b		
	12	M4 (1Am)	15	8,7	161,000	15749	IRCM 123 / 160 L 4a		
	14	M4 (1Am)	18,5	10	134,473	16223	IRCM 123 / 180 M 4b		
	17	M4 (1Am)	18,5	12	118,333	14276	IRCM 123 / 180 M 4b		
	18	M4 (1Am)	22	13	105,000	15064	IRCM 123 / 180 L 4b		
	21	M4 (1Am)	30	15	93,800	18351	IRCM 123 / 200 L 4c		
	24	M4 (1Am)	30	17	84,259	16484	IRCM 123 / 200 L 4c		
	27	M4 (1Am)	30	19	73,179	14317	IRCM 123 / 200 L 4c		
	31	M4 (1Am)	37	22	64,396	15538	IRCM 123 / 225 S 4a		
	35	M4 (1Am)	45	25	57,140	16768	IRCM 123 / 225 M 4c		
	38	M4 (1Am)	45	27	51,045	14980	IRCM 123 / 225 M 4c		
44	M4 (1Am)	55	31	45,853	16446	IRCM 123 / 250 M 4c			





D _T Tambur Çapı Drum Diameter <i>Diamètre de l'arbre</i> [mm]	V _h Kaldırma Hızı Lifting Speeds <i>Vitesse de levage</i> [m/min]	Vinç Sınıfı Crane Class <i>Classification de l'application de levage</i> ISO (FEM)	P ₁ Motor Gücü Power <i>Puissance</i> [kW]	n ₂ Çıkış Devri Output Speeds <i>Vitesse de sortie</i> [r.p.m]	i Tahvil Ratio <i>Rapport de réduction</i>	M ₂ Çıkış Momenti Output Torque <i>Couple de sortie</i>	Tip Type <i>Typ</i>		 kg
Ø270	3,0	M8 (5m)	4	7,0	199,476	5203	IRCM 103 / 112 M 4b		
	3,3	M8 (5m)	4	7,9	177,284	4624	IRCM 103 / 112 M 4b		
	4,2	M8 (5m)	5,5	10	143,552	5149	IRCM 103 / 132 S 4c		
	5,1	M8 (5m)	7,5	12	119,126	5826	IRCM 103 / 132 M 4b		
	5,5	M8 (5m)	7,5	13	109,276	5345	IRCM 103 / 132 M 4b		
	6,4	M8 (5m)	7,5	15	95,896	4690	IRCM 103 / 132 M 4b		
	7,6	M8 (5m)	9,2	18	78,692	4721	IRCM 103 / 132 M 4c		
	8,1	M8 (5m)	9,2	19	71,869	4312	IRCM 103 / 132 M 4c		
	10,2	M8 (5m)	15	24	58,778	5750	IRCM 103 / 160 L 4a		
	11,4	M8 (5m)	15	27	51,907	5078	IRCM 103 / 160 L 4a		
	3,6	M5 (2m)	4	8,6	162,826	4247	IRCM 93 / 112 M 4b		
	4,0	M5 (2m)	5,5	9,5	146,946	5271	IRCM 93 / 132 S 4c		
	4,2	M5 (2m)	5,5	10	133,419	4785	IRCM 93 / 132 S 4c		
	5,5	M5 (2m)	7,5	13	111,602	5458	IRCM 93 / 132 M 4b		
	6,8	M5 (2m)	7,5	16	87,936	4301	IRCM 93 / 132 M 4b		
	7,6	M4 (1Am)	9,2	18	79,841	4790	IRCM 93 / 132 M 4c		
	8,9	M4 (1Am)	11	21	66,785	4791	IRCM 93 / 160 M 4b		
	9,7	M4 (1Am)	11	23	61,444	4408	IRCM 93 / 160 M 4b		
11	M4 (1Am)	15	26	54,545	5336	IRCM 93 / 160 L 4a			
13	M3 (1Bm)	15	31	44,753	4378	IRCM 93 / 160 L 4a			
16	M3 (1Bm)	18,5	38	37,199	4488	IRCM 93 / 180 M 4b			
Ø280	3,1	M8 (5m)	4	7,0	199,476	5203	IRCM 103 / 112 M 4b		
	3,5	M8 (5m)	4	7,9	177,284	4624	IRCM 103 / 112 M 4b		
	4,3	M8 (5m)	5,5	10	143,552	5149	IRCM 103 / 132 S 4c		
	5,3	M8 (5m)	7,5	12	119,126	5826	IRCM 103 / 132 M 4b		
	5,7	M8 (5m)	7,5	13	109,276	5345	IRCM 103 / 132 M 4b		
	6,6	M8 (5m)	7,5	15	95,896	4690	IRCM 103 / 132 M 4b		
	7,9	M8 (5m)	9,2	18	78,692	4721	IRCM 103 / 132 M 4c		
	8,4	M8 (5m)	9,2	19	71,869	4312	IRCM 103 / 132 M 4c		
	10,6	M8 (5m)	15	24	58,778	5750	IRCM 103 / 160 L 4a		
	11,9	M8 (5m)	15	27	51,907	5078	IRCM 103 / 160 L 4a		
	3,8	M5 (2m)	5,5	8,6	162,826	5840	IRCM 93 / 132 S 4c		
	4,2	M5 (2m)	5,5	9,5	146,946	5271	IRCM 93 / 132 S 4c		
	4,4	M5 (2m)	5,5	10	133,419	4785	IRCM 93 / 132 S 4c		
	5,7	M5 (2m)	7,5	13	111,602	5458	IRCM 93 / 132 M 4b		
	7,0	M4 (1Am)	9,2	16	87,936	5276	IRCM 93 / 132 M 4c		
	7,9	M4 (1Am)	9,2	18	79,841	4790	IRCM 93 / 132 M 4c		
	9,2	M4 (1Am)	11	21	66,785	4791	IRCM 93 / 160 M 4b		
	10	M4 (1Am)	11	23	61,444	4408	IRCM 93 / 160 M 4b		
11	M3 (1Bm)	15	26	54,545	5336	IRCM 93 / 160 L 4a			
Ø290	3,2	M8 (5m)	4	7,0	199,476	5203	IRCM 103 / 112 M 4b		
	3,6	M8 (5m)	4	7,9	177,284	4624	IRCM 103 / 112 M 4b		
	4,5	M8 (5m)	5,5	10	143,552	5149	IRCM 103 / 132 S 4c		
	5,5	M8 (5m)	7,5	12	119,126	5826	IRCM 103 / 132 M 4b		
	5,9	M8 (5m)	7,5	13	109,276	5345	IRCM 103 / 132 M 4b		
	6,8	M8 (5m)	7,5	15	95,896	4690	IRCM 103 / 132 M 4b		
	8,2	M8 (5m)	9,2	18	78,692	4721	IRCM 103 / 132 M 4c		
	8,7	M8 (5m)	11	19	71,869	5155	IRCM 103 / 160 M 4b		
	10,9	M8 (5m)	15	24	58,778	5750	IRCM 103 / 160 L 4a		
	12,3	M8 (5m)	15	27	51,907	5078	IRCM 103 / 160 L 4a		



Vinç sistemleri kaldırma redükörleri güç ve devir tabloları / Power and ratio table for hoisting applications / Tableau de classification des couples et rapports de réduction pour les applications de levage



D _T Tambur Çapı Drum Diameter <i>Diamètre de l'arbre</i> [mm]	V _h Kaldırma Hızı Lifting Speeds <i>Vitesse de levage</i> [m/min]	Vinç Sınıfı Crane Class <i>Classification de l'application de levage</i> ISO (FEM)	P ₁ Motor Gücü Power <i>Puissance</i> [kW]	n ₂ Çıkış Devri Output Speeds <i>Vitesse de sortie</i> [r.p.m]	i Tahvil Ratio <i>Rapport de réduction</i>	M ₂ Çıkış Momenti Output Torque <i>Couple de sortie</i>	Tip Type <i>Typ</i>		 kg
Ø300	3,3	M8 (5m)	4	7,0	199,476	5203	IRCM 103 / 112 M 4b		
	3,7	M8 (5m)	5,5	7,9	177,284	6359	IRCM 103 / 132 S 4c		
	4,6	M8 (5m)	5,5	10	143,552	5149	IRCM 103 / 132 S 4c		
	5,7	M8 (5m)	7,5	12	119,126	5826	IRCM 103 / 132 M 4b		
	6,1	M8 (5m)	7,5	13	109,276	5345	IRCM 103 / 132 M 4b		
	7,1	M8 (5m)	9,2	15	95,896	5753	IRCM 103 / 132 M 4c		
	8,5	M8 (5m)	9,2	18	78,692	4721	IRCM 103 / 132 M 4c		
	8,9	M8 (5m)	11	19	71,869	5155	IRCM 103 / 160 M 4b		
	11,3	M8 (5m)	15	24	58,778	5750	IRCM 103 / 160 L 4a		
Ø340	12,7	M8 (5m)	15	27	51,907	5078	IRCM 103 / 160 L 4a		
	3,8	M8 (5m)	5,5	7,1	198,333	7114	IRCM 123 / 132 S 4c		
	4,6	M8 (5m)	5,5	8,7	161,000	5775	IRCM 123 / 132 S 4c		
	5,3	M8 (5m)	7,5	10	134,473	6577	IRCM 123 / 132 M 4b		
	6,4	M8 (5m)	7,5	12	118,333	5788	IRCM 123 / 132 M 4b		
	6,9	M8 (5m)	9,2	13	105,000	6300	IRCM 123 / 132 M 4c		
	8,0	M8 (5m)	9,2	15	93,800	5628	IRCM 123 / 132 M 4c		
	9,1	M8 (5m)	11	17	84,259	6044	IRCM 123 / 160 M 4b		
	10	M8 (5m)	11	19	73,179	5249	IRCM 123 / 160 M 4b		
	12	M8 (5m)	15	22	64,396	6299	IRCM 123 / 160 L 4a		
Ø360	13	M8 (5m)	15	25	57,140	5589	IRCM 123 / 160 L 4a		
	14	M8 (5m)	18,5	27	51,045	6158	IRCM 123 / 180 M 4b		
	17	M8 (5m)	18,5	31	45,853	5532	IRCM 123 / 180 M 4b		
	4,0	M8 (5m)	5,5	7,1	198,333	7114	IRCM 123 / 132 S 4c		
	4,9	M8 (5m)	5,5	8,7	161,000	5775	IRCM 123 / 132 S 4c		
	5,7	M8 (5m)	7,5	10	134,473	6577	IRCM 123 / 132 M 4b		
	6,8	M8 (5m)	7,5	12	118,333	5788	IRCM 123 / 132 M 4b		
	7,3	M8 (5m)	9,2	13	105,000	6300	IRCM 123 / 132 M 4c		
	8,5	M8 (5m)	9,2	15	93,800	5628	IRCM 123 / 132 M 4c		
	9,6	M8 (5m)	11	17	84,259	6044	IRCM 123 / 160 M 4b		
	Ø380	11	M8 (5m)	15	19	73,179	7158	IRCM 123 / 160 L 4a	
12		M8 (5m)	15	22	64,396	6299	IRCM 123 / 160 L 4a		
14		M8 (5m)	18,5	25	57,140	6894	IRCM 123 / 180 M 4b		
15		M8 (5m)	18,5	27	51,045	6158	IRCM 123 / 180 M 4b		
18		M8 (5m)	22	31	45,853	6578	IRCM 123 / 180 L 4b		
4,2		M8 (5m)	5,5	7,1	198,333	7114	IRCM 123 / 132 S 4c		
5,2		M8 (5m)	7,5	8,7	161,000	7874	IRCM 123 / 132 M 4b		
6,0		M8 (5m)	7,5	10	134,473	6577	IRCM 123 / 132 M 4b		
7,2		M8 (5m)	9,2	12	118,333	7099	IRCM 123 / 132 M 4c		
7,8		M8 (5m)	9,2	13	105,000	6300	IRCM 123 / 132 M 4c		
8,9		M8 (5m)	11	15	93,800	6729	IRCM 123 / 160 M 4b		
10		M8 (5m)	11	17	84,259	6044	IRCM 123 / 160 M 4b		
11	M8 (5m)	15	19	73,179	7158	IRCM 123 / 160 L 4a			
13	M8 (5m)	15	22	64,396	6299	IRCM 123 / 160 L 4a			
15	M8 (5m)	18,5	25	57,140	6894	IRCM 123 / 180 M 4b			
16	M8 (5m)	18,5	27	51,045	6158	IRCM 123 / 180 M 4b			
18	M8 (5m)	22	31	45,853	6578	IRCM 123 / 180 L 4b			





D _T Tambur Çapı Drum Diameter <i>Diamètre de l'arbre</i> [mm]	V _h Kaldırma Hızı Lifting Speeds <i>Vitesse de levage</i> [m/min]	Vinç Sınıfı Crane Class <i>Classification de l'application de levage</i> ISO (FEM)	P ₁ Motor Gücü Power <i>Puissance</i> [kW]	n ₂ Çıkış Devri Output Speeds <i>Vitesse de sortie</i> [r.p.m]	i Tahvil Ratio <i>Rapport de réduction</i>	M ₂ Çıkış Momenti Output Torque <i>Couple de sortie</i>	Tip Type <i>Typ</i>		 kg
Ø170	1,1	M8 (5m)	1,5	8,6	162,826	1593	IRCM 93 / 90 L 4a		
	1,3	M8 (5m)	1,5	9,5	146,946	1437	IRCM 93 / 90 L 4a		
	1,3	M8 (5m)	1,5	10	133,419	1305	IRCM 93 / 90 L 4a		
	1,7	M8 (5m)	2,2	13	111,602	1601	IRCM 93 / 100 L 4a		
	2,1	M8 (5m)	3	16	87,936	1720	IRCM 93 / 100 L 4b		
	2,4	M8 (5m)	3	18	79,841	1562	IRCM 93 / 100 L 4b		
	2,8	M8 (5m)	4	21	66,785	1742	IRCM 93 / 112 M 4b		
	3,1	M8 (5m)	4	23	61,444	1603	IRCM 93 / 112 M 4b		
	3,5	M8 (5m)	4	26	54,545	1423	IRCM 93 / 112 M 4b		
	4,1	M8 (5m)	5,5	31	44,753	1605	IRCM 93 / 132 S 4c		
	5,1	M8 (5m)	5,5	38	37,199	1334	IRCM 93 / 132 S 4c		
	5,5	M8 (5m)	7,5	41	34,034	1665	IRCM 93 / 132 M 4b		
	6,0	M8 (5m)	7,5	45	31,194	1526	IRCM 93 / 132 M 4b		
	1,3	M7 (4m)	1,5	10	133,509	1306	IRCM 83 / 90 L 4a		
	1,6	M7 (4m)	2,2	12	121,711	1746	IRCM 83 / 100 L 4a		
	1,9	M7 (4m)	2,2	14	102,407	1469	IRCM 83 / 100 L 4a		
	2,0	M7 (4m)	2,2	15	92,330	1325	IRCM 83 / 100 L 4a		
	2,5	M7 (4m)	3	19	75,613	1479	IRCM 83 / 100 L 4b		
	3,1	M7 (4m)	4	23	60,299	1573	IRCM 83 / 112 M 4b		
	3,5	M7 (4m)	4	26	54,358	1418	IRCM 83 / 112 M 4b		
	3,9	M7 (4m)	5,5	29	48,314	1733	IRCM 83 / 132 S 4c		
	4,7	M6 (3m)	5,5	35	39,796	1427	IRCM 83 / 132 S 4c		
5,6	M6 (3m)	7,5	42	33,003	1614	IRCM 83 / 132 M 4b			
6,8	M6 (3m)	7,5	51	27,535	1347	IRCM 83 / 132 M 4b			
Ø180	1,2	M8 (5m)	1,5	8,6	162,826	1593	IRCM 93 / 90 L 4a		
	1,3	M8 (5m)	1,5	9,5	146,946	1437	IRCM 93 / 90 L 4a		
	1,4	M8 (5m)	2,2	10	133,419	1914	IRCM 93 / 100 L 4a		
	1,8	M8 (5m)	2,2	13	111,602	1601	IRCM 93 / 100 L 4a		
	2,3	M8 (5m)	3	16	87,936	1720	IRCM 93 / 100 L 4b		
	2,5	M8 (5m)	3	18	79,841	1562	IRCM 93 / 100 L 4b		
	3,0	M8 (5m)	4	21	66,785	1742	IRCM 93 / 112 M 4b		
	3,2	M8 (5m)	4	23	61,444	1603	IRCM 93 / 112 M 4b		
	3,7	M8 (5m)	4	26	54,545	1423	IRCM 93 / 112 M 4b		
	4,4	M8 (5m)	5,5	31	44,753	1605	IRCM 93 / 132 S 4c		
	5,4	M8 (5m)	7,5	38	37,199	1819	IRCM 93 / 132 M 4b		
	5,8	M8 (5m)	7,5	41	34,034	1665	IRCM 93 / 132 M 4b		
	6,4	M8 (5m)	7,5	45	31,194	1526	IRCM 93 / 132 M 4b		
	1,4	M7 (4m)	2,2	10	133,509	1915	IRCM 83 / 100 L 4a		
	1,7	M7 (4m)	2,2	12	121,711	1746	IRCM 83 / 100 L 4a		
	2,0	M7 (4m)	2,2	14	102,407	1469	IRCM 83 / 100 L 4a		
	2,1	M7 (4m)	3	15	92,330	1806	IRCM 83 / 100 L 4b		
	2,7	M6 (3m)	3	19	75,613	1479	IRCM 83 / 100 L 4b		
	3,2	M6 (3m)	4	23	60,299	1573	IRCM 83 / 112 M 4b		
	3,7	M6 (3m)	4	26	54,358	1418	IRCM 83 / 112 M 4b		
	4,1	M6 (3m)	5,5	29	48,314	1733	IRCM 83 / 132 S 4c		
	4,9	M6 (3m)	5,5	35	39,796	1427	IRCM 83 / 132 S 4c		
5,9	M6 (3m)	7,5	42	33,003	1614	IRCM 83 / 132 M 4b			
7,2	M6 (3m)	9,2	51	27,535	1652	IRCM 83 / 132 M 4c			



Vinç sistemleri kaldırma redüktörleri güç ve devir tabloları / Power and ratio table for hoisting applications / Tableau de classification des couples et rapports de réduction pour les applications de levage



D _T Tambur Çapı Drum Diameter <i>Diamètre de l'arbre</i> [mm]	V _h Kaldırma Hızı Lifting Speeds <i>Vitesse de levage</i> [m/min]	Vinç Sınıfı Crane Class <i>Classification de l'application de levage</i> ISO (FEM)	P ₁ Motor Gücü Power <i>Puissance</i> [kW]	n ₂ Çıkış Devri Output Speeds <i>Vitesse de sortie</i> [r.p.m]	i Tahvil Ratio <i>Rapport de réduction</i>	M ₂ Çıkış Momenti Output Torque <i>Couple de sortie</i>	Tip Type <i>Typ</i>		 kg
Ø190	1,3	M8 (5m)	1,5	8,6	162,826	1593	IRCM 93 / 90 L 4a		
	1,4	M8 (5m)	2,2	9,5	146,946	2108	IRCM 93 / 100 L 4a		
	1,5	M8 (5m)	2,2	10	133,419	1914	IRCM 93 / 100 L 4a		
	1,9	M8 (5m)	2,2	13	111,602	1601	IRCM 93 / 100 L 4a		
	2,4	M8 (5m)	3	16	87,936	1720	IRCM 93 / 100 L 4b		
	2,7	M8 (5m)	3	18	79,841	1562	IRCM 93 / 100 L 4b		
	3,1	M8 (5m)	4	21	66,785	1742	IRCM 93 / 112 M 4b		
	3,4	M8 (5m)	4	23	61,444	1603	IRCM 93 / 112 M 4b		
	3,9	M8 (5m)	5,5	26	54,545	1956	IRCM 93 / 132 S 4c		
	4,6	M8 (5m)	5,5	31	44,753	1605	IRCM 93 / 132 S 4c		
	5,7	M8 (5m)	7,5	38	37,199	1819	IRCM 93 / 132 M 4b		
	6,1	M8 (5m)	7,5	41	34,034	1665	IRCM 93 / 132 M 4b		
	6,7	M8 (5m)	7,5	45	31,194	1526	IRCM 93 / 132 M 4b		
	1,5	M6 (3m)	2,2	10	133,509	1915	IRCM 83 / 100 L 4a		
	1,8	M6 (3m)	2,2	12	121,711	1746	IRCM 83 / 100 L 4a		
	2,1	M6 (3m)	3	14	102,407	2003	IRCM 83 / 100 L 4b		
	2,2	M6 (3m)	3	15	92,330	1806	IRCM 83 / 100 L 4b		
	2,8	M6 (3m)	4	19	75,613	1972	IRCM 83 / 112 M 4b		
	3,4	M6 (3m)	4	23	60,299	1573	IRCM 83 / 112 M 4b		
	3,9	M6 (3m)	5,5	26	54,358	1950	IRCM 83 / 132 S 4c		
4,3	M6 (3m)	5,5	29	48,314	1733	IRCM 83 / 132 S 4c			
5,2	M6 (3m)	7,5	35	39,796	1946	IRCM 83 / 132 M 4b			
6,3	M5 (2m)	7,5	42	33,003	1614	IRCM 83 / 132 M 4b			
7,6	M5 (2m)	9,2	51	27,535	1652	IRCM 83 / 132 M 4c			
Ø200	1,4	M8 (5m)	1,5	8,6	162,826	1593	IRCM 93 / 90 L 4a		
	1,5	M8 (5m)	2,2	9,5	146,946	2108	IRCM 93 / 100 L 4a		
	1,6	M8 (5m)	2,2	10	133,419	1914	IRCM 93 / 100 L 4a		
	2,0	M8 (5m)	3	13	111,602	2183	IRCM 93 / 100 L 4b		
	2,5	M8 (5m)	3	16	87,936	1720	IRCM 93 / 100 L 4b		
	2,8	M8 (5m)	4	18	79,841	2083	IRCM 93 / 112 M 4b		
	3,3	M8 (5m)	4	21	66,785	1742	IRCM 93 / 112 M 4b		
	3,6	M8 (5m)	4	23	61,444	1603	IRCM 93 / 112 M 4b		
	4,1	M8 (5m)	5,5	26	54,545	1956	IRCM 93 / 132 S 4c		
	4,9	M8 (5m)	5,5	31	44,753	1605	IRCM 93 / 132 S 4c		
	6,0	M8 (5m)	7,5	38	37,199	1819	IRCM 93 / 132 M 4b		
	6,4	M8 (5m)	7,5	41	34,034	1665	IRCM 93 / 132 M 4b		
	7,1	M8 (5m)	9,2	45	31,194	1872	IRCM 93 / 132 M 4c		
	1,6	M6 (3m)	2,2	10	133,509	1915	IRCM 83 / 100 L 4a		
	1,9	M6 (3m)	2,2	12	121,711	1746	IRCM 83 / 100 L 4a		
	2,2	M6 (3m)	3	14	102,407	2003	IRCM 83 / 100 L 4b		
	2,4	M6 (3m)	3	15	92,330	1806	IRCM 83 / 100 L 4b		
	3,0	M6 (3m)	4	19	75,613	1972	IRCM 83 / 112 M 4b		
	3,6	M6 (3m)	4	23	60,299	1573	IRCM 83 / 112 M 4b		
	4,1	M6 (3m)	5,5	26	54,358	1950	IRCM 83 / 132 S 4c		
4,6	M6 (3m)	5,5	29	48,314	1733	IRCM 83 / 132 S 4c			
5,5	M5 (2m)	7,5	35	39,796	1946	IRCM 83 / 132 M 4b			
6,6	M5 (2m)	7,5	42	33,003	1614	IRCM 83 / 132 M 4b			
8,0	M5 (2m)	9,2	51	27,535	1652	IRCM 83 / 132 M 4c			





D _T Tambur Çapı Drum Diameter <i>Diamètre de l'arbre</i> [mm]	V _h Kaldırma Hızı Lifting Speeds <i>Vitesse de levage</i> [m/min]	Vinç Sınıfı Crane Class <i>Classification de l'application de levage</i> ISO (FEM)	P ₁ Motor Gücü Power <i>Puissance</i> [kW]	n ₂ Çıkış Devri Output Speeds <i>Vitesse de sortie</i> [r.p.m]	i Tahvil Ratio <i>Rapport de réduction</i>	M ₂ Çıkış Momenti Output Torque <i>Couple de sortie</i>	Tip Type <i>Typ</i>		 kg
Ø210	1,4	M8 (5m)	2,2	8,6	162,826	2336	IRCM 93 / 100 L 4a		
	1,6	M8 (5m)	2,2	9,5	146,946	2108	IRCM 93 / 100 L 4a		
	1,6	M8 (5m)	2,2	10	133,419	1914	IRCM 93 / 100 L 4a		
	2,1	M8 (5m)	3	13	111,602	2183	IRCM 93 / 100 L 4b		
	2,6	M8 (5m)	3	16	87,936	1720	IRCM 93 / 100 L 4b		
	3,0	M8 (5m)	4	18	79,841	2083	IRCM 93 / 112 M 4b		
	3,5	M8 (5m)	4	21	66,785	1742	IRCM 93 / 112 M 4b		
	3,8	M8 (5m)	5,5	23	61,444	2204	IRCM 93 / 132 S 4c		
	4,3	M8 (5m)	5,5	26	54,545	1956	IRCM 93 / 132 S 4c		
	5,1	M8 (5m)	7,5	31	44,753	2189	IRCM 93 / 132 M 4b		
	6,3	M8 (5m)	7,5	38	37,199	1819	IRCM 93 / 132 M 4b		
	6,8	M8 (5m)	7,5	41	34,034	1665	IRCM 93 / 132 M 4b		
7,4	M8 (5m)	9,2	45	31,194	1872	IRCM 93 / 132 M 4c			
Ø220	1,5	M8 (5m)	2,2	8,6	162,826	2336	IRCM 93 / 100 L 4a		
	1,6	M8 (5m)	2,2	9,5	146,946	2108	IRCM 93 / 100 L 4a		
	1,7	M8 (5m)	2,2	10	133,419	1914	IRCM 93 / 100 L 4a		
	2,2	M8 (5m)	3	13	111,602	2183	IRCM 93 / 100 L 4b		
	2,8	M8 (5m)	3	16	87,936	1720	IRCM 93 / 100 L 4b		
	3,1	M8 (5m)	4	18	79,841	2083	IRCM 93 / 112 M 4b		
	3,6	M8 (5m)	4	21	66,785	1742	IRCM 93 / 112 M 4b		
	4,0	M8 (5m)	5,5	23	61,444	2204	IRCM 93 / 132 S 4c		
	4,5	M8 (5m)	5,5	26	54,545	1956	IRCM 93 / 132 S 4c		
	5,4	M8 (5m)	7,5	31	44,753	2189	IRCM 93 / 132 M 4b		
	6,6	M8 (5m)	7,5	38	37,199	1819	IRCM 93 / 132 M 4b		
	7,1	M8 (5m)	9,2	41	34,034	2042	IRCM 93 / 132 M 4c		
7,8	M8 (5m)	9,2	45	31,194	1872	IRCM 93 / 132 M 4c			
Ø230	1,6	M8 (5m)	2,2	8,6	162,826	2336	IRCM 93 / 100 L 4a		
	1,7	M8 (5m)	2,2	9,5	146,946	2108	IRCM 93 / 100 L 4a		
	1,8	M8 (5m)	2,2	10	133,419	1914	IRCM 93 / 100 L 4a		
	2,3	M8 (5m)	3	13	111,602	2183	IRCM 93 / 100 L 4b		
	2,9	M8 (5m)	4	16	87,936	2294	IRCM 93 / 112 M 4b		
	3,2	M8 (5m)	4	18	79,841	2083	IRCM 93 / 112 M 4b		
	3,8	M8 (5m)	5,5	21	66,785	2395	IRCM 93 / 132 S 4c		
	4,2	M8 (5m)	5,5	23	61,444	2204	IRCM 93 / 132 S 4c		
	4,7	M8 (5m)	5,5	26	54,545	1956	IRCM 93 / 132 S 4c		
	5,6	M8 (5m)	7,5	31	44,753	2189	IRCM 93 / 132 M 4b		
	6,9	M8 (5m)	7,5	38	37,199	1819	IRCM 93 / 132 M 4b		
	7,4	M8 (5m)	9,2	41	34,034	2042	IRCM 93 / 132 M 4c		
8	M8 (5m)	9,2	45	31,194	1872	IRCM 93 / 132 M 4c			
Ø240	1,6	M8 (5m)	2,2	8,6	162,826	2336	IRCM 93 / 100 L 4a		
	1,8	M8 (5m)	2,2	9,5	146,946	2108	IRCM 93 / 100 L 4a		
	1,9	M8 (5m)	2,2	10	133,419	1914	IRCM 93 / 100 L 4a		
	2,4	M8 (5m)	3	13	111,602	2183	IRCM 93 / 100 L 4b		
	3,0	M8 (5m)	4	16	87,936	2294	IRCM 93 / 112 M 4b		
	3,4	M8 (5m)	4	18	79,841	2083	IRCM 93 / 112 M 4b		
	4,0	M8 (5m)	5,5	21	66,785	2395	IRCM 93 / 132 S 4c		
	4,3	M8 (5m)	5,5	23	61,444	2204	IRCM 93 / 132 S 4c		
	4,9	M8 (5m)	5,5	26	54,545	1956	IRCM 93 / 132 S 4c		
	5,8	M8 (5m)	7,5	31	44,753	2189	IRCM 93 / 132 M 4b		
	7,2	M8 (5m)	9,2	38	37,199	2232	IRCM 93 / 132 M 4c		
	7,7	M8 (5m)	9,2	41	34,034	2042	IRCM 93 / 132 M 4c		
8	M8 (5m)	9,2	45	31,194	1872	IRCM 93 / 132 M 4c			



Vinç sistemleri kaldırma redüktörleri güç ve devir tabloları / Power and ratio table for hoisting applications / Tableau de classification des couples et rapports de réduction pour les applications de levage



D _T Tambur Çapı Drum Diameter Diamètre de l'arbre [mm]	V _h Kaldırma Hızı Lifting Speeds Vitesse de levage [m/min]	Vinç Sınıfı Crane Class Classification de l'application de levage ISO (FEM)	P ₁ Motor Gücü Power Puissance [kW]	n ₂ Çıkış Devri Output Speeds Vitesse de sortie [r.p.m]	i Tahvil Ratio Rapport de réduction	M ₂ Çıkış Momenti Output Torque Couple de sortie	Tip Type Typ		 kg
Ø170	0,8	M8 (5m)	1,1	8,6	162,826	1168	IRCM 93 / 90 S 4a		
	0,8	M8 (5m)	1,1	9,5	146,946	1054	IRCM 93 / 90 S 4a		
	0,9	M8 (5m)	1,1	10	133,419	957	IRCM 93 / 90 S 4a		
	1,2	M8 (5m)	1,5	13	111,602	1092	IRCM 93 / 90 L 4a		
	1,4	M8 (5m)	2,2	16	87,936	1262	IRCM 93 / 100 L 4a		
	1,6	M8 (5m)	2,2	18	79,841	1145	IRCM 93 / 100 L 4a		
	1,9	M8 (5m)	2,2	21	66,785	958	IRCM 93 / 100 L 4a		
	2,0	M8 (5m)	3	23	61,444	1202	IRCM 93 / 100 L 4b		
	2,3	M8 (5m)	3	26	54,545	1067	IRCM 93 / 100 L 4b		
	2,8	M8 (5m)	3	31	44,753	876	IRCM 93 / 100 L 4b		
	3,4	M8 (5m)	4	38	37,199	970	IRCM 93 / 112 M 4b		
	3,6	M8 (5m)	4	41	34,034	888	IRCM 93 / 112 M 4b		
	4,0	M8 (5m)	5,5	45	31,194	1119	IRCM 93 / 132 S 4c		
	0,9	M8 (5m)	1,1	10	133,509	958	IRCM 83 / 90 S 4a		
	1,1	M8 (5m)	1,5	12	121,711	1191	IRCM 83 / 90 L 4a		
	1,2	M8 (5m)	1,5	14	102,407	1002	IRCM 83 / 90 L 4a		
	1,3	M8 (5m)	1,5	15	92,330	903	IRCM 83 / 90 L 4a		
	1,7	M8 (5m)	2,2	19	75,613	1085	IRCM 83 / 100 L 4a		
	2,0	M8 (5m)	3	23	60,299	1180	IRCM 83 / 100 L 4b		
	2,3	M8 (5m)	3	26	54,358	1063	IRCM 83 / 100 L 4b		
2,6	M8 (5m)	3	29	48,314	945	IRCM 83 / 100 L 4b			
3,1	M8 (5m)	4	35	39,796	1038	IRCM 83 / 112 M 4b			
3,7	M8 (5m)	5,5	42	33,003	1184	IRCM 83 / 132 S 4c			
4,5	M8 (5m)	5,5	51	27,535	988	IRCM 83 / 132 S 4c			
Ø180	0,8	M8 (5m)	1,1	8,6	162,826	1168	IRCM 93 / 90 S 4a		
	0,9	M8 (5m)	1,1	9,5	146,946	1054	IRCM 93 / 90 S 4a		
	0,9	M8 (5m)	1,1	10	133,419	957	IRCM 93 / 90 S 4a		
	1,2	M8 (5m)	1,5	13	111,602	1092	IRCM 93 / 90 L 4a		
	1,5	M8 (5m)	2,2	16	87,936	1262	IRCM 93 / 100 L 4a		
	1,7	M8 (5m)	2,2	18	79,841	1145	IRCM 93 / 100 L 4a		
	2,0	M8 (5m)	2,2	21	66,785	958	IRCM 93 / 100 L 4a		
	2,2	M8 (5m)	3	23	61,444	1202	IRCM 93 / 100 L 4b		
	2,4	M8 (5m)	3	26	54,545	1067	IRCM 93 / 100 L 4b		
	2,9	M8 (5m)	4	31	44,753	1167	IRCM 93 / 112 M 4b		
	3,6	M8 (5m)	4	38	37,199	970	IRCM 93 / 112 M 4b		
	3,9	M8 (5m)	5,5	41	34,034	1221	IRCM 93 / 132 S 4c		
	4,2	M8 (5m)	5,5	45	31,194	1119	IRCM 93 / 132 S 4c		
	0,9	M8 (5m)	1,1	10	133,509	958	IRCM 83 / 90 S 4a		
	1,1	M8 (5m)	1,5	12	121,711	1191	IRCM 83 / 90 L 4a		
	1,3	M8 (5m)	1,5	14	102,407	1002	IRCM 83 / 90 L 4a		
	1,4	M8 (5m)	2,2	15	92,330	1325	IRCM 83 / 100 L 4a		
	1,8	M8 (5m)	2,2	19	75,613	1085	IRCM 83 / 100 L 4a		
	2,2	M8 (5m)	3	23	60,299	1180	IRCM 83 / 100 L 4b		
	2,4	M8 (5m)	3	26	54,358	1063	IRCM 83 / 100 L 4b		
2,7	M8 (5m)	3	29	48,314	945	IRCM 83 / 100 L 4b			
3,3	M8 (5m)	4	35	39,796	1038	IRCM 83 / 112 M 4b			
4,0	M7 (4m)	5,5	42	33,003	1184	IRCM 83 / 132 S 4c			
4,8	M7 (4m)	5,5	51	27,535	988	IRCM 83 / 132 S 4c			





D _T Tambur Çapı Drum Diameter <i>Diamètre de l'arbre</i> [mm]	V _h Kaldırma Hızı Lifting Speeds <i>Vitesse de levage</i> [m/min]	Vinç Sınıfı Crane Class <i>Classification de l'application de levage</i> ISO (FEM)	P ₁ Motor Gücü Power <i>Puissance</i> [kW]	n ₂ Çıkış Devri Output Speeds <i>Vitesse de sortie</i> [r.p.m]	i Tahvil Ratio <i>Rapport de réduction</i>	M ₂ Çıkış Momenti Output Torque <i>Couple de sortie</i>	Tip Type <i>Typ</i>		 kg
Ø190	0,9	M8 (5m)	1,1	8,6	162,826	1168	IRCM 93 / 90 S 4a		
	0,9	M8 (5m)	1,1	9,5	146,946	1054	IRCM 93 / 90 S 4a		
	1,0	M8 (5m)	1,1	10	133,419	957	IRCM 93 / 90 S 4a		
	1,3	M8 (5m)	1,5	13	111,602	1092	IRCM 93 / 90 L 4a		
	1,6	M8 (5m)	2,2	16	87,936	1262	IRCM 93 / 100 L 4a		
	1,8	M8 (5m)	2,2	18	79,841	1145	IRCM 93 / 100 L 4a		
	2,1	M8 (5m)	3	21	66,785	1307	IRCM 93 / 100 L 4b		
	2,3	M8 (5m)	3	23	61,444	1202	IRCM 93 / 100 L 4b		
	2,6	M8 (5m)	3	26	54,545	1067	IRCM 93 / 100 L 4b		
	3,1	M8 (5m)	4	31	44,753	1167	IRCM 93 / 112 M 4b		
	3,8	M8 (5m)	5,5	38	37,199	1334	IRCM 93 / 132 S 4c		
	4,1	M8 (5m)	5,5	41	34,034	1221	IRCM 93 / 132 S 4c		
	4,5	M8 (5m)	5,5	45	31,194	1119	IRCM 93 / 132 S 4c		
	1,0	M8 (5m)	1,1	10	133,509	958	IRCM 83 / 90 S 4a		
	1,2	M8 (5m)	1,5	12	121,711	1191	IRCM 83 / 90 L 4a		
	1,4	M8 (5m)	2,2	14	102,407	1469	IRCM 83 / 100 L 4a		
	1,5	M8 (5m)	2,2	15	92,330	1325	IRCM 83 / 100 L 4a		
	1,9	M8 (5m)	2,2	19	75,613	1085	IRCM 83 / 100 L 4a		
	2,3	M8 (5m)	3	23	60,299	1180	IRCM 83 / 100 L 4b		
	2,6	M8 (5m)	3	26	54,358	1063	IRCM 83 / 100 L 4b		
	2,9	M8 (5m)	4	29	48,314	1260	IRCM 83 / 112 M 4b		
	3,5	M7 (4m)	4	35	39,796	1038	IRCM 83 / 112 M 4b		
4,2	M7 (4m)	5,5	42	33,003	1184	IRCM 83 / 132 S 4c			
5,1	M7 (4m)	5,5	51	27,535	988	IRCM 83 / 132 S 4c			
Ø200	0,9	M8 (5m)	1,1	8,6	162,826	1168	IRCM 93 / 90 S 4a		
	1,0	M8 (5m)	1,1	9,5	146,946	1054	IRCM 93 / 90 S 4a		
	1,0	M8 (5m)	1,5	10	133,419	1305	IRCM 93 / 90 L 4a		
	1,4	M8 (5m)	1,5	13	111,602	1092	IRCM 93 / 90 L 4a		
	1,7	M8 (5m)	2,2	16	87,936	1262	IRCM 93 / 100 L 4a		
	1,9	M8 (5m)	2,2	18	79,841	1145	IRCM 93 / 100 L 4a		
	2,2	M8 (5m)	3	21	66,785	1307	IRCM 93 / 100 L 4b		
	2,4	M8 (5m)	3	23	61,444	1202	IRCM 93 / 100 L 4b		
	2,7	M8 (5m)	3	26	54,545	1067	IRCM 93 / 100 L 4b		
	3,2	M8 (5m)	4	31	44,753	1167	IRCM 93 / 112 M 4b		
	4,0	M8 (5m)	5,5	38	37,199	1334	IRCM 93 / 132 S 4c		
	4,3	M8 (5m)	5,5	41	34,034	1221	IRCM 93 / 132 S 4c		
	4,7	M8 (5m)	5,5	45	31,194	1119	IRCM 93 / 132 S 4c		
	1,0	M8 (5m)	1,5	10	133,509	1306	IRCM 83 / 90 L 4a		
	1,3	M8 (5m)	1,5	12	121,711	1191	IRCM 83 / 90 L 4a		
	1,5	M8 (5m)	2,2	14	102,407	1469	IRCM 83 / 100 L 4a		
	1,6	M8 (5m)	2,2	15	92,330	1325	IRCM 83 / 100 L 4a		
	2,0	M7 (4m)	2,2	19	75,613	1085	IRCM 83 / 100 L 4a		
	2,4	M7 (4m)	3	23	60,299	1180	IRCM 83 / 100 L 4b		
	2,7	M7 (4m)	3	26	54,358	1063	IRCM 83 / 100 L 4b		
	3,0	M7 (4m)	4	29	48,314	1260	IRCM 83 / 112 M 4b		
	3,7	M7 (4m)	4	35	39,796	1038	IRCM 83 / 112 M 4b		
4,4	M7 (4m)	5,5	42	33,003	1184	IRCM 83 / 132 S 4c			
5,3	M7 (4m)	7,5	51	27,535	1347	IRCM 83 / 132 M 4b			



Vinç sistemleri kaldırma redüktörleri güç ve devir tabloları / Power and ratio table for hoisting applications / Tableau de classification des couples et rapports de réduction pour les applications de levage



D _T Tambur Çapı Drum Diameter Diamètre de l'arbre [mm]	V _h Kaldırma Hızı Lifting Speeds Vitesse de levage [m/min]	Vinç Sınıfı Crane Class Classification de l'application de levage ISO (FEM)	P ₁ Motor Gücü Power Puissance [kW]	n ₂ Çıkış Devri Output Speeds Vitesse de sortie [r.p.m]	i Tahvil Ratio Rapport de réduction	M ₂ Çıkış Momenti Output Torque Couple de sortie	Tip Type Typ		 kg
Ø210	0,9	M8 (5m)	1,1	8,6	162,826	1168	IRCM 93 / 90 S 4a		
	1,0	M8 (5m)	1,5	9,5	146,946	1437	IRCM 93 / 90 L 4a		
	1,1	M8 (5m)	1,5	10	133,419	1305	IRCM 93 / 90 L 4a		
	1,4	M8 (5m)	2,2	13	111,602	1601	IRCM 93 / 100 L 4a		
	1,8	M8 (5m)	2,2	16	87,936	1262	IRCM 93 / 100 L 4a		
	2,0	M8 (5m)	2,2	18	79,841	1145	IRCM 93 / 100 L 4a		
	2,3	M8 (5m)	3	21	66,785	1307	IRCM 93 / 100 L 4b		
	2,5	M8 (5m)	3	23	61,444	1202	IRCM 93 / 100 L 4b		
	2,9	M8 (5m)	4	26	54,545	1423	IRCM 93 / 112 M 4b		
	3,4	M8 (5m)	4	31	44,753	1167	IRCM 93 / 112 M 4b		
	4,2	M8 (5m)	5,5	38	37,199	1334	IRCM 93 / 132 S 4c		
	4,5	M8 (5m)	5,5	41	34,034	1221	IRCM 93 / 132 S 4c		
	4,9	M8 (5m)	5,5	45	31,194	1119	IRCM 93 / 132 S 4c		
	1,1	M7 (4m)	1,5	10	133,509	1306	IRCM 83 / 90 L 4a		
	1,3	M7 (4m)	1,5	12	121,711	1191	IRCM 83 / 90 L 4a		
	1,5	M7 (4m)	2,2	14	102,407	1469	IRCM 83 / 100 L 4a		
	1,6	M7 (4m)	2,2	15	92,330	1325	IRCM 83 / 100 L 4a		
	2,1	M7 (4m)	3	19	75,613	1479	IRCM 83 / 100 L 4b		
	2,5	M7 (4m)	3	23	60,299	1180	IRCM 83 / 100 L 4b		
	2,9	M7 (4m)	4	26	54,358	1418	IRCM 83 / 112 M 4b		
3,2	M7 (4m)	4	29	48,314	1260	IRCM 83 / 112 M 4b			
3,8	M7 (4m)	5,5	35	39,796	1427	IRCM 83 / 132 S 4c			
4,6	M7 (4m)	5,5	42	33,003	1184	IRCM 83 / 132 S 4c			
5,6	M7 (4m)	7,5	51	27,535	1347	IRCM 83 / 132 M 4b			
Ø220	1,0	M8 (5m)	1,1	8,6	162,826	1168	IRCM 93 / 90 S 4a		
	1,1	M8 (5m)	1,5	9,5	146,946	1437	IRCM 93 / 90 L 4a		
	1,2	M8 (5m)	1,5	10	133,419	1305	IRCM 93 / 90 L 4a		
	1,5	M8 (5m)	2,2	13	111,602	1601	IRCM 93 / 100 L 4a		
	1,8	M8 (5m)	2,2	16	87,936	1262	IRCM 93 / 100 L 4a		
	2,1	M8 (5m)	3	18	79,841	1562	IRCM 93 / 100 L 4b		
	2,4	M8 (5m)	3	21	66,785	1307	IRCM 93 / 100 L 4b		
	2,6	M8 (5m)	3	23	61,444	1202	IRCM 93 / 100 L 4b		
	3,0	M8 (5m)	4	26	54,545	1423	IRCM 93 / 112 M 4b		
	3,6	M8 (5m)	4	31	44,753	1167	IRCM 93 / 112 M 4b		
	4,4	M8 (5m)	5,5	38	37,199	1334	IRCM 93 / 132 S 4c		
	4,7	M8 (5m)	5,5	41	34,034	1221	IRCM 93 / 132 S 4c		
	5,2	M8 (5m)	7,5	45	31,194	1526	IRCM 93 / 132 M 4b		
	1,2	M7 (4m)	1,5	10	133,509	1306	IRCM 83 / 90 L 4a		
	1,4	M7 (4m)	1,5	12	121,711	1191	IRCM 83 / 90 L 4a		
	1,6	M7 (4m)	2,2	14	102,407	1469	IRCM 83 / 100 L 4a		
	1,7	M7 (4m)	2,2	15	92,330	1325	IRCM 83 / 100 L 4a		
	2,2	M7 (4m)	3	19	75,613	1479	IRCM 83 / 100 L 4b		
	2,6	M7 (4m)	3	23	60,299	1180	IRCM 83 / 100 L 4b		
	3,0	M7 (4m)	4	26	54,358	1418	IRCM 83 / 112 M 4b		
3,3	M7 (4m)	4	29	48,314	1260	IRCM 83 / 112 M 4b			
4,0	M7 (4m)	5,5	35	39,796	1427	IRCM 83 / 132 S 4c			
4,8	M7 (4m)	5,5	42	33,003	1184	IRCM 83 / 132 S 4c			
5,9	M7 (4m)	7,5	51	27,535	1347	IRCM 83 / 132 M 4b			





D _T Tambur Çapı Drum Diameter <i>Diamètre de l'arbre</i> [mm]	V _h Kaldırma Hızı Lifting Speeds <i>Vitesse de levage</i> [m/min]	Vinç Sınıfı Crane Class <i>Classification de l'application de levage</i> ISO (FEM)	P ₁ Motor Gücü Power <i>Puissance</i> [kW]	n ₂ Çıkış Devri Output Speeds <i>Vitesse de sortie</i> [r.p.m]	i Tahvil Ratio <i>Rapport de réduction</i>	M ₂ Çıkış Momenti Output Torque <i>Couple de sortie</i>	Tip Type <i>Typ</i>		 kg
Ø230	1,0	M8 (5m)	1,5	8,6	162,826	1593	IRCM 93 / 90 L 4a		
	1,1	M8 (5m)	1,5	9,5	146,946	1437	IRCM 93 / 90 L 4a		
	1,2	M8 (5m)	1,5	10	133,419	1305	IRCM 93 / 90 L 4a		
	1,6	M8 (5m)	2,2	13	111,602	1601	IRCM 93 / 100 L 4a		
	1,9	M8 (5m)	2,2	16	87,936	1262	IRCM 93 / 100 L 4a		
	2,2	M8 (5m)	3	18	79,841	1562	IRCM 93 / 100 L 4b		
	2,5	M8 (5m)	3	21	66,785	1307	IRCM 93 / 100 L 4b		
	2,8	M8 (5m)	3	23	61,444	1202	IRCM 93 / 100 L 4b		
	3,1	M8 (5m)	4	26	54,545	1423	IRCM 93 / 112 M 4b		
	3,7	M8 (5m)	5,5	31	44,753	1605	IRCM 93 / 132 S 4c		
	4,6	M8 (5m)	5,5	38	37,199	1334	IRCM 93 / 132 S 4c		
	4,9	M8 (5m)	5,5	41	34,034	1221	IRCM 93 / 132 S 4c		
	5,4	M8 (5m)	7,5	45	31,194	1526	IRCM 93 / 132 M 4b		
	1,2	M7 (4m)	1,5	10	133,509	1306	IRCM 83 / 90 L 4a		
	1,4	M7 (4m)	2,2	12	121,711	1746	IRCM 83 / 100 L 4a		
	1,7	M7 (4m)	2,2	14	102,407	1469	IRCM 83 / 100 L 4a		
	1,8	M7 (4m)	2,2	15	92,330	1325	IRCM 83 / 100 L 4a		
	2,3	M7 (4m)	3	19	75,613	1479	IRCM 83 / 100 L 4b		
	2,8	M7 (4m)	3	23	60,299	1180	IRCM 83 / 100 L 4b		
	3,1	M7 (4m)	4	26	54,358	1418	IRCM 83 / 112 M 4b		
	3,5	M7 (4m)	4	29	48,314	1260	IRCM 83 / 112 M 4b		
	4,2	M7 (4m)	5,5	35	39,796	1427	IRCM 83 / 132 S 4c		
5,1	M6 (3m)	5,5	42	33,003	1184	IRCM 83 / 132 S 4c			
6,1	M6 (3m)	7,5	51	27,535	1347	IRCM 83 / 132 M 4b			
Ø240	1,1	M8 (5m)	1,5	8,6	162,826	1593	IRCM 93 / 90 L 4a		
	1,2	M8 (5m)	1,5	9,5	146,946	1437	IRCM 93 / 90 L 4a		
	1,3	M8 (5m)	1,5	10	133,419	1305	IRCM 93 / 90 L 4a		
	1,6	M8 (5m)	2,2	13	111,602	1601	IRCM 93 / 100 L 4a		
	2,0	M8 (5m)	2,2	16	87,936	1262	IRCM 93 / 100 L 4a		
	2,3	M8 (5m)	3	18	79,841	1562	IRCM 93 / 100 L 4b		
	2,6	M8 (5m)	3	21	66,785	1307	IRCM 93 / 100 L 4b		
	2,9	M8 (5m)	4	23	61,444	1603	IRCM 93 / 112 M 4b		
	3,3	M8 (5m)	4	26	54,545	1423	IRCM 93 / 112 M 4b		
	3,9	M8 (5m)	5,5	31	44,753	1605	IRCM 93 / 132 S 4c		
	4,8	M8 (5m)	5,5	38	37,199	1334	IRCM 93 / 132 S 4c		
	5,1	M8 (5m)	7,5	41	34,034	1665	IRCM 93 / 132 M 4b		
	5,7	M8 (5m)	7,5	45	31,194	1526	IRCM 93 / 132 M 4b		
	1,3	M7 (4m)	1,5	10	133,509	1306	IRCM 83 / 90 L 4a		
	1,5	M7 (4m)	2,2	12	121,711	1746	IRCM 83 / 100 L 4a		
	1,8	M7 (4m)	2,2	14	102,407	1469	IRCM 83 / 100 L 4a		
	1,9	M7 (4m)	2,2	15	92,330	1325	IRCM 83 / 100 L 4a		
	2,4	M7 (4m)	3	19	75,613	1479	IRCM 83 / 100 L 4b		
	2,9	M7 (4m)	4	23	60,299	1573	IRCM 83 / 112 M 4b		
	3,3	M7 (4m)	4	26	54,358	1418	IRCM 83 / 112 M 4b		
	3,6	M7 (4m)	4	29	48,314	1260	IRCM 83 / 112 M 4b		
	4,4	M6 (3m)	5,5	35	39,796	1427	IRCM 83 / 132 S 4c		
5,3	M6 (3m)	7,5	42	33,003	1614	IRCM 83 / 132 M 4b			
6,4	M6 (3m)	7,5	51	27,535	1347	IRCM 83 / 132 M 4b			



Vinç sistemleri kaldırma redüktörleri güç ve devir tabloları / Power and ratio table for hoisting applications / Tableau de classification des couples et rapports de réduction pour les applications de levage



D _T Tambur Çapı Drum Diameter <i>Diamètre de l'arbre</i> [mm]	V _h Kaldırma Hızı Lifting Speeds <i>Vitesse de levage</i> [m/min]	Vinç Sınıfı Crane Class <i>Classification de l'application de levage</i> ISO (FEM)	P ₁ Motor Gücü Power <i>Puissance</i> [kW]	n ₂ Çıkış Devri Output Speeds <i>Vitesse de sortie</i> [r.p.m]	i Tahvil Ratio <i>Rapport de réduction</i>	M ₂ Çıkış Momenti Output Torque <i>Couple de sortie</i>	Tip Type <i>Typ</i>		 kg
Ø110	0,5	M8 (5m)	0,75	12	120,792	591	IRCM 73 / 80 M 4b		
	0,6	M8 (5m)	0,75	13	107,423	525	IRCM 73 / 80 M 4b		
	0,6	M8 (5m)	0,75	15	96,194	470	IRCM 73 / 80 M 4b		
	0,7	M8 (5m)	0,75	16	86,628	424	IRCM 73 / 80 M 4b		
	0,8	M8 (5m)	1,1	19	73,889	530	IRCM 73 / 90 S 4a		
	0,9	M8 (5m)	1,1	21	65,252	468	IRCM 73 / 90 S 4a		
	1,0	M8 (5m)	1,5	24	57,996	567	IRCM 73 / 90 L 4a		
	1,2	M8 (5m)	1,5	27	51,846	507	IRCM 73 / 90 L 4a		
	1,4	M8 (5m)	2,2	33	41,848	600	IRCM 73 / 100 L 4a		
	1,7	M8 (5m)	2,2	39	35,564	510	IRCM 73 / 100 L 4a		
	1,9	M8 (5m)	2,2	44	32,098	461	IRCM 73 / 100 L 4a		
	2,3	M8 (5m)	3	53	26,291	514	IRCM 73 / 100 L 4b		
2,5	M8 (5m)	3	59	23,834	466	IRCM 73 / 100 L 4b			
Ø120	0,6	M8 (5m)	0,75	12	120,792	591	IRCM 73 / 80 M 4b		
	0,6	M8 (5m)	0,75	13	107,423	525	IRCM 73 / 80 M 4b		
	0,7	M8 (5m)	1,1	15	96,194	690	IRCM 73 / 90 S 4a		
	0,8	M8 (5m)	1,1	16	86,628	621	IRCM 73 / 90 S 4a		
	0,9	M8 (5m)	1,1	19	73,889	530	IRCM 73 / 90 S 4a		
	1,0	M8 (5m)	1,1	21	65,252	468	IRCM 73 / 90 S 4a		
	1,1	M8 (5m)	1,5	24	57,996	567	IRCM 73 / 90 L 4a		
	1,3	M8 (5m)	1,5	27	51,846	507	IRCM 73 / 90 L 4a		
	1,6	M8 (5m)	2,2	33	41,848	600	IRCM 73 / 100 L 4a		
	1,8	M8 (5m)	2,2	39	35,564	510	IRCM 73 / 100 L 4a		
	2,1	M8 (5m)	3	44	32,098	628	IRCM 73 / 100 L 4b		
	2,5	M8 (5m)	3	53	26,291	514	IRCM 73 / 100 L 4b		
2,8	M8 (5m)	4	59	23,834	622	IRCM 73 / 112 M 4b			
Ø130	0,5	M8 (5m)	0,75	10	133,509	653	IRCM 83 / 80 M 4b		
	0,6	M8 (5m)	0,75	12	121,711	595	IRCM 83 / 80 M 4b		
	0,7	M8 (5m)	1,1	14	102,407	735	IRCM 83 / 90 S 4a		
	0,8	M8 (5m)	1,1	15	92,330	662	IRCM 83 / 90 S 4a		
	1,0	M8 (5m)	1,1	19	75,613	542	IRCM 83 / 90 S 4a		
	1,2	M8 (5m)	1,5	23	60,299	590	IRCM 83 / 90 L 4a		
	1,3	M8 (5m)	1,5	26	54,358	532	IRCM 83 / 90 L 4a		
	1,5	M8 (5m)	2,2	29	48,314	693	IRCM 83 / 100 L 4a		
	1,8	M8 (5m)	2,2	35	39,796	571	IRCM 83 / 100 L 4a		
	2,1	M8 (5m)	3	42	33,003	646	IRCM 83 / 100 L 4b		
	2,6	M8 (5m)	3	51	27,535	539	IRCM 83 / 100 L 4b		
	0,6	M8 (5m)	0,75	12	120,792	591	IRCM 73 / 80 M 4b		
	0,7	M8 (5m)	0,75	13	107,423	525	IRCM 73 / 80 M 4b		
	0,8	M8 (5m)	1,1	15	96,194	690	IRCM 73 / 90 S 4a		
	0,8	M8 (5m)	1,1	16	86,628	621	IRCM 73 / 90 S 4a		
	1,0	M8 (5m)	1,1	19	73,889	530	IRCM 73 / 90 S 4a		
	1,1	M8 (5m)	1,5	21	65,252	638	IRCM 73 / 90 L 4a		
	1,2	M8 (5m)	1,5	24	57,996	567	IRCM 73 / 90 L 4a		
	1,4	M8 (5m)	1,5	27	51,846	507	IRCM 73 / 90 L 4a		
	1,7	M8 (5m)	2,2	33	41,848	600	IRCM 73 / 100 L 4a		
	2,0	M8 (5m)	2,2	39	35,564	510	IRCM 73 / 100 L 4a		
	2,2	M7 (4m)	3	44	32,098	628	IRCM 73 / 100 L 4b		
	2,7	M7 (4m)	3	53	26,291	514	IRCM 73 / 100 L 4b		
	3,0	M7 (4m)	4	59	23,834	622	IRCM 73 / 112 M 4b		





D _T Tambur Çapı Drum Diameter <i>Diamètre de l'arbre</i> [mm]	V _h Kaldırma Hızı Lifting Speeds <i>Vitesse de levage</i> [m/min]	Vinç Sınıfı Crane Class <i>Classification de l'application de levage</i> ISO (FEM)	P ₁ Motor Gücü Power <i>Puissance</i> [kW]	n ₂ Çıkış Devri Output Speeds <i>Vitesse de sortie</i> [r.p.m]	i Tahvil Ratio <i>Rapport de réduction</i>	M ₂ Çıkış Momenti Output Torque <i>Couple de sortie</i>	Tip Type <i>Typ</i>		 kg
Ø140	0,5	M8 (5m)	0,75	10	133,509	653	IRCM 83 / 80 M 4b		
	0,7	M8 (5m)	0,75	12	121,711	595	IRCM 83 / 80 M 4b		
	0,8	M8 (5m)	1,1	14	102,407	735	IRCM 83 / 90 S 4a		
	0,8	M8 (5m)	1,1	15	92,330	662	IRCM 83 / 90 S 4a		
	1,0	M8 (5m)	1,5	19	75,613	740	IRCM 83 / 90 L 4a		
	1,3	M8 (5m)	1,5	23	60,299	590	IRCM 83 / 90 L 4a		
	1,4	M8 (5m)	2,2	26	54,358	780	IRCM 83 / 100 L 4a		
	1,6	M8 (5m)	2,2	29	48,314	693	IRCM 83 / 100 L 4a		
	1,9	M8 (5m)	2,2	35	39,796	571	IRCM 83 / 100 L 4a		
	2,3	M8 (5m)	3	42	33,003	646	IRCM 83 / 100 L 4b		
	2,8	M8 (5m)	4	51	27,535	718	IRCM 83 / 112 M 4b		
	0,7	M8 (5m)	0,75	12	120,792	591	IRCM 73 / 80 M 4b		
	0,7	M8 (5m)	1,1	13	107,423	771	IRCM 73 / 90 S 4a		
	0,8	M8 (5m)	1,1	15	96,194	690	IRCM 73 / 90 S 4a		
	0,9	M8 (5m)	1,1	16	86,628	621	IRCM 73 / 90 S 4a		
	1,0	M8 (5m)	1,5	19	73,889	723	IRCM 73 / 90 L 4a		
	1,2	M8 (5m)	1,5	21	65,252	638	IRCM 73 / 90 L 4a		
	1,3	M7 (4m)	1,5	24	57,996	567	IRCM 73 / 90 L 4a		
	1,5	M7 (4m)	2,2	27	51,846	744	IRCM 73 / 100 L 4a		
	1,8	M7 (4m)	2,2	33	41,848	600	IRCM 73 / 100 L 4a		
2,1	M7 (4m)	3	39	35,564	696	IRCM 73 / 100 L 4b			
2,4	M7 (4m)	3	44	32,098	628	IRCM 73 / 100 L 4b			
2,9	M7 (4m)	4	53	26,291	686	IRCM 73 / 112 M 4b			
3,2	M7 (4m)	4	59	23,834	622	IRCM 73 / 112 M 4b			
Ø150	0,6	M8 (5m)	0,75	10	133,509	653	IRCM 83 / 80 M 4b		
	0,7	M8 (5m)	1,1	12	121,711	873	IRCM 83 / 90 S 4a		
	0,8	M8 (5m)	1,1	14	102,407	735	IRCM 83 / 90 S 4a		
	0,9	M8 (5m)	1,1	15	92,330	662	IRCM 83 / 90 S 4a		
	1,1	M8 (5m)	1,5	19	75,613	740	IRCM 83 / 90 L 4a		
	1,4	M8 (5m)	1,5	23	60,299	590	IRCM 83 / 90 L 4a		
	1,5	M8 (5m)	2,2	26	54,358	780	IRCM 83 / 100 L 4a		
	1,7	M8 (5m)	2,2	29	48,314	693	IRCM 83 / 100 L 4a		
	2,1	M8 (5m)	3	35	39,796	779	IRCM 83 / 100 L 4b		
	2,5	M8 (5m)	3	42	33,003	646	IRCM 83 / 100 L 4b		
	3,0	M8 (5m)	4	51	27,535	718	IRCM 83 / 112 M 4b		
	0,7	M7 (4m)	1,1	12	120,792	866	IRCM 73 / 90 S 4a		
	0,8	M7 (4m)	1,1	13	107,423	771	IRCM 73 / 90 S 4a		
	0,9	M7 (4m)	1,1	15	96,194	690	IRCM 73 / 90 S 4a		
	0,9	M7 (4m)	1,1	16	86,628	621	IRCM 73 / 90 S 4a		
	1,1	M7 (4m)	1,5	19	73,889	723	IRCM 73 / 90 L 4a		
	1,2	M7 (4m)	1,5	21	65,252	638	IRCM 73 / 90 L 4a		
	1,4	M7 (4m)	2,2	24	57,996	832	IRCM 73 / 100 L 4a		
	1,6	M7 (4m)	2,2	27	51,846	744	IRCM 73 / 100 L 4a		
	1,9	M7 (4m)	2,2	33	41,848	600	IRCM 73 / 100 L 4a		
2,3	M7 (4m)	3	39	35,564	696	IRCM 73 / 100 L 4b			
2,6	M7 (4m)	3	44	32,098	628	IRCM 73 / 100 L 4b			
3,1	M7 (4m)	4	53	26,291	686	IRCM 73 / 112 M 4b			
3,5	M7 (4m)	4	59	23,834	622	IRCM 73 / 112 M 4b			



Vinç sistemleri kaldırma redüktörleri güç ve devir tabloları / Power and ratio table for hoisting applications / Tableau de classification des couples et rapports de réduction pour les applications de levage



D _T Tambur Çapı Drum Diameter Diamètre de l'arbre [mm]	V _h Kaldırma Hızı Lifting Speeds Vitesse de levage [m/min]	Vinç Sınıfı Crane Class Classification de l'application de levage ISO (FEM)	P ₁ Motor Gücü Power Puissance [kW]	n ₂ Çıkış Devri Output Speeds Vitesse de sortie [r.p.m]	i Tahvil Ratio Rapport de réduction	M ₂ Çıkış Momenti Output Torque Couple de sortie	Tip Type Typ		 kg
Ø160	0,6	M8 (5m)	0,75	10	133,509	653	IRCM 83 / 80 M 4b		
	0,8	M8 (5m)	1,1	12	121,711	873	IRCM 83 / 90 S 4a		
	0,9	M8 (5m)	1,1	14	102,407	735	IRCM 83 / 90 S 4a		
	0,9	M8 (5m)	1,1	15	92,330	662	IRCM 83 / 90 S 4a		
	1,2	M8 (5m)	1,5	19	75,613	740	IRCM 83 / 90 L 4a		
	1,4	M8 (5m)	2,2	23	60,299	865	IRCM 83 / 100 L 4a		
	1,6	M8 (5m)	2,2	26	54,358	780	IRCM 83 / 100 L 4a		
	1,8	M8 (5m)	2,2	29	48,314	693	IRCM 83 / 100 L 4a		
	2,2	M8 (5m)	3	35	39,796	779	IRCM 83 / 100 L 4b		
	2,6	M8 (5m)	3	42	33,003	646	IRCM 83 / 100 L 4b		
	3,2	M8 (5m)	4	51	27,535	718	IRCM 83 / 112 M 4b		
	0,8	M7 (4m)	1,1	12	120,792	866	IRCM 73 / 90 S 4a		
	0,8	M7 (4m)	1,1	13	107,423	771	IRCM 73 / 90 S 4a		
	0,9	M7 (4m)	1,1	15	96,194	690	IRCM 73 / 90 S 4a		
	1,0	M7 (4m)	1,1	16	86,628	621	IRCM 73 / 90 S 4a		
	1,2	M7 (4m)	1,5	19	73,889	723	IRCM 73 / 90 L 4a		
	1,3	M7 (4m)	1,5	21	65,252	638	IRCM 73 / 90 L 4a		
	1,5	M7 (4m)	2,2	24	57,996	832	IRCM 73 / 100 L 4a		
	1,7	M7 (4m)	2,2	27	51,846	744	IRCM 73 / 100 L 4a		
	2,1	M7 (4m)	3	33	41,848	819	IRCM 73 / 100 L 4b		
2,4	M7 (4m)	3	39	35,564	696	IRCM 73 / 100 L 4b			
2,8	M7 (4m)	3	44	32,098	628	IRCM 73 / 100 L 4b			
3,3	M7 (4m)	4	53	26,291	686	IRCM 73 / 112 M 4b			
3,7	M7 (4m)	5,5	59	23,834	855	IRCM 73 / 132 S 4c			
Ø170	0,7	M8 (5m)	0,75	10	133,509	653	IRCM 83 / 80 M 4b		
	0,8	M8 (5m)	1,1	12	121,711	873	IRCM 83 / 90 S 4a		
	0,9	M8 (5m)	1,1	14	102,407	735	IRCM 83 / 90 S 4a		
	1,0	M8 (5m)	1,1	15	92,330	662	IRCM 83 / 90 S 4a		
	1,3	M8 (5m)	1,5	19	75,613	740	IRCM 83 / 90 L 4a		
	1,5	M8 (5m)	2,2	23	60,299	865	IRCM 83 / 100 L 4a		
	1,7	M8 (5m)	2,2	26	54,358	780	IRCM 83 / 100 L 4a		
	1,9	M8 (5m)	2,2	29	48,314	693	IRCM 83 / 100 L 4a		
	2,3	M8 (5m)	3	35	39,796	779	IRCM 83 / 100 L 4b		
	2,8	M8 (5m)	4	42	33,003	861	IRCM 83 / 112 M 4b		
	3,4	M8 (5m)	4	51	27,535	718	IRCM 83 / 112 M 4b		
	0,8	M7 (4m)	1,1	12	120,792	866	IRCM 73 / 90 S 4a		
	0,9	M7 (4m)	1,1	13	107,423	771	IRCM 73 / 90 S 4a		
	1,0	M7 (4m)	1,1	15	96,194	690	IRCM 73 / 90 S 4a		
	1,1	M7 (4m)	1,5	16	86,628	847	IRCM 73 / 90 L 4a		
	1,3	M7 (4m)	1,5	19	73,889	723	IRCM 73 / 90 L 4a		
	1,4	M7 (4m)	2,2	21	65,252	936	IRCM 73 / 100 L 4a		
	1,6	M7 (4m)	2,2	24	57,996	832	IRCM 73 / 100 L 4a		
	1,8	M7 (4m)	2,2	27	51,846	744	IRCM 73 / 100 L 4a		
	2,2	M7 (4m)	3	33	41,848	819	IRCM 73 / 100 L 4b		
2,6	M7 (4m)	3	39	35,564	696	IRCM 73 / 100 L 4b			
2,9	M6 (3m)	4	44	32,098	837	IRCM 73 / 112 M 4b			
3,5	M6 (3m)	4	53	26,291	686	IRCM 73 / 112 M 4b			
3,9	M6 (3m)	5,5	59	23,834	855	IRCM 73 / 132 S 4c			





D _T Tambur Çapı Drum Diameter <i>Diamètre de l'arbre</i> [mm]	V _h Kaldırma Hızı Lifting Speeds <i>Vitesse de levage</i> [m/min]	Vinç Sınıfı Crane Class <i>Classification de l'application de levage</i> ISO (FEM)	P ₁ Motor Gücü Power <i>Puissance</i> [kW]	n ₂ Çıkış Devri Output Speeds <i>Vitesse de sortie</i> [r.p.m]	i Tahvil Ratio <i>Rapport de réduction</i>	M ₂ Çıkış Momenti Output Torque <i>Couple de sortie</i>	Tip Type <i>Typ</i>		 kg
Ø180	0,7	M8 (5m)	1,1	10	133,509	958	IRCM 83 / 90 S 4a		
	0,8	M8 (5m)	1,1	12	121,711	873	IRCM 83 / 90 S 4a		
	1,0	M8 (5m)	1,1	14	102,407	735	IRCM 83 / 90 S 4a		
	1,1	M8 (5m)	1,5	15	92,330	903	IRCM 83 / 90 L 4a		
	1,3	M8 (5m)	1,5	19	75,613	740	IRCM 83 / 90 L 4a		
	1,6	M8 (5m)	2,2	23	60,299	865	IRCM 83 / 100 L 4a		
	1,8	M8 (5m)	2,2	26	54,358	780	IRCM 83 / 100 L 4a		
	2,0	M8 (5m)	3	29	48,314	945	IRCM 83 / 100 L 4b		
	2,5	M8 (5m)	3	35	39,796	779	IRCM 83 / 100 L 4b		
	3,0	M8 (5m)	4	42	33,003	861	IRCM 83 / 112 M 4b		
	3,6	M8 (5m)	4	51	27,535	718	IRCM 83 / 112 M 4b		
	0,8	M7 (4m)	1,1	12	120,792	866	IRCM 73 / 90 S 4a		
	0,9	M7 (4m)	1,1	13	107,423	771	IRCM 73 / 90 S 4a		
	1,1	M7 (4m)	1,5	15	96,194	941	IRCM 73 / 90 L 4a		
	1,1	M6 (3m)	1,5	16	86,628	847	IRCM 73 / 90 L 4a		
	1,3	M6 (3m)	1,5	19	73,889	723	IRCM 73 / 90 L 4a		
	1,5	M6 (3m)	2,2	21	65,252	936	IRCM 73 / 100 L 4a		
	1,7	M6 (3m)	2,2	24	57,996	832	IRCM 73 / 100 L 4a		
	1,9	M6 (3m)	2,2	27	51,846	744	IRCM 73 / 100 L 4a		
	2,3	M6 (3m)	3	33	41,848	819	IRCM 73 / 100 L 4b		
2,8	M6 (3m)	3	39	35,564	696	IRCM 73 / 100 L 4b			
3,1	M6 (3m)	4	44	32,098	837	IRCM 73 / 112 M 4b			
Ø190	0,7	M8 (5m)	1,1	10	133,509	958	IRCM 83 / 90 S 4a		
	0,9	M8 (5m)	1,1	12	121,711	873	IRCM 83 / 90 S 4a		
	1,0	M8 (5m)	1,5	14	102,407	1002	IRCM 83 / 90 L 4a		
	1,1	M8 (5m)	1,5	15	92,330	903	IRCM 83 / 90 L 4a		
	1,4	M8 (5m)	2,2	19	75,613	1085	IRCM 83 / 100 L 4a		
	1,7	M8 (5m)	2,2	23	60,299	865	IRCM 83 / 100 L 4a		
	1,9	M8 (5m)	2,2	26	54,358	780	IRCM 83 / 100 L 4a		
	2,2	M8 (5m)	3	29	48,314	945	IRCM 83 / 100 L 4b		
	2,6	M8 (5m)	3	35	39,796	779	IRCM 83 / 100 L 4b		
	3,1	M8 (5m)	4	42	33,003	861	IRCM 83 / 112 M 4b		
3,8	M8 (5m)	5,5	51	27,535	988	IRCM 83 / 132 S 4c			
Ø200	0,8	M8 (5m)	1,1	10	133,509	958	IRCM 83 / 90 S 4a		
	0,9	M8 (5m)	1,1	12	121,711	873	IRCM 83 / 90 S 4a		
	1,1	M8 (5m)	1,5	14	102,407	1002	IRCM 83 / 90 L 4a		
	1,2	M8 (5m)	1,5	15	92,330	903	IRCM 83 / 90 L 4a		
	1,5	M8 (5m)	2,2	19	75,613	1085	IRCM 83 / 100 L 4a		
	1,8	M8 (5m)	2,2	23	60,299	865	IRCM 83 / 100 L 4a		
	2,0	M8 (5m)	3	26	54,358	1063	IRCM 83 / 100 L 4b		
	2,3	M8 (5m)	3	29	48,314	945	IRCM 83 / 100 L 4b		
	2,7	M8 (5m)	3	35	39,796	779	IRCM 83 / 100 L 4b		
	3,3	M8 (5m)	4	42	33,003	861	IRCM 83 / 112 M 4b		
4,0	M8 (5m)	5,5	51	27,535	988	IRCM 83 / 132 S 4c			



Vinç sistemleri kaldırma redüktörleri güç ve devir tabloları / Power and ratio table for hoisting applications / Tableau de classification des couples et rapports de réduction pour les applications de levage

D _T Tambur Çapı Drum Diameter <i>Diamètre de l'arbre</i> [mm]	V _h Kaldırma Hızı Lifting Speeds <i>Vitesse de levage</i> [m/min]	Vinç Sınıfı Crane Class <i>Classification de l'application de levage</i> ISO (FEM)	P ₁ Motor Gücü Power <i>Puissance</i> [kW]	n ₂ Çıkış Devri Output Speeds <i>Vitesse de sortie</i> [r.p.m]	i Tahvil Ratio <i>Rapport de réduction</i>	M ₂ Çıkış Momenti Output Torque <i>Couple de sortie</i>	Tip Type <i>Typ</i>		 kg
Ø280	3,1	M8 (5m)	5,5	7,1	198,333	7114	IRCM 123 / 132 S 4c		
	3,8	M8 (5m)	5,5	8,7	161,000	5775	IRCM 123 / 132 S 4c		
	4,4	M8 (5m)	7,5	10	134,473	6577	IRCM 123 / 132 M 4b		
	5,3	M8 (5m)	7,5	12	118,333	5788	IRCM 123 / 132 M 4b		
	5,7	M8 (5m)	9,2	13	105,000	6300	IRCM 123 / 132 M 4c		
	6,6	M8 (5m)	9,2	15	93,800	5628	IRCM 123 / 132 M 4c		
	7,5	M8 (5m)	11	17	84,259	6044	IRCM 123 / 160 M 4b		
	8,4	M8 (5m)	15	19	73,179	7158	IRCM 123 / 160 L 4a		
	9,7	M8 (5m)	15	22	64,396	6299	IRCM 123 / 160 L 4a		
	11	M8 (5m)	18,5	25	57,140	6894	IRCM 123 / 180 M 4b		
	12	M8 (5m)	18,5	27	51,045	6158	IRCM 123 / 180 M 4b		
	14	M8 (5m)	22	31	45,853	6578	IRCM 123 / 180 L 4b		
	3,1	M7 (4m)	5,5	7,0	199,476	7155	IRCM 103 / 132 S 4c		
	3,5	M7 (4m)	5,5	7,9	177,284	6359	IRCM 103 / 132 S 4c		
	4,3	M7 (4m)	7,5	10	143,552	7021	IRCM 103 / 132 M 4b		
	5,3	M7 (4m)	7,5	12	119,126	5826	IRCM 103 / 132 M 4b		
	5,7	M7 (4m)	9,2	13	109,276	6556	IRCM 103 / 132 M 4c		
	6,6	M7 (4m)	9,2	15	95,896	5753	IRCM 103 / 132 M 4c		
	7,9	M7 (4m)	11	18	78,692	5645	IRCM 103 / 160 M 4b		
	8,4	M7 (4m)	15	19	71,869	7030	IRCM 103 / 160 L 4a		
10,6	M7 (4m)	15	24	58,778	5750	IRCM 103 / 160 L 4a			
11,9	M7 (4m)	18,5	27	51,907	6262	IRCM 103 / 180 M 4b			
Ø290	3,2	M8 (5m)	5,5	7,1	198,333	7114	IRCM 123 / 132 S 4c		
	4,0	M8 (5m)	5,5	8,7	161,000	5775	IRCM 123 / 132 S 4c		
	4,6	M8 (5m)	7,5	10	134,473	6577	IRCM 123 / 132 M 4b		
	5,5	M8 (5m)	9,2	12	118,333	7099	IRCM 123 / 132 M 4c		
	5,9	M8 (5m)	9,2	13	105,000	6300	IRCM 123 / 132 M 4c		
	6,8	M8 (5m)	11	15	93,800	6729	IRCM 123 / 160 M 4b		
	7,7	M8 (5m)	11	17	84,259	6044	IRCM 123 / 160 M 4b		
	8,7	M8 (5m)	15	19	73,179	7158	IRCM 123 / 160 L 4a		
	10	M8 (5m)	15	22	64,396	6299	IRCM 123 / 160 L 4a		
	11	M8 (5m)	18,5	25	57,140	6894	IRCM 123 / 180 M 4b		
	12	M8 (5m)	18,5	27	51,045	6158	IRCM 123 / 180 M 4b		
	14	M8 (5m)	22	31	45,853	6578	IRCM 123 / 180 L 4b		
Ø300	3,3	M8 (5m)	5,5	7,1	198,333	7114	IRCM 123 / 132 S 4c		
	4,1	M8 (5m)	7,5	8,7	161,000	7874	IRCM 123 / 132 M 4b		
	4,7	M8 (5m)	7,5	10	134,473	6577	IRCM 123 / 132 M 4b		
	5,7	M8 (5m)	9,2	12	118,333	7099	IRCM 123 / 132 M 4c		
	6,1	M8 (5m)	9,2	13	105,000	6300	IRCM 123 / 132 M 4c		
	7,1	M8 (5m)	11	15	93,800	6729	IRCM 123 / 160 M 4b		
	8,0	M8 (5m)	15	17	84,259	8242	IRCM 123 / 160 L 4a		
	8,9	M8 (5m)	15	19	73,179	7158	IRCM 123 / 160 L 4a		
	10	M8 (5m)	15	22	64,396	6299	IRCM 123 / 160 L 4a		
	12	M8 (5m)	18,5	25	57,140	6894	IRCM 123 / 180 M 4b		
	13	M8 (5m)	18,5	27	51,045	6158	IRCM 123 / 180 M 4b		
	15	M8 (5m)	22	31	45,853	6578	IRCM 123 / 180 L 4b		
	3,3	M7 (4m)	5,5	7,0	199,476	7155	IRCM 103 / 132 S 4c		
	3,7	M7 (4m)	5,5	7,9	177,284	6359	IRCM 103 / 132 S 4c		
	4,6	M7 (4m)	7,5	10	143,552	7021	IRCM 103 / 132 M 4b		
	5,7	M7 (4m)	9,2	12	119,126	7147	IRCM 103 / 132 M 4c		
	6,1	M7 (4m)	9,2	13	109,276	6556	IRCM 103 / 132 M 4c		
	7,1	M7 (4m)	11	15	95,896	6879	IRCM 103 / 160 M 4b		
	8,5	M7 (4m)	15	18	78,692	7698	IRCM 103 / 160 L 4a		
	8,9	M7 (4m)	15	19	71,869	7030	IRCM 103 / 160 L 4a		
11,3	M7 (4m)	18,5	24	58,778	7091	IRCM 103 / 180 M 4b			
12,7	M7 (4m)	18,5	27	51,907	6262	IRCM 103 / 180 M 4b			





D _T Tambur Çapı Drum Diameter <i>Diamètre de l'arbre</i> [mm]	V _h Kaldırma Hızı Lifting Speeds <i>Vitesse de levage</i> [m/min]	Vinç Sınıfı Crane Class <i>Classification de l'application de levage</i> ISO (FEM)	P ₁ Motor Gücü Power <i>Puissance</i> [kW]	n ₂ Çıkış Devri Output Speeds <i>Vitesse de sortie</i> [r.p.m]	i Tahvil Ratio <i>Rapport de réduction</i>	M ₂ Çıkış Momenti Output Torque <i>Couple de sortie</i>	Tip Type <i>Typ</i>		 kg
Ø320	3,6	M8 (5m)	5,5	7,1	198,333	7114	IRCM 123 / 132 S 4c		
	4,4	M8 (5m)	7,5	8,7	161,000	7874	IRCM 123 / 132 M 4b		
	5,0	M8 (5m)	7,5	10	134,473	6577	IRCM 123 / 132 M 4b		
	6,0	M8 (5m)	9,2	12	118,333	7099	IRCM 123 / 132 M 4c		
	6,5	M8 (5m)	9,2	13	105,000	6300	IRCM 123 / 132 M 4c		
	7,5	M8 (5m)	11	15	93,800	6729	IRCM 123 / 160 M 4b		
	8,5	M8 (5m)	15	17	84,259	8242	IRCM 123 / 160 L 4a		
	9,5	M8 (5m)	15	19	73,179	7158	IRCM 123 / 160 L 4a		
	11	M8 (5m)	18,5	22	64,396	7769	IRCM 123 / 180 M 4b		
	13	M8 (5m)	18,5	25	57,140	6894	IRCM 123 / 180 M 4b		
	14	M8 (5m)	22	27	51,045	7323	IRCM 123 / 180 L 4b		
	16	M8 (5m)	22	31	45,853	6578	IRCM 123 / 180 L 4b		
	3,5	M7 (4m)	5,5	7,0	199,476	7155	IRCM 103 / 132 S 4c		
	4,0	M7 (4m)	5,5	7,9	177,284	6359	IRCM 103 / 132 S 4c		
	4,9	M7 (4m)	7,5	10	143,552	7021	IRCM 103 / 132 M 4b		
	6,0	M7 (4m)	9,2	12	119,126	7147	IRCM 103 / 132 M 4c		
	6,5	M7 (4m)	9,2	13	109,276	6556	IRCM 103 / 132 M 4c		
	7,5	M7 (4m)	11	15	95,896	6879	IRCM 103 / 160 M 4b		
	9,0	M7 (4m)	15	18	78,692	7698	IRCM 103 / 160 L 4a		
	9,5	M7 (4m)	15	19	71,869	7030	IRCM 103 / 160 L 4a		
12,1	M7 (4m)	18,5	24	58,778	7091	IRCM 103 / 180 M 4b			
13,6	M6 (3m)	22	27	51,907	7447	IRCM 103 / 180 L 4b			
Ø340	3,8	M8 (5m)	5,5	7,1	198,333	7114	IRCM 123 / 132 S 4c		
	4,6	M8 (5m)	7,5	8,7	161,000	7874	IRCM 123 / 132 M 4b		
	5,3	M8 (5m)	7,5	10	134,473	6577	IRCM 123 / 132 M 4b		
	6,4	M8 (5m)	9,2	12	118,333	7099	IRCM 123 / 132 M 4c		
	6,9	M8 (5m)	11	13	105,000	7532	IRCM 123 / 160 M 4b		
	8,0	M8 (5m)	15	15	93,800	9175	IRCM 123 / 160 L 4a		
	9,1	M8 (5m)	15	17	84,259	8242	IRCM 123 / 160 L 4a		
	10,1	M8 (5m)	15	19	73,179	7158	IRCM 123 / 160 L 4a		
	12	M8 (5m)	18,5	22	64,396	7769	IRCM 123 / 180 M 4b		
	13	M8 (5m)	18,5	25	57,140	6894	IRCM 123 / 180 M 4b		
	14	M8 (5m)	22	27	51,045	7323	IRCM 123 / 180 L 4b		
	17	M8 (5m)	30	31	45,853	8971	IRCM 123 / 200 L 4c		
	3,7	M7 (4m)	5,5	7,0	199,476	7155	IRCM 103 / 132 S 4c		
	4,2	M7 (4m)	7,5	7,9	177,284	8671	IRCM 103 / 132 M 4b		
	5,2	M7 (4m)	7,5	10	143,552	7021	IRCM 103 / 132 M 4b		
	6,4	M7 (4m)	9,2	12	119,126	7147	IRCM 103 / 132 M 4c		
	6,9	M7 (4m)	11	13	109,276	7839	IRCM 103 / 160 M 4b		
	8,0	M7 (4m)	15	15	95,896	9380	IRCM 103 / 160 L 4a		
	9,6	M7 (4m)	15	18	78,692	7698	IRCM 103 / 160 L 4a		
	10,1	M7 (4m)	15	19	71,869	7030	IRCM 103 / 160 L 4a		
12,8	M6 (3m)	18,5	24	58,778	7091	IRCM 103 / 180 M 4b			
14,4	M6 (3m)	22	27	51,907	7447	IRCM 103 / 180 L 4b			
Ø360	4,0	M8 (5m)	7,5	7,1	198,333	9700	IRCM 123 / 132 M 4b		
	4,9	M8 (5m)	7,5	8,7	161,000	7874	IRCM 123 / 132 M 4b		
	5,7	M8 (5m)	9,2	10	134,473	8068	IRCM 123 / 132 M 4c		
	6,8	M8 (5m)	11	12	118,333	8489	IRCM 123 / 160 M 4b		
	7,3	M8 (5m)	11	13	105,000	7532	IRCM 123 / 160 M 4b		
	8,5	M8 (5m)	15	15	93,800	9175	IRCM 123 / 160 L 4a		
	9,6	M8 (5m)	15	17	84,259	8242	IRCM 123 / 160 L 4a		
	10,7	M8 (5m)	15	19	73,179	7158	IRCM 123 / 160 L 4a		
	12	M8 (5m)	18,5	22	64,396	7769	IRCM 123 / 180 M 4b		
	14	M8 (5m)	22	25	57,140	8198	IRCM 123 / 180 L 4b		
	15	M8 (5m)	22	27	51,045	7323	IRCM 123 / 180 L 4b		
	18	M7 (4m)	30	31	45,853	8971	IRCM 123 / 200 L 4c		

Vinç sistemleri kaldırma redüktörleri güç ve devir tabloları / Power and ratio table for hoisting applications / Tableau de classification des couples et rapports de réduction pour les applications de levage



Vinç sistemleri kaldırma redüktörleri güç ve devir tabloları / Power and ratio table for hoisting applications / Tableau de classification des couples et rapports de réduction pour les applications de levage

D _T Tambur Çapı Drum Diameter Diamètre de l'arbre [mm]	V _h Kaldırma Hızı Lifting Speeds Vitesse de levage [m/min]	Vinç Sınıfı Crane Class Classification de l'application de levage ISO (FEM)	P ₁ Motor Gücü Power Puissance [kW]	n ₂ Çıkış Devri Output Speeds Vitesse de sortie [r.p.m]	i Tahvil Ratio Rapport de réduction	M ₂ Çıkış Momenti Output Torque Couple de sortie	Tip Type Typ		 kg	
Ø380	4,0	M6 (3m)	5,5	7,0	199,476	7155	IRCM 103 / 132 S 4c			
	4,5	M6 (3m)	7,5	7,9	177,284	8671	IRCM 103 / 132 M 4b			
	5,5	M6 (3m)	9,2	10	143,552	8613	IRCM 103 / 132 M 4c			
	6,8	M6 (3m)	11	12	119,126	8545	IRCM 103 / 160 M 4b			
	7,3	M6 (3m)	11	13	109,276	7839	IRCM 103 / 160 M 4b			
	8,5	M6 (3m)	15	15	95,896	9380	IRCM 103 / 160 L 4a			
	10,2	M6 (3m)	15	18	78,692	7698	IRCM 103 / 160 L 4a			
	10,7	M6 (3m)	15	19	71,869	7030	IRCM 103 / 160 L 4a			
	13,6	M6 (3m)	22	24	58,778	8433	IRCM 103 / 180 L 4b			
	15,3	M6 (3m)	22	27	51,907	7447	IRCM 103 / 180 L 4b			
Ø380	4,2	M8 (5m)	7,5	7,1	198,333	9700	IRCM 123 / 132 M 4b			
	5,2	M7 (4m)	7,5	8,7	161,000	7874	IRCM 123 / 132 M 4b			
	6,0	M7 (4m)	9,2	10	134,473	8068	IRCM 123 / 132 M 4c			
	7,2	M7 (4m)	11	12	118,333	8489	IRCM 123 / 160 M 4b			
	7,8	M7 (4m)	11	13	105,000	7532	IRCM 123 / 160 M 4b			
	8,9	M7 (4m)	15	15	93,800	9175	IRCM 123 / 160 L 4a			
	10,1	M7 (4m)	15	17	84,259	8242	IRCM 123 / 160 L 4a			
	11,3	M7 (4m)	18,5	19	73,179	8829	IRCM 123 / 180 M 4b			
	13	M7 (4m)	18,5	22	64,396	7769	IRCM 123 / 180 M 4b			
	15	M7 (4m)	22	25	57,140	8198	IRCM 123 / 180 L 4b			
Ø380	16	M7 (4m)	30	27	51,045	9986	IRCM 123 / 200 L 4c			
	18	M7 (4m)	30	31	45,853	8971	IRCM 123 / 200 L 4c			
	4,2	M6 (3m)	7,5	7,0	199,476	9756	IRCM 103 / 132 M 4b			
	4,7	M6 (3m)	7,5	7,9	177,284	8671	IRCM 103 / 132 M 4b			
	5,8	M6 (3m)	9,2	10	143,552	8613	IRCM 103 / 132 M 4c			
	7,2	M6 (3m)	11	12	119,126	8545	IRCM 103 / 160 M 4b			
	7,8	M6 (3m)	11	13	109,276	7839	IRCM 103 / 160 M 4b			
	8,9	M6 (3m)	15	15	95,896	9380	IRCM 103 / 160 L 4a			
	10,7	M6 (3m)	15	18	78,692	7698	IRCM 103 / 160 L 4a			
	11,3	M6 (3m)	18,5	19	71,869	8671	IRCM 103 / 180 M 4b			
Ø380	14,3	M6 (3m)	22	24	58,778	8433	IRCM 103 / 180 L 4b			
	16,1	M5 (2m)	30	27	51,907	10155	IRCM 103 / 200 L 4c			
	Ø400	4,5	M7 (4m)	7,5	7,1	198,333	9700	IRCM 123 / 132 M 4b		
		5,5	M7 (4m)	9,2	8,7	161,000	9659	IRCM 123 / 132 M 4c		
		6,3	M7 (4m)	9,2	10	134,473	8068	IRCM 123 / 132 M 4c		
		7,5	M7 (4m)	11	12	118,333	8489	IRCM 123 / 160 M 4b		
		8,2	M7 (4m)	15	13	105,000	10271	IRCM 123 / 160 L 4a		
		9,4	M7 (4m)	15	15	93,800	9175	IRCM 123 / 160 L 4a		
		10,7	M7 (4m)	15	17	84,259	8242	IRCM 123 / 160 L 4a		
		11,9	M7 (4m)	18,5	19	73,179	8829	IRCM 123 / 180 M 4b		
14		M7 (4m)	22	22	64,396	9239	IRCM 123 / 180 L 4b			
16		M7 (4m)	22	25	57,140	8198	IRCM 123 / 180 L 4b			
Ø400	17	M7 (4m)	30	27	51,045	9986	IRCM 123 / 200 L 4c			
	19	M7 (4m)	30	31	45,853	8971	IRCM 123 / 200 L 4c			
	4,4	M6 (3m)	7,5	7,0	199,476	9756	IRCM 103 / 132 M 4b			
	5,0	M6 (3m)	7,5	7,9	177,284	8671	IRCM 103 / 132 M 4b			
	6,2	M6 (3m)	9,2	10	143,552	8613	IRCM 103 / 132 M 4c			
	7,5	M6 (3m)	11	12	119,126	8545	IRCM 103 / 160 M 4b			
	8,2	M6 (3m)	15	13	109,276	10689	IRCM 103 / 160 L 4a			
	9,4	M6 (3m)	15	15	95,896	9380	IRCM 103 / 160 L 4a			
	11,3	M6 (3m)	18,5	18	78,692	9494	IRCM 103 / 180 M 4b			
	11,9	M6 (3m)	18,5	19	71,869	8671	IRCM 103 / 180 M 4b			
Ø400	15,1	M6 (3m)	22	24	58,778	8433	IRCM 103 / 180 L 4b			
	17,0	M5 (2m)	30	27	51,907	10155	IRCM 103 / 200 L 4c			





D _T Tambur Çapı Drum Diameter <i>Diamètre de l'arbre</i> [mm]	V _h Kaldırma Hızı Lifting Speeds <i>Vitesse de levage</i> [m/min]	Vinç Sınıfı Crane Class <i>Classification de l'application de levage</i> ISO (FEM)	P ₁ Motor Gücü Power <i>Puissance</i> [kW]	n ₂ Çıkış Devri Output Speeds <i>Vitesse de sortie</i> [r.p.m]	i Tahvil Ratio <i>Rapport de réduction</i>	M ₂ Çıkış Momenti Output Torque <i>Couple de sortie</i>	Tip Type <i>Typ</i>		 kg
Ø420	4,7	M7 (4m)	7,5	7,1	198,333	9700	IRCM 123 / 132 M 4b		
	5,7	M7 (4m)	9,2	8,7	161,000	9659	IRCM 123 / 132 M 4c		
	6,6	M7 (4m)	9,2	10	134,473	8068	IRCM 123 / 132 M 4c		
	7,9	M7 (4m)	11	12	118,333	8489	IRCM 123 / 160 M 4b		
	8,6	M7 (4m)	15	13	105,000	10271	IRCM 123 / 160 L 4a		
	9,9	M7 (4m)	15	15	93,800	9175	IRCM 123 / 160 L 4a		
	11,2	M7 (4m)	18,5	17	84,259	10165	IRCM 123 / 180 M 4b		
	12,5	M7 (4m)	18,5	19	73,179	8829	IRCM 123 / 180 M 4b		
	15	M7 (4m)	22	22	64,396	9239	IRCM 123 / 180 L 4b		
	16	M7 (4m)	30	25	57,140	11179	IRCM 123 / 200 L 4c		
	18	M7 (4m)	30	27	51,045	9986	IRCM 123 / 200 L 4c		
	20	M7 (4m)	30	31	45,853	8971	IRCM 123 / 200 L 4c		
	4,6	M6 (3m)	7,5	7,0	199,476	9756	IRCM 103 / 132 M 4b		
	5,2	M6 (3m)	7,5	7,9	177,284	8671	IRCM 103 / 132 M 4b		
	6,5	M6 (3m)	9,2	10	143,552	8613	IRCM 103 / 132 M 4c		
	7,9	M6 (3m)	11	12	119,126	8545	IRCM 103 / 160 M 4b		
	8,6	M6 (3m)	15	13	109,276	10689	IRCM 103 / 160 L 4a		
	9,9	M6 (3m)	15	15	95,896	9380	IRCM 103 / 160 L 4a		
	11,9	M6 (3m)	18,5	18	78,692	9494	IRCM 103 / 180 M 4b		
	12,5	M6 (3m)	18,5	19	71,869	8671	IRCM 103 / 180 M 4b		
15,8	M5 (2m)	22	24	58,778	8433	IRCM 103 / 180 L 4b			
17,8	M5 (2m)	30	27	51,907	10155	IRCM 103 / 200 L 4c			



Vinç sistemleri kaldırma redüktörleri güç ve devir tabloları / Power and ratio table for hoisting applications / Tableau de classification des couples et rapports de réduction pour les applications de levage



D _T Tambur Çapı Drum Diameter <i>Diamètre de l'arbre</i> [mm]	V _h Kaldırma Hızı Lifting Speeds <i>Vitesse de levage</i> [m/min]	Vinç Sınıfı Crane Class <i>Classification de l'application de levage</i> ISO (FEM)	P ₁ Motor Gücü Power <i>Puissance</i> [kW]	n ₂ Çıkış Devri Output Speeds <i>Vitesse de sortie</i> [r.p.m]	i Tahvil Ratio <i>Rapport de réduction</i>	M ₂ Çıkış Momenti Output Torque <i>Couple de sortie</i>	Tip Type <i>Typ</i>		 kg
Ø230	1,3	M8 (5m)	2,2	7,0	199,476	2862	IRCM 103 / 100 L 4a		
	1,4	M8 (5m)	2,2	7,9	177,284	2543	IRCM 103 / 100 L 4a		
	1,8	M8 (5m)	3	10	143,552	2808	IRCM 103 / 100 L 4b		
	2,2	M8 (5m)	3	12	119,126	2331	IRCM 103 / 100 L 4b		
	2,3	M8 (5m)	4	13	109,276	2850	IRCM 103 / 112 M 4b		
	2,7	M8 (5m)	4	15	95,896	2501	IRCM 103 / 112 M 4b		
	3,2	M8 (5m)	5,5	18	78,692	2822	IRCM 103 / 132 S 4c		
	3,4	M8 (5m)	5,5	19	71,869	2578	IRCM 103 / 132 S 4c		
	4,3	M8 (5m)	7,5	24	58,778	2875	IRCM 103 / 132 M 4b		
	4,9	M8 (5m)	7,5	27	51,907	2539	IRCM 103 / 132 M 4b		
	1,6	M8 (5m)	2,2	8,6	162,826	2336	IRCM 93 / 100 L 4a		
	1,7	M8 (5m)	3	9,5	146,946	2875	IRCM 93 / 100 L 4b		
	1,8	M8 (5m)	3	10	133,419	2610	IRCM 93 / 100 L 4b		
	2,3	M8 (5m)	4	13	111,602	2911	IRCM 93 / 112 M 4b		
	2,9	M8 (5m)	4	16	87,936	2294	IRCM 93 / 112 M 4b		
	3,2	M8 (5m)	5,5	18	79,841	2864	IRCM 93 / 132 S 4c		
	3,8	M7 (4m)	5,5	21	66,785	2395	IRCM 93 / 132 S 4c		
	4,2	M7 (4m)	7,5	23	61,444	3005	IRCM 93 / 132 M 4b		
	4,7	M7 (4m)	7,5	26	54,545	2668	IRCM 93 / 132 M 4b		
	5,6	M7 (4m)	9,2	31	44,753	2685	IRCM 93 / 132 M 4c		
6,9	M7 (4m)	11	38	37,199	2668	IRCM 93 / 160 M 4b			
7,4	M7 (4m)	11	41	34,034	2441	IRCM 93 / 160 M 4b			
8,1	M7 (4m)	15	45	31,194	3051	IRCM 93 / 160 L 4a			
Ø240	1,3	M8 (5m)	2,2	7,0	199,476	2862	IRCM 103 / 100 L 4a		
	1,5	M8 (5m)	2,2	7,9	177,284	2543	IRCM 103 / 100 L 4a		
	1,8	M8 (5m)	3	10	143,552	2808	IRCM 103 / 100 L 4b		
	2,3	M8 (5m)	4	12	119,126	3107	IRCM 103 / 112 M 4b		
	2,4	M8 (5m)	4	13	109,276	2850	IRCM 103 / 112 M 4b		
	2,8	M8 (5m)	4	15	95,896	2501	IRCM 103 / 112 M 4b		
	3,4	M8 (5m)	5,5	18	78,692	2822	IRCM 103 / 132 S 4c		
	3,6	M8 (5m)	5,5	19	71,869	2578	IRCM 103 / 132 S 4c		
	4,5	M8 (5m)	7,5	24	58,778	2875	IRCM 103 / 132 M 4b		
	5,1	M8 (5m)	7,5	27	51,907	2539	IRCM 103 / 132 M 4b		
	1,6	M8 (5m)	3	8,6	162,826	3186	IRCM 93 / 100 L 4b		
	1,8	M8 (5m)	3	9,5	146,946	2875	IRCM 93 / 100 L 4b		
	1,9	M8 (5m)	3	10	133,419	2610	IRCM 93 / 100 L 4b		
	2,4	M8 (5m)	4	13	111,602	2911	IRCM 93 / 112 M 4b		
	3,0	M8 (5m)	5,5	16	87,936	3154	IRCM 93 / 132 S 4c		
	3,4	M7 (4m)	5,5	18	79,841	2864	IRCM 93 / 132 S 4c		
	4,0	M7 (4m)	5,5	21	66,785	2395	IRCM 93 / 132 S 4c		
	4,3	M7 (4m)	7,5	23	61,444	3005	IRCM 93 / 132 M 4b		
	4,9	M7 (4m)	7,5	26	54,545	2668	IRCM 93 / 132 M 4b		
	5,8	M7 (4m)	9,2	31	44,753	2685	IRCM 93 / 132 M 4c		
7,2	M7 (4m)	11	38	37,199	2668	IRCM 93 / 160 M 4b			
7,7	M7 (4m)	11	41	34,034	2441	IRCM 93 / 160 M 4b			
8,5	M7 (4m)	15	45	31,194	3051	IRCM 93 / 160 L 4a			
	1,4	M8 (5m)	2,2	7,0	199,476	2862	IRCM 103 / 100 L 4a		
	1,6	M8 (5m)	2,2	7,9	177,284	2543	IRCM 103 / 100 L 4a		
	1,9	M8 (5m)	3	10	143,552	2808	IRCM 103 / 100 L 4b		
	2,4	M8 (5m)	4	12	119,126	3107	IRCM 103 / 112 M 4b		
	2,6	M8 (5m)	4	13	109,276	2850	IRCM 103 / 112 M 4b		
	2,9	M8 (5m)	5,5	15	95,896	3440	IRCM 103 / 132 S 4c		
	3,5	M8 (5m)	5,5	18	78,692	2822	IRCM 103 / 132 S 4c		
	3,7	M8 (5m)	5,5	19	71,869	2578	IRCM 103 / 132 S 4c		
	4,7	M8 (5m)	7,5	24	58,778	2875	IRCM 103 / 132 M 4b		
	5,3	M8 (5m)	7,5	27	51,907	2539	IRCM 103 / 132 M 4b		



D _T Tambur Çapı Drum Diameter <i>Diamètre de l'arbre</i> [mm]	V _h Kaldırma Hızı Lifting Speeds <i>Vitesse de levage</i> [m/min]	Vinç Sınıfı Crane Class <i>Classification de l'application de levage</i> ISO (FEM)	P ₁ Motor Gücü Power <i>Puissance</i> [kW]	n ₂ Çıkış Devri Output Speeds <i>Vitesse de sortie</i> [r.p.m]	i Tahvil Ratio <i>Rapport de réduction</i>	M ₂ Çıkış Momenti Output Torque <i>Couple de sortie</i>	Tip Type <i>Typ</i>		 kg
Ø250	1,7	M8 (5m)	3	8,6	162,826	3186	IRCM 93 / 100 L 4b		
	1,9	M8 (5m)	3	9,5	146,946	2875	IRCM 93 / 100 L 4b		
	2,0	M8 (5m)	3	10	133,419	2610	IRCM 93 / 100 L 4b		
	2,6	M8 (5m)	4	13	111,602	2911	IRCM 93 / 112 M 4b		
	3,1	M7 (4m)	5,5	16	87,936	3154	IRCM 93 / 132 S 4c		
	3,5	M7 (4m)	5,5	18	79,841	2864	IRCM 93 / 132 S 4c		
	4,1	M7 (4m)	7,5	21	66,785	3266	IRCM 93 / 132 M 4b		
	4,5	M7 (4m)	7,5	23	61,444	3005	IRCM 93 / 132 M 4b		
	5,1	M7 (4m)	7,5	26	54,545	2668	IRCM 93 / 132 M 4b		
	6,1	M7 (4m)	9,2	31	44,753	2685	IRCM 93 / 132 M 4c		
	7,5	M7 (4m)	11	38	37,199	2668	IRCM 93 / 160 M 4b		
	8,0	M7 (4m)	15	41	34,034	3329	IRCM 93 / 160 L 4a		
	8,8	M7 (4m)	15	45	31,194	3051	IRCM 93 / 160 L 4a		
Ø260	1,4	M8 (5m)	2,2	7,0	199,476	2862	IRCM 103 / 100 L 4a		
	1,6	M8 (5m)	3	7,9	177,284	3468	IRCM 103 / 100 L 4b		
	2,0	M8 (5m)	3	10	143,552	2808	IRCM 103 / 100 L 4b		
	2,4	M8 (5m)	4	12	119,126	3107	IRCM 103 / 112 M 4b		
	2,7	M8 (5m)	4	13	109,276	2850	IRCM 103 / 112 M 4b		
	3,1	M8 (5m)	5,5	15	95,896	3440	IRCM 103 / 132 S 4c		
	3,7	M8 (5m)	5,5	18	78,692	2822	IRCM 103 / 132 S 4c		
	3,9	M8 (5m)	5,5	19	71,869	2578	IRCM 103 / 132 S 4c		
	4,9	M8 (5m)	7,5	24	58,778	2875	IRCM 103 / 132 M 4b		
	5,5	M8 (5m)	9,2	27	51,907	3114	IRCM 103 / 132 M 4c		
	1,8	M8 (5m)	3	8,6	162,826	3186	IRCM 93 / 100 L 4b		
	1,9	M8 (5m)	3	9,5	146,946	2875	IRCM 93 / 100 L 4b		
	2,0	M8 (5m)	3	10	133,419	2610	IRCM 93 / 100 L 4b		
	2,7	M7 (4m)	4	13	111,602	2911	IRCM 93 / 112 M 4b		
	3,3	M7 (4m)	5,5	16	87,936	3154	IRCM 93 / 132 S 4c		
	3,7	M7 (4m)	5,5	18	79,841	2864	IRCM 93 / 132 S 4c		
	4,3	M7 (4m)	7,5	21	66,785	3266	IRCM 93 / 132 M 4b		
	4,7	M7 (4m)	7,5	23	61,444	3005	IRCM 93 / 132 M 4b		
	5,3	M7 (4m)	7,5	26	54,545	2668	IRCM 93 / 132 M 4b		
	6,3	M7 (4m)	9,2	31	44,753	2685	IRCM 93 / 132 M 4c		
7,8	M6 (3m)	11	38	37,199	2668	IRCM 93 / 160 M 4b			
8,4	M6 (3m)	15	41	34,034	3329	IRCM 93 / 160 L 4a			
9,2	M6 (3m)	15	45	31,194	3051	IRCM 93 / 160 L 4a			
	1,5	M8 (5m)	2,2	7,0	199,476	2862	IRCM 103 / 100 L 4a		
	1,7	M8 (5m)	3	7,9	177,284	3468	IRCM 103 / 100 L 4b		
	2,1	M8 (5m)	3	10	143,552	2808	IRCM 103 / 100 L 4b		
	2,5	M8 (5m)	4	12	119,126	3107	IRCM 103 / 112 M 4b		
	2,8	M8 (5m)	4	13	109,276	2850	IRCM 103 / 112 M 4b		
	3,2	M8 (5m)	5,5	15	95,896	3440	IRCM 103 / 132 S 4c		
	3,8	M8 (5m)	5,5	18	78,692	2822	IRCM 103 / 132 S 4c		
	4,0	M8 (5m)	7,5	19	71,869	3515	IRCM 103 / 132 M 4b		
	5,1	M8 (5m)	7,5	24	58,778	2875	IRCM 103 / 132 M 4b		
	5,7	M8 (5m)	9,2	27	51,907	3114	IRCM 103 / 132 M 4c		



Vinç sistemleri kaldırma redüktörleri güç ve devir tabloları / Power and ratio table for hoisting applications / Tableau de classification des couples et rapports de réduction pour les applications de levage



D _T Tambur Çapı Drum Diameter Diamètre de l'arbre [mm]	V _h Kaldırma Hızı Lifting Speeds Vitesse de levage [m/min]	Vinç Sınıfı Crane Class Classification de l'application de levage ISO (FEM)	P ₁ Motor Gücü Power Puissance [kW]	n ₂ Çıkış Devri Output Speeds Vitesse de sortie [r.p.m]	i Tahvil Ratio Rapport de réduction	M ₂ Çıkış Momenti Output Torque Couple de sortie	Tip Type Typ		 kg
Ø270	1,8	M7 (4m)	3	8,6	162,826	3186	IRCM 93 / 100 L 4b		
	2,0	M7 (4m)	3	9,5	146,946	2875	IRCM 93 / 100 L 4b		
	2,1	M7 (4m)	3	10	133,419	2610	IRCM 93 / 100 L 4b		
	2,8	M7 (4m)	4	13	111,602	2911	IRCM 93 / 112 M 4b		
	3,4	M7 (4m)	5,5	16	87,936	3154	IRCM 93 / 132 S 4c		
	3,8	M7 (4m)	5,5	18	79,841	2864	IRCM 93 / 132 S 4c		
	4,5	M7 (4m)	7,5	21	66,785	3266	IRCM 93 / 132 M 4b		
	4,9	M7 (4m)	7,5	23	61,444	3005	IRCM 93 / 132 M 4b		
	5,5	M7 (4m)	9,2	26	54,545	3272	IRCM 93 / 132 M 4c		
	6,6	M6 (3m)	9,2	31	44,753	2685	IRCM 93 / 132 M 4c		
	8,1	M6 (3m)	15	38	37,199	3639	IRCM 93 / 160 L 4a		
	8,7	M6 (3m)	15	41	34,034	3329	IRCM 93 / 160 L 4a		
	9,5	M6 (3m)	15	45	31,194	3051	IRCM 93 / 160 L 4a		
Ø280	1,5	M8 (5m)	2,2	7,0	199,476	2862	IRCM 103 / 100 L 4a		
	1,7	M8 (5m)	3	7,9	177,284	3468	IRCM 103 / 100 L 4b		
	2,2	M8 (5m)	3	10	143,552	2808	IRCM 103 / 100 L 4b		
	2,6	M8 (5m)	4	12	119,126	3107	IRCM 103 / 112 M 4b		
	2,9	M8 (5m)	4	13	109,276	2850	IRCM 103 / 112 M 4b		
	3,3	M8 (5m)	5,5	15	95,896	3440	IRCM 103 / 132 S 4c		
	4,0	M8 (5m)	5,5	18	78,692	2822	IRCM 103 / 132 S 4c		
	4,2	M8 (5m)	7,5	19	71,869	3515	IRCM 103 / 132 M 4b		
	5,3	M8 (5m)	7,5	24	58,778	2875	IRCM 103 / 132 M 4b		
	5,9	M8 (5m)	9,2	27	51,907	3114	IRCM 103 / 132 M 4c		
	1,9	M7 (4m)	3	8,6	162,826	3186	IRCM 93 / 100 L 4b		
	2,1	M7 (4m)	3	9,5	146,946	2875	IRCM 93 / 100 L 4b		
	2,2	M7 (4m)	4	10	133,419	3480	IRCM 93 / 112 M 4b		
	2,9	M7 (4m)	4	13	111,602	2911	IRCM 93 / 112 M 4b		
	3,5	M7 (4m)	5,5	16	87,936	3154	IRCM 93 / 132 S 4c		
	4,0	M7 (4m)	5,5	18	79,841	2864	IRCM 93 / 132 S 4c		
	4,6	M7 (4m)	7,5	21	66,785	3266	IRCM 93 / 132 M 4b		
	5,1	M7 (4m)	7,5	23	61,444	3005	IRCM 93 / 132 M 4b		
	5,7	M6 (3m)	9,2	26	54,545	3272	IRCM 93 / 132 M 4c		
	6,8	M6 (3m)	11	31	44,753	3210	IRCM 93 / 160 M 4b		
	8,4	M6 (3m)	15	38	37,199	3639	IRCM 93 / 160 L 4a		
9,0	M6 (3m)	15	41	34,034	3329	IRCM 93 / 160 L 4a			
9,9	M6 (3m)	15	45	31,194	3051	IRCM 93 / 160 L 4a			
1,6	M8 (5m)	2,2	7,0	199,476	2862	IRCM 103 / 100 L 4a			
1,8	M8 (5m)	3	7,9	177,284	3468	IRCM 103 / 100 L 4b			
2,2	M8 (5m)	4	10	143,552	3745	IRCM 103 / 112 M 4b			
2,7	M8 (5m)	4	12	119,126	3107	IRCM 103 / 112 M 4b			
3,0	M8 (5m)	5,5	13	109,276	3919	IRCM 103 / 132 S 4c			
3,4	M8 (5m)	5,5	15	95,896	3440	IRCM 103 / 132 S 4c			
4,1	M8 (5m)	7,5	18	78,692	3849	IRCM 103 / 132 M 4b			
4,3	M8 (5m)	7,5	19	71,869	3515	IRCM 103 / 132 M 4b			
5,5	M8 (5m)	9,2	24	58,778	3526	IRCM 103 / 132 M 4c			
6,1	M8 (5m)	9,2	27	51,907	3114	IRCM 103 / 132 M 4c			





D _T Tambur Çapı Drum Diameter <i>Diamètre de l'arbre</i> [mm]	V _h Kaldırma Hızı Lifting Speeds <i>Vitesse de levage</i> [m/min]	Vinç Sınıfı Crane Class <i>Classification de l'application de levage</i> ISO (FEM)	P ₁ Motor Gücü Power <i>Puissance</i> [kW]	n ₂ Çıkış Devri Output Speeds <i>Vitesse de sortie</i> [r.p.m]	i Tahvil Ratio <i>Rapport de réduction</i>	M ₂ Çıkış Momenti Output Torque <i>Couple de sortie</i>	Tip Type <i>Typ</i>		 kg
Ø290	2,0	M7 (4m)	3	8,6	162,826	3186	IRCM 93 / 100 L 4b		
	2,2	M7 (4m)	3	9,5	146,946	2875	IRCM 93 / 100 L 4b		
	2,3	M7 (4m)	4	10	133,419	3480	IRCM 93 / 112 M 4b		
	3,0	M7 (4m)	5,5	13	111,602	4003	IRCM 93 / 132 S 4c		
	3,6	M7 (4m)	5,5	16	87,936	3154	IRCM 93 / 132 S 4c		
	4,1	M7 (4m)	7,5	18	79,841	3905	IRCM 93 / 132 M 4b		
	4,8	M6 (3m)	7,5	21	66,785	3266	IRCM 93 / 132 M 4b		
	5,2	M6 (3m)	7,5	23	61,444	3005	IRCM 93 / 132 M 4b		
	5,9	M6 (3m)	9,2	26	54,545	3272	IRCM 93 / 132 M 4c		
	7,1	M6 (3m)	11	31	44,753	3210	IRCM 93 / 160 M 4b		
	8,7	M6 (3m)	15	38	37,199	3639	IRCM 93 / 160 L 4a		
	9,3	M6 (3m)	15	41	34,034	3329	IRCM 93 / 160 L 4a		
	10	M6 (3m)	15	45	31,194	3051	IRCM 93 / 160 L 4a		
Ø300	1,6	M8 (5m)	3	7,0	199,476	3903	IRCM 103 / 100 L 4b		
	1,9	M8 (5m)	3	7,9	177,284	3468	IRCM 103 / 100 L 4b		
	2,3	M8 (5m)	4	10	143,552	3745	IRCM 103 / 112 M 4b		
	2,8	M8 (5m)	4	12	119,126	3107	IRCM 103 / 112 M 4b		
	3,1	M8 (5m)	5,5	13	109,276	3919	IRCM 103 / 132 S 4c		
	3,5	M8 (5m)	5,5	15	95,896	3440	IRCM 103 / 132 S 4c		
	4,2	M8 (5m)	7,5	18	78,692	3849	IRCM 103 / 132 M 4b		
	4,5	M8 (5m)	7,5	19	71,869	3515	IRCM 103 / 132 M 4b		
	5,7	M8 (5m)	9,2	24	58,778	3526	IRCM 103 / 132 M 4c		
	6,4	M8 (5m)	9,2	27	51,907	3114	IRCM 103 / 132 M 4c		
	2,0	M7 (4m)	3	8,6	162,826	3186	IRCM 93 / 100 L 4b		
	2,2	M7 (4m)	4	9,5	146,946	3833	IRCM 93 / 112 M 4b		
	2,4	M7 (4m)	4	10	133,419	3480	IRCM 93 / 112 M 4b		
	3,1	M7 (4m)	5,5	13	111,602	4003	IRCM 93 / 132 S 4c		
	3,8	M7 (4m)	5,5	16	87,936	3154	IRCM 93 / 132 S 4c		
	4,2	M6 (3m)	7,5	18	79,841	3905	IRCM 93 / 132 M 4b		
	4,9	M6 (3m)	7,5	21	66,785	3266	IRCM 93 / 132 M 4b		
	5,4	M6 (3m)	7,5	23	61,444	3005	IRCM 93 / 132 M 4b		
	6,1	M6 (3m)	9,2	26	54,545	3272	IRCM 93 / 132 M 4c		
	7,3	M6 (3m)	11	31	44,753	3210	IRCM 93 / 160 M 4b		
	8,9	M6 (3m)	15	38	37,199	3639	IRCM 93 / 160 L 4a		
	9,7	M6 (3m)	15	41	34,034	3329	IRCM 93 / 160 L 4a		
	11	M6 (3m)	15	45	31,194	3051	IRCM 93 / 160 L 4a		



Vinç sistemleri kaldırma redüktörleri güç ve devir tabloları / Power and ratio table for hoisting applications / Tableau de classification des couples et rapports de réduction pour les applications de levage



D _T Tambur Çapı Drum Diameter Diamètre de l'arbre [mm]	V _h Kaldırma Hızı Lifting Speeds Vitesse de levage [m/min]	Vinç Sınıfı Crane Class Classification de l'application de levage ISO (FEM)	P ₁ Motor Gücü Power Puissance [kW]	n ₂ Çıkış Devri Output Speeds Vitesse de sortie [r.p.m]	i Tahvil Ratio Rapport de réduction	M ₂ Çıkış Momenti Output Torque Couple de sortie	Tip Type Typ		 kg
Ø170	0,8	M8 (5m)	1,1	8,6	162,826	1168	IRCM 93 / 90 S 4a		
	0,8	M8 (5m)	1,5	9,5	146,946	1437	IRCM 93 / 90 L 4a		
	0,9	M8 (5m)	1,5	10	133,419	1305	IRCM 93 / 90 L 4a		
	1,2	M8 (5m)	2,2	13	111,602	1601	IRCM 93 / 100 L 4a		
	1,4	M8 (5m)	2,2	16	87,936	1262	IRCM 93 / 100 L 4a		
	1,6	M8 (5m)	3	18	79,841	1562	IRCM 93 / 100 L 4b		
	1,9	M8 (5m)	3	21	66,785	1307	IRCM 93 / 100 L 4b		
	2,0	M8 (5m)	3	23	61,444	1202	IRCM 93 / 100 L 4b		
	2,3	M8 (5m)	4	26	54,545	1423	IRCM 93 / 112 M 4b		
	2,8	M8 (5m)	4	31	44,753	1167	IRCM 93 / 112 M 4b		
	3,4	M8 (5m)	5,5	38	37,199	1334	IRCM 93 / 132 S 4c		
	3,6	M8 (5m)	5,5	41	34,034	1221	IRCM 93 / 132 S 4c		
	4,0	M8 (5m)	7,5	45	31,194	1526	IRCM 93 / 132 M 4b		
	0,9	M7 (4m)	1,5	10	133,509	1306	IRCM 83 / 90 L 4a		
	1,1	M7 (4m)	1,5	12	121,711	1191	IRCM 83 / 90 L 4a		
	1,2	M7 (4m)	2,2	14	102,407	1469	IRCM 83 / 100 L 4a		
	1,3	M7 (4m)	2,2	15	92,330	1325	IRCM 83 / 100 L 4a		
	1,7	M7 (4m)	3	19	75,613	1479	IRCM 83 / 100 L 4b		
	2,0	M7 (4m)	3	23	60,299	1180	IRCM 83 / 100 L 4b		
	2,3	M7 (4m)	4	26	54,358	1418	IRCM 83 / 112 M 4b		
2,6	M7 (4m)	4	29	48,314	1260	IRCM 83 / 112 M 4b			
3,1	M7 (4m)	5,5	35	39,796	1427	IRCM 83 / 132 S 4c			
3,7	M7 (4m)	5,5	42	33,003	1184	IRCM 83 / 132 S 4c			
4,5	M7 (4m)	7,5	51	27,535	1347	IRCM 83 / 132 M 4b			
Ø180	0,8	M8 (5m)	1,5	8,6	162,826	1593	IRCM 93 / 90 L 4a		
	0,9	M8 (5m)	1,5	9,5	146,946	1437	IRCM 93 / 90 L 4a		
	0,9	M8 (5m)	1,5	10	133,419	1305	IRCM 93 / 90 L 4a		
	1,2	M8 (5m)	2,2	13	111,602	1601	IRCM 93 / 100 L 4a		
	1,5	M8 (5m)	2,2	16	87,936	1262	IRCM 93 / 100 L 4a		
	1,7	M8 (5m)	3	18	79,841	1562	IRCM 93 / 100 L 4b		
	2,0	M8 (5m)	3	21	66,785	1307	IRCM 93 / 100 L 4b		
	2,2	M8 (5m)	3	23	61,444	1202	IRCM 93 / 100 L 4b		
	2,4	M8 (5m)	4	26	54,545	1423	IRCM 93 / 112 M 4b		
	2,9	M8 (5m)	5,5	31	44,753	1605	IRCM 93 / 132 S 4c		
	3,6	M8 (5m)	5,5	38	37,199	1334	IRCM 93 / 132 S 4c		
	3,9	M8 (5m)	5,5	41	34,034	1221	IRCM 93 / 132 S 4c		
	4,2	M8 (5m)	7,5	45	31,194	1526	IRCM 93 / 132 M 4b		
	0,9	M7 (4m)	1,5	10	133,509	1306	IRCM 83 / 90 L 4a		
	1,1	M7 (4m)	2,2	12	121,711	1746	IRCM 83 / 100 L 4a		
	1,3	M7 (4m)	2,2	14	102,407	1469	IRCM 83 / 100 L 4a		
	1,4	M7 (4m)	2,2	15	92,330	1325	IRCM 83 / 100 L 4a		
	1,8	M7 (4m)	3	19	75,613	1479	IRCM 83 / 100 L 4b		
	2,2	M7 (4m)	3	23	60,299	1180	IRCM 83 / 100 L 4b		
	2,4	M7 (4m)	4	26	54,358	1418	IRCM 83 / 112 M 4b		
2,7	M7 (4m)	4	29	48,314	1260	IRCM 83 / 112 M 4b			
3,3	M7 (4m)	5,5	35	39,796	1427	IRCM 83 / 132 S 4c			
4,0	M6 (3m)	5,5	42	33,003	1184	IRCM 83 / 132 S 4c			
4,8	M6 (3m)	7,5	51	27,535	1347	IRCM 83 / 132 M 4b			



D _T Tambur Çapı Drum Diameter <i>Diamètre de l'arbre</i> [mm]	V _h Kaldırma Hızı Lifting Speeds <i>Vitesse de levage</i> [m/min]	Vinç Sınıfı Crane Class <i>Classification de l'application de levage</i> ISO (FEM)	P ₁ Motor Gücü Power <i>Puissance</i> [kW]	n ₂ Çıkış Devri Output Speeds <i>Vitesse de sortie</i> [r.p.m]	i Tahvil Ratio <i>Rapport de réduction</i>	M ₂ Çıkış Momenti Output Torque <i>Couple de sortie</i>	Tip Type <i>Typ</i>		 kg
Ø190	0,9	M8 (5m)	1,5	8,6	162,826	1593	IRCM 93 / 90 L 4a		
	0,9	M8 (5m)	1,5	9,5	146,946	1437	IRCM 93 / 90 L 4a		
	1,0	M8 (5m)	1,5	10	133,419	1305	IRCM 93 / 90 L 4a		
	1,3	M8 (5m)	2,2	13	111,602	1601	IRCM 93 / 100 L 4a		
	1,6	M8 (5m)	2,2	16	87,936	1262	IRCM 93 / 100 L 4a		
	1,8	M8 (5m)	3	18	79,841	1562	IRCM 93 / 100 L 4b		
	2,1	M8 (5m)	3	21	66,785	1307	IRCM 93 / 100 L 4b		
	2,3	M8 (5m)	4	23	61,444	1603	IRCM 93 / 112 M 4b		
	2,6	M8 (5m)	4	26	54,545	1423	IRCM 93 / 112 M 4b		
	3,1	M8 (5m)	5,5	31	44,753	1605	IRCM 93 / 132 S 4c		
	3,8	M8 (5m)	5,5	38	37,199	1334	IRCM 93 / 132 S 4c		
	4,1	M8 (5m)	7,5	41	34,034	1665	IRCM 93 / 132 M 4b		
	4,5	M8 (5m)	7,5	45	31,194	1526	IRCM 93 / 132 M 4b		
	1,0	M7 (4m)	1,5	10	133,509	1306	IRCM 83 / 90 L 4a		
	1,2	M7 (4m)	2,2	12	121,711	1746	IRCM 83 / 100 L 4a		
	1,4	M7 (4m)	2,2	14	102,407	1469	IRCM 83 / 100 L 4a		
	1,5	M7 (4m)	2,2	15	92,330	1325	IRCM 83 / 100 L 4a		
	1,9	M7 (4m)	3	19	75,613	1479	IRCM 83 / 100 L 4b		
	2,3	M7 (4m)	4	23	60,299	1573	IRCM 83 / 112 M 4b		
	2,6	M7 (4m)	4	26	54,358	1418	IRCM 83 / 112 M 4b		
2,9	M7 (4m)	4	29	48,314	1260	IRCM 83 / 112 M 4b			
3,5	M6 (3m)	5,5	35	39,796	1427	IRCM 83 / 132 S 4c			
4,2	M6 (3m)	7,5	42	33,003	1614	IRCM 83 / 132 M 4b			
5,1	M6 (3m)	7,5	51	27,535	1347	IRCM 83 / 132 M 4b			
Ø200	0,9	M8 (5m)	1,5	8,6	162,826	1593	IRCM 93 / 90 L 4a		
	1,0	M8 (5m)	1,5	9,5	146,946	1437	IRCM 93 / 90 L 4a		
	1,0	M8 (5m)	1,5	10	133,419	1305	IRCM 93 / 90 L 4a		
	1,4	M8 (5m)	2,2	13	111,602	1601	IRCM 93 / 100 L 4a		
	1,7	M8 (5m)	3	16	87,936	1720	IRCM 93 / 100 L 4b		
	1,9	M8 (5m)	3	18	79,841	1562	IRCM 93 / 100 L 4b		
	2,2	M8 (5m)	4	21	66,785	1742	IRCM 93 / 112 M 4b		
	2,4	M8 (5m)	4	23	61,444	1603	IRCM 93 / 112 M 4b		
	2,7	M8 (5m)	4	26	54,545	1423	IRCM 93 / 112 M 4b		
	3,2	M8 (5m)	5,5	31	44,753	1605	IRCM 93 / 132 S 4c		
	4,0	M8 (5m)	5,5	38	37,199	1334	IRCM 93 / 132 S 4c		
	4,3	M8 (5m)	7,5	41	34,034	1665	IRCM 93 / 132 M 4b		
	4,7	M8 (5m)	7,5	45	31,194	1526	IRCM 93 / 132 M 4b		
	1,0	M7 (4m)	1,5	10	133,509	1306	IRCM 83 / 90 L 4a		
	1,3	M7 (4m)	2,2	12	121,711	1746	IRCM 83 / 100 L 4a		
	1,5	M7 (4m)	2,2	14	102,407	1469	IRCM 83 / 100 L 4a		
	1,6	M7 (4m)	2,2	15	92,330	1325	IRCM 83 / 100 L 4a		
	2,0	M7 (4m)	3	19	75,613	1479	IRCM 83 / 100 L 4b		
	2,4	M7 (4m)	4	23	60,299	1573	IRCM 83 / 112 M 4b		
	2,7	M6 (3m)	4	26	54,358	1418	IRCM 83 / 112 M 4b		
3,0	M6 (3m)	5,5	29	48,314	1733	IRCM 83 / 132 S 4c			
3,7	M6 (3m)	5,5	35	39,796	1427	IRCM 83 / 132 S 4c			
4,4	M6 (3m)	7,5	42	33,003	1614	IRCM 83 / 132 M 4b			
5,3	M6 (3m)	7,5	51	27,535	1347	IRCM 83 / 132 M 4b			



Vinç sistemleri kaldırma redüktörleri güç ve devir tabloları / Power and ratio table for hoisting applications / Tableau de classification des couples et rapports de réduction pour les applications de levage



D _T Tambur Çapı Drum Diameter Diamètre de l'arbre [mm]	V _h Kaldırma Hızı Lifting Speeds Vitesse de levage [m/min]	Vinç Sınıfı Crane Class Classification de l'application de levage ISO (FEM)	P ₁ Motor Gücü Power Puissance [kW]	n ₂ Çıkış Devri Output Speeds Vitesse de sortie [r.p.m]	i Tahvil Ratio Rapport de réduction	M ₂ Çıkış Momenti Output Torque Couple de sortie	Tip Type Typ		 kg
Ø210	0,9	M8 (5m)	1,5	8,6	162,826	1593	IRCM 93 / 90 L 4a		
	1,0	M8 (5m)	1,5	9,5	146,946	1437	IRCM 93 / 90 L 4a		
	1,1	M8 (5m)	2,2	10	133,419	1914	IRCM 93 / 100 L 4a		
	1,4	M8 (5m)	2,2	13	111,602	1601	IRCM 93 / 100 L 4a		
	1,8	M8 (5m)	3	16	87,936	1720	IRCM 93 / 100 L 4b		
	2,0	M8 (5m)	3	18	79,841	1562	IRCM 93 / 100 L 4b		
	2,3	M8 (5m)	4	21	66,785	1742	IRCM 93 / 112 M 4b		
	2,5	M8 (5m)	4	23	61,444	1603	IRCM 93 / 112 M 4b		
	2,9	M8 (5m)	4	26	54,545	1423	IRCM 93 / 112 M 4b		
	3,4	M8 (5m)	5,5	31	44,753	1605	IRCM 93 / 132 S 4c		
	4,2	M8 (5m)	7,5	38	37,199	1819	IRCM 93 / 132 M 4b		
	4,5	M8 (5m)	7,5	41	34,034	1665	IRCM 93 / 132 M 4b		
	4,9	M8 (5m)	7,5	45	31,194	1526	IRCM 93 / 132 M 4b		
	1,1	M6 (3m)	2,2	10	133,509	1915	IRCM 83 / 100 L 4a		
	1,3	M6 (3m)	2,2	12	121,711	1746	IRCM 83 / 100 L 4a		
	1,5	M6 (3m)	2,2	14	102,407	1469	IRCM 83 / 100 L 4a		
	1,6	M6 (3m)	3	15	92,330	1806	IRCM 83 / 100 L 4b		
	2,1	M6 (3m)	3	19	75,613	1479	IRCM 83 / 100 L 4b		
	2,5	M6 (3m)	4	23	60,299	1573	IRCM 83 / 112 M 4b		
	2,9	M6 (3m)	4	26	54,358	1418	IRCM 83 / 112 M 4b		
3,2	M6 (3m)	5,5	29	48,314	1733	IRCM 83 / 132 S 4c			
3,8	M6 (3m)	5,5	35	39,796	1427	IRCM 83 / 132 S 4c			
4,6	M6 (3m)	7,5	42	33,003	1614	IRCM 83 / 132 M 4b			
5,6	M6 (3m)	9,2	51	27,535	1652	IRCM 83 / 132 M 4c			
Ø220	1,0	M8 (5m)	1,5	8,6	162,826	1593	IRCM 93 / 90 L 4a		
	1,1	M8 (5m)	2,2	9,5	146,946	2108	IRCM 93 / 100 L 4a		
	1,2	M8 (5m)	2,2	10	133,419	1914	IRCM 93 / 100 L 4a		
	1,5	M8 (5m)	2,2	13	111,602	1601	IRCM 93 / 100 L 4a		
	1,8	M8 (5m)	3	16	87,936	1720	IRCM 93 / 100 L 4b		
	2,1	M8 (5m)	3	18	79,841	1562	IRCM 93 / 100 L 4b		
	2,4	M8 (5m)	4	21	66,785	1742	IRCM 93 / 112 M 4b		
	2,6	M8 (5m)	4	23	61,444	1603	IRCM 93 / 112 M 4b		
	3,0	M8 (5m)	5,5	26	54,545	1956	IRCM 93 / 132 S 4c		
	3,6	M8 (5m)	5,5	31	44,753	1605	IRCM 93 / 132 S 4c		
	4,4	M8 (5m)	7,5	38	37,199	1819	IRCM 93 / 132 M 4b		
	4,7	M8 (5m)	7,5	41	34,034	1665	IRCM 93 / 132 M 4b		
	5,2	M8 (5m)	7,5	45	31,194	1526	IRCM 93 / 132 M 4b		
	1,2	M6 (3m)	2,2	10	133,509	1915	IRCM 83 / 100 L 4a		
	1,4	M6 (3m)	2,2	12	121,711	1746	IRCM 83 / 100 L 4a		
	1,6	M6 (3m)	3	14	102,407	2003	IRCM 83 / 100 L 4b		
	1,7	M6 (3m)	3	15	92,330	1806	IRCM 83 / 100 L 4b		
	2,2	M6 (3m)	4	19	75,613	1972	IRCM 83 / 112 M 4b		
	2,6	M6 (3m)	4	23	60,299	1573	IRCM 83 / 112 M 4b		
	3,0	M6 (3m)	5,5	26	54,358	1950	IRCM 83 / 132 S 4c		
3,3	M6 (3m)	5,5	29	48,314	1733	IRCM 83 / 132 S 4c			
4,0	M6 (3m)	7,5	35	39,796	1946	IRCM 83 / 132 M 4b			
4,8	M5 (2m)	7,5	42	33,003	1614	IRCM 83 / 132 M 4b			
5,9	M5 (2m)	9,2	51	27,535	1652	IRCM 83 / 132 M 4c			



D _T Tambur Çapı Drum Diameter <i>Diamètre de l'arbre</i> [mm]	V _h Kaldırma Hızı Lifting Speeds <i>Vitesse de levage</i> [m/min]	Vinç Sınıfı Crane Class <i>Classification de l'application de levage</i> ISO (FEM)	P ₁ Motor Gücü Power <i>Puissance</i> [kW]	n ₂ Çıkış Devri Output Speeds <i>Vitesse de sortie</i> [r.p.m]	i Tahvil Ratio <i>Rapport de réduction</i>	M ₂ Çıkış Momenti Output Torque <i>Couple de sortie</i>	Tip Type <i>Typ</i>		 kg
Ø230	1,0	M8 (5m)	1,5	8,6	162,826	1593	IRCM 93 / 90 L 4a		
	1,1	M8 (5m)	2,2	9,5	146,946	2108	IRCM 93 / 100 L 4a		
	1,2	M8 (5m)	2,2	10	133,419	1914	IRCM 93 / 100 L 4a		
	1,6	M8 (5m)	2,2	13	111,602	1601	IRCM 93 / 100 L 4a		
	1,9	M8 (5m)	3	16	87,936	1720	IRCM 93 / 100 L 4b		
	2,2	M8 (5m)	3	18	79,841	1562	IRCM 93 / 100 L 4b		
	2,5	M8 (5m)	4	21	66,785	1742	IRCM 93 / 112 M 4b		
	2,8	M8 (5m)	4	23	61,444	1603	IRCM 93 / 112 M 4b		
	3,1	M8 (5m)	5,5	26	54,545	1956	IRCM 93 / 132 S 4c		
	3,7	M8 (5m)	5,5	31	44,753	1605	IRCM 93 / 132 S 4c		
	4,6	M8 (5m)	7,5	38	37,199	1819	IRCM 93 / 132 M 4b		
	4,9	M8 (5m)	7,5	41	34,034	1665	IRCM 93 / 132 M 4b		
	5,4	M8 (5m)	7,5	45	31,194	1526	IRCM 93 / 132 M 4b		
	1,2	M6 (3m)	2,2	10	133,509	1915	IRCM 83 / 100 L 4a		
	1,4	M6 (3m)	2,2	12	121,711	1746	IRCM 83 / 100 L 4a		
	1,7	M6 (3m)	3	14	102,407	2003	IRCM 83 / 100 L 4b		
	1,8	M6 (3m)	3	15	92,330	1806	IRCM 83 / 100 L 4b		
	2,3	M6 (3m)	4	19	75,613	1972	IRCM 83 / 112 M 4b		
	2,8	M6 (3m)	4	23	60,299	1573	IRCM 83 / 112 M 4b		
	3,1	M6 (3m)	5,5	26	54,358	1950	IRCM 83 / 132 S 4c		
	3,5	M6 (3m)	5,5	29	48,314	1733	IRCM 83 / 132 S 4c		
	4,2	M5 (2m)	7,5	35	39,796	1946	IRCM 83 / 132 M 4b		
5,1	M5 (2m)	7,5	42	33,003	1614	IRCM 83 / 132 M 4b			
6,1	M5 (2m)	9,2	51	27,535	1652	IRCM 83 / 132 M 4c			
Ø240	1,1	M8 (5m)	1,5	8,6	162,826	1593	IRCM 93 / 90 L 4a		
	1,2	M8 (5m)	2,2	9,5	146,946	2108	IRCM 93 / 100 L 4a		
	1,3	M8 (5m)	2,2	10	133,419	1914	IRCM 93 / 100 L 4a		
	1,6	M8 (5m)	3	13	111,602	2183	IRCM 93 / 100 L 4b		
	2,0	M8 (5m)	3	16	87,936	1720	IRCM 93 / 100 L 4b		
	2,3	M8 (5m)	4	18	79,841	2083	IRCM 93 / 112 M 4b		
	2,6	M8 (5m)	4	21	66,785	1742	IRCM 93 / 112 M 4b		
	2,9	M8 (5m)	4	23	61,444	1603	IRCM 93 / 112 M 4b		
	3,3	M8 (5m)	5,5	26	54,545	1956	IRCM 93 / 132 S 4c		
	3,9	M8 (5m)	5,5	31	44,753	1605	IRCM 93 / 132 S 4c		
	4,8	M8 (5m)	7,5	38	37,199	1819	IRCM 93 / 132 M 4b		
	5,1	M8 (5m)	7,5	41	34,034	1665	IRCM 93 / 132 M 4b		
	5,7	M8 (5m)	9,2	45	31,194	1872	IRCM 93 / 132 M 4c		



Vinç sistemleri kaldırma redüktörleri güç ve devir tabloları / Power and ratio table for hoisting applications / Tableau de classification des couples et rapports de réduction pour les applications de levage



D _T Tambur Çapı Drum Diameter Diamètre de l'arbre [mm]	V _h Kaldırma Hızı Lifting Speeds Vitesse de levage [m/min]	Vinç Sınıfı Crane Class Classification de l'application de levage ISO (FEM)	P ₁ Motor Gücü Power Puissance [kW]	n ₂ Çıkış Devri Output Speeds Vitesse de sortie [r.p.m]	i Tahvil Ratio Rapport de réduction	M ₂ Çıkış Momenti Output Torque Couple de sortie	Tip Type Typ		 kg
Ø170	0,6	M8 (5m)	1,1	8,6	162,826	1168	IRCM 93 / 90 S 4a		
	0,6	M8 (5m)	1,1	9,5	146,946	1054	IRCM 93 / 90 S 4a		
	0,7	M8 (5m)	1,1	10	133,419	957	IRCM 93 / 90 S 4a		
	0,9	M8 (5m)	1,5	13	111,602	1092	IRCM 93 / 90 L 4a		
	1,1	M8 (5m)	1,5	16	87,936	860	IRCM 93 / 90 L 4a		
	1,2	M8 (5m)	2,2	18	79,841	1145	IRCM 93 / 100 L 4a		
	1,4	M8 (5m)	2,2	21	66,785	958	IRCM 93 / 100 L 4a		
	1,5	M8 (5m)	2,2	23	61,444	882	IRCM 93 / 100 L 4a		
	1,7	M8 (5m)	3	26	54,545	1067	IRCM 93 / 100 L 4b		
	2,1	M8 (5m)	3	31	44,753	876	IRCM 93 / 100 L 4b		
	2,5	M8 (5m)	4	38	37,199	970	IRCM 93 / 112 M 4b		
	2,7	M8 (5m)	4	41	34,034	888	IRCM 93 / 112 M 4b		
	3,0	M8 (5m)	5,5	45	31,194	1119	IRCM 93 / 132 S 4c		
	0,7	M8 (5m)	1,1	10	133,509	958	IRCM 83 / 90 S 4a		
	0,8	M8 (5m)	1,5	12	121,711	1191	IRCM 83 / 90 L 4a		
	0,9	M8 (5m)	1,5	14	102,407	1002	IRCM 83 / 90 L 4a		
	1,0	M8 (5m)	1,5	15	92,330	903	IRCM 83 / 90 L 4a		
	1,3	M8 (5m)	2,2	19	75,613	1085	IRCM 83 / 100 L 4a		
	1,5	M8 (5m)	2,2	23	60,299	865	IRCM 83 / 100 L 4a		
	1,7	M8 (5m)	3	26	54,358	1063	IRCM 83 / 100 L 4b		
1,9	M8 (5m)	3	29	48,314	945	IRCM 83 / 100 L 4b			
2,3	M8 (5m)	4	35	39,796	1038	IRCM 83 / 112 M 4b			
2,8	M8 (5m)	4	42	33,003	861	IRCM 83 / 112 M 4b			
3,4	M8 (5m)	5,5	51	27,535	988	IRCM 83 / 132 S 4c			
Ø180	0,6	M8 (5m)	1,1	8,6	162,826	1168	IRCM 93 / 90 S 4a		
	0,7	M8 (5m)	1,1	9,5	146,946	1054	IRCM 93 / 90 S 4a		
	0,7	M8 (5m)	1,1	10	133,419	957	IRCM 93 / 90 S 4a		
	0,9	M8 (5m)	1,5	13	111,602	1092	IRCM 93 / 90 L 4a		
	1,1	M8 (5m)	2,2	16	87,936	1262	IRCM 93 / 100 L 4a		
	1,3	M8 (5m)	2,2	18	79,841	1145	IRCM 93 / 100 L 4a		
	1,5	M8 (5m)	2,2	21	66,785	958	IRCM 93 / 100 L 4a		
	1,6	M8 (5m)	3	23	61,444	1202	IRCM 93 / 100 L 4b		
	1,8	M8 (5m)	3	26	54,545	1067	IRCM 93 / 100 L 4b		
	2,2	M8 (5m)	4	31	44,753	1167	IRCM 93 / 112 M 4b		
	2,7	M8 (5m)	4	38	37,199	970	IRCM 93 / 112 M 4b		
	2,9	M8 (5m)	4	41	34,034	888	IRCM 93 / 112 M 4b		
	3,2	M8 (5m)	5,5	45	31,194	1119	IRCM 93 / 132 S 4c		
	0,7	M8 (5m)	1,1	10	133,509	958	IRCM 83 / 90 S 4a		
	0,8	M8 (5m)	1,5	12	121,711	1191	IRCM 83 / 90 L 4a		
	1,0	M8 (5m)	1,5	14	102,407	1002	IRCM 83 / 90 L 4a		
	1,1	M8 (5m)	1,5	15	92,330	903	IRCM 83 / 90 L 4a		
	1,3	M8 (5m)	2,2	19	75,613	1085	IRCM 83 / 100 L 4a		
	1,6	M8 (5m)	3	23	60,299	1180	IRCM 83 / 100 L 4b		
	1,8	M8 (5m)	3	26	54,358	1063	IRCM 83 / 100 L 4b		
2,0	M8 (5m)	3	29	48,314	945	IRCM 83 / 100 L 4b			
2,5	M8 (5m)	4	35	39,796	1038	IRCM 83 / 112 M 4b			
3,0	M8 (5m)	5,5	42	33,003	1184	IRCM 83 / 132 S 4c			
3,6	M8 (5m)	5,5	51	27,535	988	IRCM 83 / 132 S 4c			





D _T Tambur Çapı Drum Diameter <i>Diamètre de l'arbre</i> [mm]	V _h Kaldırma Hızı Lifting Speeds <i>Vitesse de levage</i> [m/min]	Vinç Sınıfı Crane Class <i>Classification de l'application de levage</i> ISO (FEM)	P ₁ Motor Gücü Power <i>Puissance</i> [kW]	n ₂ Çıkış Devri Output Speeds <i>Vitesse de sortie</i> [r.p.m]	i Tahvil Ratio <i>Rapport de réduction</i>	M ₂ Çıkış Momenti Output Torque <i>Couple de sortie</i>	Tip Type <i>Typ</i>			kg
Ø190	0,6	M8 (5m)	1,1	8,6	162,826	1168	IRCM 93 / 90 S 4a			
	0,7	M8 (5m)	1,1	9,5	146,946	1054	IRCM 93 / 90 S 4a			
	0,7	M8 (5m)	1,1	10	133,419	957	IRCM 93 / 90 S 4a			
	1,0	M8 (5m)	1,5	13	111,602	1092	IRCM 93 / 90 L 4a			
	1,2	M8 (5m)	2,2	16	87,936	1262	IRCM 93 / 100 L 4a			
	1,3	M8 (5m)	2,2	18	79,841	1145	IRCM 93 / 100 L 4a			
	1,6	M8 (5m)	2,2	21	66,785	958	IRCM 93 / 100 L 4a			
	1,7	M8 (5m)	3	23	61,444	1202	IRCM 93 / 100 L 4b			
	1,9	M8 (5m)	3	26	54,545	1067	IRCM 93 / 100 L 4b			
	2,3	M8 (5m)	4	31	44,753	1167	IRCM 93 / 112 M 4b			
	2,8	M8 (5m)	4	38	37,199	970	IRCM 93 / 112 M 4b			
	3,1	M8 (5m)	5,5	41	34,034	1221	IRCM 93 / 132 S 4c			
	3,4	M8 (5m)	5,5	45	31,194	1119	IRCM 93 / 132 S 4c			
	0,7	M8 (5m)	1,1	10	133,509	958	IRCM 83 / 90 S 4a			
	0,9	M8 (5m)	1,5	12	121,711	1191	IRCM 83 / 90 L 4a			
	1,0	M8 (5m)	1,5	14	102,407	1002	IRCM 83 / 90 L 4a			
	1,1	M8 (5m)	2,2	15	92,330	1325	IRCM 83 / 100 L 4a			
	1,4	M8 (5m)	2,2	19	75,613	1085	IRCM 83 / 100 L 4a			
	1,7	M8 (5m)	3	23	60,299	1180	IRCM 83 / 100 L 4b			
	1,9	M8 (5m)	3	26	54,358	1063	IRCM 83 / 100 L 4b			
	2,2	M8 (5m)	3	29	48,314	945	IRCM 83 / 100 L 4b			
	2,6	M8 (5m)	4	35	39,796	1038	IRCM 83 / 112 M 4b			
3,1	M7 (4m)	5,5	42	33,003	1184	IRCM 83 / 132 S 4c				
3,8	M7 (4m)	5,5	51	27,535	988	IRCM 83 / 132 S 4c				
Ø200	0,7	M8 (5m)	1,1	8,6	162,826	1168	IRCM 93 / 90 S 4a			
	0,7	M8 (5m)	1,1	9,5	146,946	1054	IRCM 93 / 90 S 4a			
	0,8	M8 (5m)	1,1	10	133,419	957	IRCM 93 / 90 S 4a			
	1,0	M8 (5m)	1,5	13	111,602	1092	IRCM 93 / 90 L 4a			
	1,3	M8 (5m)	2,2	16	87,936	1262	IRCM 93 / 100 L 4a			
	1,4	M8 (5m)	2,2	18	79,841	1145	IRCM 93 / 100 L 4a			
	1,6	M8 (5m)	3	21	66,785	1307	IRCM 93 / 100 L 4b			
	1,8	M8 (5m)	3	23	61,444	1202	IRCM 93 / 100 L 4b			
	2,0	M8 (5m)	3	26	54,545	1067	IRCM 93 / 100 L 4b			
	2,4	M8 (5m)	4	31	44,753	1167	IRCM 93 / 112 M 4b			
	3,0	M8 (5m)	5,5	38	37,199	1334	IRCM 93 / 132 S 4c			
	3,2	M8 (5m)	5,5	41	34,034	1221	IRCM 93 / 132 S 4c			
	3,5	M8 (5m)	5,5	45	31,194	1119	IRCM 93 / 132 S 4c			
	0,8	M8 (5m)	1,1	10	133,509	958	IRCM 83 / 90 S 4a			
	0,9	M8 (5m)	1,5	12	121,711	1191	IRCM 83 / 90 L 4a			
	1,1	M8 (5m)	2,2	14	102,407	1469	IRCM 83 / 100 L 4a			
	1,2	M8 (5m)	2,2	15	92,330	1325	IRCM 83 / 100 L 4a			
	1,5	M8 (5m)	2,2	19	75,613	1085	IRCM 83 / 100 L 4a			
	1,8	M8 (5m)	3	23	60,299	1180	IRCM 83 / 100 L 4b			
	2,0	M8 (5m)	3	26	54,358	1063	IRCM 83 / 100 L 4b			
	2,3	M8 (5m)	4	29	48,314	1260	IRCM 83 / 112 M 4b			
	2,7	M7 (4m)	4	35	39,796	1038	IRCM 83 / 112 M 4b			
3,3	M7 (4m)	5,5	42	33,003	1184	IRCM 83 / 132 S 4c				
4,0	M7 (4m)	7,5	51	27,535	1347	IRCM 83 / 132 M 4b				



Vinç sistemleri kaldırma redüktörleri güç ve devir tabloları / Power and ratio table for hoisting applications / Tableau de classification des couples et rapports de réduction pour les applications de levage

D _T Tambur Çapı Drum Diameter Diamètre de l'arbre [mm]	V _h Kaldırma Hızı Lifting Speeds Vitesse de levage [m/min]	Vinç Sınıfı Crane Class Classification de l'application de levage ISO (FEM)	P ₁ Motor Gücü Power Puissance [kW]	n ₂ Çıkış Devri Output Speeds Vitesse de sortie [r.p.m]	i Tahvil Ratio Rapport de réduction	M ₂ Çıkış Momenti Output Torque Couple de sortie	Tip Type Typ		 kg
Ø210	0,7	M8 (5m)	1,1	8,6	162,826	1168	IRCM 93 / 90 S 4a		
	0,8	M8 (5m)	1,1	9,5	146,946	1054	IRCM 93 / 90 S 4a		
	0,8	M8 (5m)	1,5	10	133,419	1305	IRCM 93 / 90 L 4a		
	1,1	M8 (5m)	1,5	13	111,602	1092	IRCM 93 / 90 L 4a		
	1,3	M8 (5m)	2,2	16	87,936	1262	IRCM 93 / 100 L 4a		
	1,5	M8 (5m)	2,2	18	79,841	1145	IRCM 93 / 100 L 4a		
	1,7	M8 (5m)	3	21	66,785	1307	IRCM 93 / 100 L 4b		
	1,9	M8 (5m)	3	23	61,444	1202	IRCM 93 / 100 L 4b		
	2,1	M8 (5m)	3	26	54,545	1067	IRCM 93 / 100 L 4b		
	2,6	M8 (5m)	4	31	44,753	1167	IRCM 93 / 112 M 4b		
	3,1	M8 (5m)	5,5	38	37,199	1334	IRCM 93 / 132 S 4c		
	3,4	M8 (5m)	5,5	41	34,034	1221	IRCM 93 / 132 S 4c		
	3,7	M8 (5m)	5,5	45	31,194	1119	IRCM 93 / 132 S 4c		
	0,8	M8 (5m)	1,5	10	133,509	1306	IRCM 83 / 90 L 4a		
	1,0	M8 (5m)	1,5	12	121,711	1191	IRCM 83 / 90 L 4a		
	1,2	M8 (5m)	2,2	14	102,407	1469	IRCM 83 / 100 L 4a		
	1,2	M8 (5m)	2,2	15	92,330	1325	IRCM 83 / 100 L 4a		
	1,6	M7 (4m)	2,2	19	75,613	1085	IRCM 83 / 100 L 4a		
	1,9	M7 (4m)	3	23	60,299	1180	IRCM 83 / 100 L 4b		
	2,1	M7 (4m)	3	26	54,358	1063	IRCM 83 / 100 L 4b		
2,4	M7 (4m)	4	29	48,314	1260	IRCM 83 / 112 M 4b			
2,9	M7 (4m)	4	35	39,796	1038	IRCM 83 / 112 M 4b			
3,5	M7 (4m)	5,5	42	33,003	1184	IRCM 83 / 132 S 4c			
4,2	M7 (4m)	7,5	51	27,535	1347	IRCM 83 / 132 M 4b			
Ø220	0,7	M8 (5m)	1,1	8,6	162,826	1168	IRCM 93 / 90 S 4a		
	0,8	M8 (5m)	1,5	9,5	146,946	1437	IRCM 93 / 90 L 4a		
	0,9	M8 (5m)	1,5	10	133,419	1305	IRCM 93 / 90 L 4a		
	1,1	M8 (5m)	2,2	13	111,602	1601	IRCM 93 / 100 L 4a		
	1,4	M8 (5m)	2,2	16	87,936	1262	IRCM 93 / 100 L 4a		
	1,6	M8 (5m)	2,2	18	79,841	1145	IRCM 93 / 100 L 4a		
	1,8	M8 (5m)	3	21	66,785	1307	IRCM 93 / 100 L 4b		
	2,0	M8 (5m)	3	23	61,444	1202	IRCM 93 / 100 L 4b		
	2,2	M8 (5m)	4	26	54,545	1423	IRCM 93 / 112 M 4b		
	2,7	M8 (5m)	4	31	44,753	1167	IRCM 93 / 112 M 4b		
	3,3	M8 (5m)	5,5	38	37,199	1334	IRCM 93 / 132 S 4c		
	3,5	M8 (5m)	5,5	41	34,034	1221	IRCM 93 / 132 S 4c		
	3,9	M8 (5m)	5,5	45	31,194	1119	IRCM 93 / 132 S 4c		
	0,9	M7 (4m)	1,5	10	133,509	1306	IRCM 83 / 90 L 4a		
	1,0	M7 (4m)	1,5	12	121,711	1191	IRCM 83 / 90 L 4a		
	1,2	M7 (4m)	2,2	14	102,407	1469	IRCM 83 / 100 L 4a		
	1,3	M7 (4m)	2,2	15	92,330	1325	IRCM 83 / 100 L 4a		
	1,6	M7 (4m)	3	19	75,613	1479	IRCM 83 / 100 L 4b		
	2,0	M7 (4m)	3	23	60,299	1180	IRCM 83 / 100 L 4b		
	2,2	M7 (4m)	4	26	54,358	1418	IRCM 83 / 112 M 4b		
2,5	M7 (4m)	4	29	48,314	1260	IRCM 83 / 112 M 4b			
3,0	M7 (4m)	5,5	35	39,796	1427	IRCM 83 / 132 S 4c			
3,6	M7 (4m)	5,5	42	33,003	1184	IRCM 83 / 132 S 4c			
4,4	M7 (4m)	7,5	51	27,535	1347	IRCM 83 / 132 M 4b			





D _T Tambur Çapı Drum Diameter <i>Diamètre de l'arbre</i> [mm]	V _h Kaldırma Hızı Lifting Speeds <i>Vitesse de levage</i> [m/min]	Vinç Sınıfı Crane Class <i>Classification de l'application de levage</i> ISO (FEM)	P ₁ Motor Gücü Power <i>Puissance</i> [kW]	n ₂ Çıkış Devri Output Speeds <i>Vitesse de sortie</i> [r.p.m]	i Tahvil Ratio <i>Rapport de réduction</i>	M ₂ Çıkış Momenti Output Torque <i>Couple de sortie</i>	Tip Type <i>Typ</i>		 kg
Ø230	0,8	M8 (5m)	1,1	8,6	162,826	1168	IRCM 93 / 90 S 4a		
	0,9	M8 (5m)	1,5	9,5	146,946	1437	IRCM 93 / 90 L 4a		
	0,9	M8 (5m)	1,5	10	133,419	1305	IRCM 93 / 90 L 4a		
	1,2	M8 (5m)	2,2	13	111,602	1601	IRCM 93 / 100 L 4a		
	1,4	M8 (5m)	2,2	16	87,936	1262	IRCM 93 / 100 L 4a		
	1,6	M8 (5m)	3	18	79,841	1562	IRCM 93 / 100 L 4b		
	1,9	M8 (5m)	3	21	66,785	1307	IRCM 93 / 100 L 4b		
	2,1	M8 (5m)	3	23	61,444	1202	IRCM 93 / 100 L 4b		
	2,3	M8 (5m)	4	26	54,545	1423	IRCM 93 / 112 M 4b		
	2,8	M8 (5m)	4	31	44,753	1167	IRCM 93 / 112 M 4b		
	3,4	M8 (5m)	5,5	38	37,199	1334	IRCM 93 / 132 S 4c		
	3,7	M8 (5m)	5,5	41	34,034	1221	IRCM 93 / 132 S 4c		
	4,1	M8 (5m)	7,5	45	31,194	1526	IRCM 93 / 132 M 4b		
	0,9	M7 (4m)	1,5	10	133,509	1306	IRCM 83 / 90 L 4a		
	1,1	M7 (4m)	1,5	12	121,711	1191	IRCM 83 / 90 L 4a		
	1,3	M7 (4m)	2,2	14	102,407	1469	IRCM 83 / 100 L 4a		
	1,4	M7 (4m)	2,2	15	92,330	1325	IRCM 83 / 100 L 4a		
	1,7	M7 (4m)	3	19	75,613	1479	IRCM 83 / 100 L 4b		
	2,1	M7 (4m)	3	23	60,299	1180	IRCM 83 / 100 L 4b		
	2,3	M7 (4m)	4	26	54,358	1418	IRCM 83 / 112 M 4b		
2,6	M7 (4m)	4	29	48,314	1260	IRCM 83 / 112 M 4b			
3,2	M7 (4m)	5,5	35	39,796	1427	IRCM 83 / 132 S 4c			
3,8	M7 (4m)	5,5	42	33,003	1184	IRCM 83 / 132 S 4c			
4,6	M7 (4m)	7,5	51	27,535	1347	IRCM 83 / 132 M 4b			
Ø240	0,8	M8 (5m)	1,5	8,6	162,826	1593	IRCM 93 / 90 L 4a		
	0,9	M8 (5m)	1,5	9,5	146,946	1437	IRCM 93 / 90 L 4a		
	0,9	M8 (5m)	1,5	10	133,419	1305	IRCM 93 / 90 L 4a		
	1,2	M8 (5m)	2,2	13	111,602	1601	IRCM 93 / 100 L 4a		
	1,5	M8 (5m)	2,2	16	87,936	1262	IRCM 93 / 100 L 4a		
	1,7	M8 (5m)	3	18	79,841	1562	IRCM 93 / 100 L 4b		
	2,0	M8 (5m)	3	21	66,785	1307	IRCM 93 / 100 L 4b		
	2,2	M8 (5m)	3	23	61,444	1202	IRCM 93 / 100 L 4b		
	2,4	M8 (5m)	4	26	54,545	1423	IRCM 93 / 112 M 4b		
	2,9	M8 (5m)	5,5	31	44,753	1605	IRCM 93 / 132 S 4c		
	3,6	M8 (5m)	5,5	38	37,199	1334	IRCM 93 / 132 S 4c		
	3,9	M8 (5m)	5,5	41	34,034	1221	IRCM 93 / 132 S 4c		
	4,2	M8 (5m)	7,5	45	31,194	1526	IRCM 93 / 132 M 4b		
	0,9	M7 (4m)	1,5	10	133,509	1306	IRCM 83 / 90 L 4a		
	1,1	M7 (4m)	2,2	12	121,711	1746	IRCM 83 / 100 L 4a		
	1,3	M7 (4m)	2,2	14	102,407	1469	IRCM 83 / 100 L 4a		
	1,4	M7 (4m)	2,2	15	92,330	1325	IRCM 83 / 100 L 4a		
	1,8	M7 (4m)	3	19	75,613	1479	IRCM 83 / 100 L 4b		
	2,2	M7 (4m)	3	23	60,299	1180	IRCM 83 / 100 L 4b		
	2,4	M7 (4m)	4	26	54,358	1418	IRCM 83 / 112 M 4b		
2,7	M7 (4m)	4	29	48,314	1260	IRCM 83 / 112 M 4b			
3,3	M7 (4m)	5,5	35	39,796	1427	IRCM 83 / 132 S 4c			
4,0	M6 (3m)	5,5	42	33,003	1184	IRCM 83 / 132 S 4c			
4,8	M6 (3m)	7,5	51	27,535	1347	IRCM 83 / 132 M 4b			



Vinc sistemleri kaldırma redüktörleri güç ve devir tabloları / Power and ratio table for hoisting applications / Tableau de classification des couples et rapports de réduction pour les applications de levage

D _T Tambur Çapı Drum Diameter Diamètre de l'arbre [mm]	V _h Kaldırma Hızı Lifting Speeds Vitesse de levage [m/min]	Vinc Sınıfı Crane Class Classification de l'application de levage ISO (FEM)	P ₁ Motor Gücü Power Puissance [kW]	n ₂ Çıkış Devri Output Speeds Vitesse de sortie [r.p.m]	i Tahvil Ratio Rapport de réduction	M ₂ Çıkış Momenti Output Torque Couple de sortie	Tip Type Typ		 kg
Ø300	3,3	M8 (5m)	7,5	7,1	198,333	9700	IRCM 123 / 132 M 4b		
	4,1	M8 (5m)	7,5	8,7	161,000	7874	IRCM 123 / 132 M 4b		
	4,7	M7 (4m)	9,2	10	134,473	8068	IRCM 123 / 132 M 4c		
	5,7	M7 (4m)	11	12	118,333	8489	IRCM 123 / 160 M 4b		
	6,1	M7 (4m)	11	13	105,000	7532	IRCM 123 / 160 M 4b		
	7,1	M7 (4m)	15	15	93,800	9175	IRCM 123 / 160 L 4a		
	8,0	M7 (4m)	15	17	84,259	8242	IRCM 123 / 160 L 4a		
	8,9	M7 (4m)	18,5	19	73,179	8829	IRCM 123 / 180 M 4b		
	10	M7 (4m)	18,5	22	64,396	7769	IRCM 123 / 180 M 4b		
	12	M7 (4m)	22	25	57,140	8198	IRCM 123 / 180 L 4b		
	13	M7 (4m)	22	27	51,045	7323	IRCM 123 / 180 L 4b		
	15	M7 (4m)	30	31	45,853	8971	IRCM 123 / 200 L 4c		
	3,3	M6 (3m)	7,5	7,0	199,476	9756	IRCM 103 / 132 M 4b		
	3,7	M6 (3m)	7,5	7,9	177,284	8671	IRCM 103 / 132 M 4b		
	4,6	M6 (3m)	9,2	10	143,552	8613	IRCM 103 / 132 M 4c		
	5,7	M6 (3m)	11	12	119,126	8545	IRCM 103 / 160 M 4b		
	6,1	M6 (3m)	11	13	109,276	7839	IRCM 103 / 160 M 4b		
	7,1	M6 (3m)	15	15	95,896	9380	IRCM 103 / 160 L 4a		
	8,5	M6 (3m)	15	18	78,692	7698	IRCM 103 / 160 L 4a		
	8,9	M6 (3m)	18,5	19	71,869	8671	IRCM 103 / 180 M 4b		
11,3	M6 (3m)	22	24	58,778	8433	IRCM 103 / 180 L 4b			
12,7	M6 (3m)	22	27	51,907	7447	IRCM 103 / 180 L 4b			
Ø320	3,6	M7 (4m)	7,5	7,1	198,333	9700	IRCM 123 / 132 M 4b		
	4,4	M7 (4m)	9,2	8,7	161,000	9659	IRCM 123 / 132 M 4c		
	5,0	M7 (4m)	9,2	10	134,473	8068	IRCM 123 / 132 M 4c		
	6,0	M7 (4m)	11	12	118,333	8489	IRCM 123 / 160 M 4b		
	6,5	M7 (4m)	15	13	105,000	10271	IRCM 123 / 160 L 4a		
	7,5	M7 (4m)	15	15	93,800	9175	IRCM 123 / 160 L 4a		
	8,5	M7 (4m)	15	17	84,259	8242	IRCM 123 / 160 L 4a		
	9,5	M7 (4m)	18,5	19	73,179	8829	IRCM 123 / 180 M 4b		
	11	M7 (4m)	22	22	64,396	9239	IRCM 123 / 180 L 4b		
	13	M7 (4m)	22	25	57,140	8198	IRCM 123 / 180 L 4b		
	14	M7 (4m)	30	27	51,045	9986	IRCM 123 / 200 L 4c		
	16	M7 (4m)	30	31	45,853	8971	IRCM 123 / 200 L 4c		
	3,5	M6 (3m)	7,5	7,0	199,476	9756	IRCM 103 / 132 M 4b		
	4,0	M6 (3m)	7,5	7,9	177,284	8671	IRCM 103 / 132 M 4b		
	4,9	M6 (3m)	9,2	10	143,552	8613	IRCM 103 / 132 M 4c		
	6,0	M6 (3m)	11	12	119,126	8545	IRCM 103 / 160 M 4b		
	6,5	M6 (3m)	15	13	109,276	10689	IRCM 103 / 160 L 4a		
	7,5	M6 (3m)	15	15	95,896	9380	IRCM 103 / 160 L 4a		
	9,0	M6 (3m)	18,5	18	78,692	9494	IRCM 103 / 180 M 4b		
	9,5	M6 (3m)	18,5	19	71,869	8671	IRCM 103 / 180 M 4b		
12,1	M6 (3m)	22	24	58,778	8433	IRCM 103 / 180 L 4b			
13,6	M5 (2m)	30	27	51,907	10155	IRCM 103 / 200 L 4c			
Ø340	3,8	M7 (4m)	7,5	7,1	198,333	9700	IRCM 123 / 132 M 4b		
	4,6	M7 (4m)	9,2	8,7	161,000	9659	IRCM 123 / 132 M 4c		
	5,3	M7 (4m)	9,2	10	134,473	8068	IRCM 123 / 132 M 4c		
	6,4	M7 (4m)	15	12	118,333	11575	IRCM 123 / 160 L 4a		
	6,9	M7 (4m)	15	13	105,000	10271	IRCM 123 / 160 L 4a		
	8,0	M7 (4m)	15	15	93,800	9175	IRCM 123 / 160 L 4a		
	9,1	M7 (4m)	18,5	17	84,259	10165	IRCM 123 / 180 M 4b		
	10	M7 (4m)	18,5	19	73,179	8829	IRCM 123 / 180 M 4b		
	12	M7 (4m)	22	22	64,396	9239	IRCM 123 / 180 L 4b		
	13	M7 (4m)	30	25	57,140	11179	IRCM 123 / 200 L 4c		
	14	M7 (4m)	30	27	51,045	9986	IRCM 123 / 200 L 4c		
	17	M7 (4m)	30	31	45,853	8971	IRCM 123 / 200 L 4c		





D _T Tambur Çapı Drum Diameter <i>Diamètre de l'arbre</i> [mm]	V _h Kaldırma Hızı Lifting Speeds <i>Vitesse de levage</i> [m/min]	Vinç Sınıfı Crane Class <i>Classification de l'application de levage</i> ISO (FEM)	P ₁ Motor Gücü Power <i>Puissance</i> [kW]	n ₂ Çıkış Devri Output Speeds <i>Vitesse de sortie</i> [r.p.m]	i Tahvil Ratio <i>Rapport de réduction</i>	M ₂ Çıkış Momenti Output Torque <i>Couple de sortie</i>	Tip Type <i>Typ</i>		 kg
	3,7	M6 (3m)	7,5	7,0	199,476	9756	IRCM 103 / 132 M 4b		
	4,2	M6 (3m)	7,5	7,9	177,284	8671	IRCM 103 / 132 M 4b		
	5,2	M6 (3m)	9,2	10	143,552	8613	IRCM 103 / 132 M 4c		
	6,4	M6 (3m)	15	12	119,126	11653	IRCM 103 / 160 L 4a		
	6,9	M6 (3m)	15	13	109,276	10689	IRCM 103 / 160 L 4a		
	8,0	M6 (3m)	15	15	95,896	9380	IRCM 103 / 160 L 4a		
	9,6	M6 (3m)	18,5	18	78,692	9494	IRCM 103 / 180 M 4b		
	10,1	M5 (2m)	18,5	19	71,869	8671	IRCM 103 / 180 M 4b		
	12,8	M5 (2m)	30	24	58,778	11499	IRCM 103 / 200 L 4c		
	14,4	M5 (2m)	30	27	51,907	10155	IRCM 103 / 200 L 4c		
Ø360	4,0	M7 (4m)	7,5	7,1	198,333	9700	IRCM 123 / 132 M 4b		
	4,9	M7 (4m)	9,2	8,7	161,000	9659	IRCM 123 / 132 M 4c		
	5,7	M7 (4m)	11	10	134,473	9646	IRCM 123 / 160 M 4b		
	6,8	M7 (4m)	15	12	118,333	11575	IRCM 123 / 160 L 4a		
	7,3	M7 (4m)	15	13	105,000	10271	IRCM 123 / 160 L 4a		
	8,5	M7 (4m)	15	15	93,800	9175	IRCM 123 / 160 L 4a		
	9,6	M7 (4m)	18,5	17	84,259	10165	IRCM 123 / 180 M 4b		
	11	M7 (4m)	18,5	19	73,179	8829	IRCM 123 / 180 M 4b		
	12	M7 (4m)	22	22	64,396	9239	IRCM 123 / 180 L 4b		
	14	M7 (4m)	30	25	57,140	11179	IRCM 123 / 200 L 4c		
	15	M7 (4m)	30	27	51,045	9986	IRCM 123 / 200 L 4c		
	18	M7 (4m)	37	31	45,853	11064	IRCM 123 / 225 S 4a		
	4,0	M5 (2m)	7,5	7,0	199,476	9756	IRCM 103 / 132 M 4b		
	4,5	M5 (2m)	9,2	7,9	177,284	10636	IRCM 103 / 132 M 4c		
	5,5	M5 (2m)	11	10	143,552	10298	IRCM 103 / 160 M 4b		
	6,8	M5 (2m)	15	12	119,126	11653	IRCM 103 / 160 L 4a		
	7,3	M5 (2m)	15	13	109,276	10689	IRCM 103 / 160 L 4a		
	8,5	M5 (2m)	15	15	95,896	9380	IRCM 103 / 160 L 4a		
	10,2	M5 (2m)	18,5	18	78,692	9494	IRCM 103 / 180 M 4b		
	10,7	M5 (2m)	18,5	19	71,869	8671	IRCM 103 / 180 M 4b		
13,6	M5 (2m)	30	24	58,778	11499	IRCM 103 / 200 L 4c			
15,3	M4 (1Am)	30	27	51,907	10155	IRCM 103 / 200 L 4c			
Ø380	4,2	M7 (4m)	7,5	7,1	198,333	9700	IRCM 123 / 132 M 4b		
	5,2	M7 (4m)	9,2	8,7	161,000	9659	IRCM 123 / 132 M 4c		
	6,0	M6 (3m)	11	10	134,473	9646	IRCM 123 / 160 M 4b		
	7,2	M6 (3m)	15	12	118,333	11575	IRCM 123 / 160 L 4a		
	7,8	M6 (3m)	15	13	105,000	10271	IRCM 123 / 160 L 4a		
	8,9	M6 (3m)	18,5	15	93,800	11316	IRCM 123 / 180 M 4b		
	10	M6 (3m)	18,5	17	84,259	10165	IRCM 123 / 180 M 4b		
	11	M6 (3m)	22	19	73,179	10499	IRCM 123 / 180 L 4b		
	13	M6 (3m)	30	22	64,396	12598	IRCM 123 / 200 L 4c		
	15	M6 (3m)	30	25	57,140	11179	IRCM 123 / 200 L 4c		
	16	M6 (3m)	30	27	51,045	9986	IRCM 123 / 200 L 4c		
	18	M6 (3m)	37	31	45,853	11064	IRCM 123 / 225 S 4a		
	4,2	M5 (2m)	7,5	7,0	199,476	9756	IRCM 103 / 132 M 4b		
	4,7	M5 (2m)	9,2	7,9	177,284	10636	IRCM 103 / 132 M 4c		
	5,8	M5 (2m)	11	10	143,552	10298	IRCM 103 / 160 M 4b		
	7,2	M5 (2m)	15	12	119,126	11653	IRCM 103 / 160 L 4a		
	7,8	M5 (2m)	15	13	109,276	10689	IRCM 103 / 160 L 4a		
	8,9	M5 (2m)	18,5	15	95,896	11569	IRCM 103 / 180 M 4b		
	10,7	M5 (2m)	18,5	18	78,692	9494	IRCM 103 / 180 M 4b		
	11,3	M5 (2m)	22	19	71,869	10311	IRCM 103 / 180 L 4b		
14,3	M4 (1Am)	30	24	58,778	11499	IRCM 103 / 200 L 4c			
16,1	M4 (1Am)	30	27	51,907	10155	IRCM 103 / 200 L 4c			



Vinç sistemleri kaldırma redüktörleri güç ve devir tabloları / Power and ratio table for hoisting applications / Tableau de classification des couples et rapports de réduction pour les applications de levage



D _T Tambur Çapı Drum Diameter <i>Diamètre de l'arbre</i> [mm]	V _h Kaldırma Hızı Lifting Speeds <i>Vitesse de levage</i> [m/min]	Vinç Sınıfı Crane Class <i>Classification de l'application de levage</i> ISO (FEM)	P ₁ Motor Gücü Power <i>Puissance</i> [kW]	n ₂ Çıkış Devri Output Speeds <i>Vitesse de sortie</i> [r.p.m]	i Tahvil Ratio <i>Rapport de réduction</i>	M ₂ Çıkış Momenti Output Torque <i>Couple de sortie</i>	Tip Type <i>Typ</i>		 kg
Ø400	4,5	M6 (3m)	9,2	7,1	198,333	11899	IRCM 123 / 132 M 4c		
	5,5	M6 (3m)	11	8,7	161,000	11549	IRCM 123 / 160 M 4b		
	6,3	M6 (3m)	11	10	134,473	9646	IRCM 123 / 160 M 4b		
	7,5	M6 (3m)	15	12	118,333	11575	IRCM 123 / 160 L 4a		
	8,2	M6 (3m)	15	13	105,000	10271	IRCM 123 / 160 L 4a		
	9,4	M6 (3m)	18,5	15	93,800	11316	IRCM 123 / 180 M 4b		
	11	M6 (3m)	18,5	17	84,259	10165	IRCM 123 / 180 M 4b		
	12	M6 (3m)	22	19	73,179	10499	IRCM 123 / 180 L 4b		
	14	M6 (3m)	30	22	64,396	12598	IRCM 123 / 200 L 4c		
	16	M6 (3m)	30	25	57,140	11179	IRCM 123 / 200 L 4c		
	17	M6 (3m)	30	27	51,045	9986	IRCM 123 / 200 L 4c		
	19	M6 (3m)	37	31	45,853	11064	IRCM 123 / 225 S 4a		
	4,4	M4 (1Am)	9,2	7,0	199,476	11968	IRCM 103 / 132 M 4c		
	5,0	M4 (1Am)	9,2	7,9	177,284	10636	IRCM 103 / 132 M 4c		
	6,2	M4 (1Am)	11	10	143,552	10298	IRCM 103 / 160 M 4b		
	7,5	M4 (1Am)	15	12	119,126	11653	IRCM 103 / 160 L 4a		
	8,2	M4 (1Am)	15	13	109,276	10689	IRCM 103 / 160 L 4a		
	9,4	M4 (1Am)	18,5	15	95,896	11569	IRCM 103 / 180 M 4b		
	11,3	M4 (1Am)	22	18	78,692	11290	IRCM 103 / 180 L 4b		
	11,9	M4 (1Am)	22	19	71,869	10311	IRCM 103 / 180 L 4b		
15,1	M4 (1Am)	30	24	58,778	11499	IRCM 103 / 200 L 4c			
17,0	M3 (1Bm)	30	27	51,907	10155	IRCM 103 / 200 L 4c			
Ø420	4,7	M6 (3m)	9,2	7,1	198,333	11899	IRCM 123 / 132 M 4c		
	5,7	M6 (3m)	11	8,7	161,000	11549	IRCM 123 / 160 M 4b		
	6,6	M6 (3m)	15	10	134,473	13154	IRCM 123 / 160 L 4a		
	7,9	M6 (3m)	15	12	118,333	11575	IRCM 123 / 160 L 4a		
	8,6	M6 (3m)	15	13	105,000	10271	IRCM 123 / 160 L 4a		
	9,9	M6 (3m)	18,5	15	93,800	11316	IRCM 123 / 180 M 4b		
	11	M6 (3m)	22	17	84,259	12088	IRCM 123 / 180 L 4b		
	13	M6 (3m)	22	19	73,179	10499	IRCM 123 / 180 L 4b		
	15	M6 (3m)	30	22	64,396	12598	IRCM 123 / 200 L 4c		
	16	M6 (3m)	30	25	57,140	11179	IRCM 123 / 200 L 4c		
	18	M6 (3m)	37	27	51,045	12317	IRCM 123 / 225 S 4a		
	20	M6 (3m)	37	31	45,853	11064	IRCM 123 / 225 S 4a		
	4,6	M4 (1Am)	9,2	7,0	199,476	11968	IRCM 103 / 132 M 4c		
	5,2	M4 (1Am)	9,2	7,9	177,284	10636	IRCM 103 / 132 M 4c		
	6,5	M4 (1Am)	15	10	143,552	14042	IRCM 103 / 160 L 4a		
	7,9	M4 (1Am)	15	12	119,126	11653	IRCM 103 / 160 L 4a		
	8,6	M4 (1Am)	15	13	109,276	10689	IRCM 103 / 160 L 4a		
	9,9	M4 (1Am)	18,5	15	95,896	11569	IRCM 103 / 180 M 4b		
	11,9	M4 (1Am)	22	18	78,692	11290	IRCM 103 / 180 L 4b		
	12,5	M4 (1Am)	22	19	71,869	10311	IRCM 103 / 180 L 4b		
15,8	M4 (1Am)	30	24	58,778	11499	IRCM 103 / 200 L 4c			
17,8	M3 (1Bm)	37	27	51,907	12525	IRCM 103 / 225 S 4a			
Ø440	4,9	M6 (3m)	9,2	7,1	198,333	11899	IRCM 123 / 132 M 4c		
	6,0	M6 (3m)	11	8,7	161,000	11549	IRCM 123 / 160 M 4b		
	6,9	M6 (3m)	15	10	134,473	13154	IRCM 123 / 160 L 4a		
	8,3	M6 (3m)	15	12	118,333	11575	IRCM 123 / 160 L 4a		
	9,0	M6 (3m)	18,5	13	105,000	12668	IRCM 123 / 180 M 4b		
	10	M6 (3m)	18,5	15	93,800	11316	IRCM 123 / 180 M 4b		
	12	M6 (3m)	22	17	84,259	12088	IRCM 123 / 180 L 4b		
	13	M6 (3m)	30	19	73,179	14317	IRCM 123 / 200 L 4c		
	15	M6 (3m)	30	22	64,396	12598	IRCM 123 / 200 L 4c		
	17	M6 (3m)	30	25	57,140	11179	IRCM 123 / 200 L 4c		
	19	M6 (3m)	37	27	51,045	12317	IRCM 123 / 225 S 4a		
	21	M6 (3m)	37	31	45,853	11064	IRCM 123 / 225 S 4a		





D _T Tambur Çapı Drum Diameter <i>Diamètre de l'arbre</i> [mm]	V _h Kaldırma Hızı Lifting Speeds <i>Vitesse de levage</i> [m/min]	Vinç Sınıfı Crane Class <i>Classification de l'application de levage</i> ISO (FEM)	P ₁ Motor Gücü Power <i>Puissance</i> [kW]	n ₂ Çıkış Devri Output Speeds <i>Vitesse de sortie</i> [r.p.m]	i Tahvil Ratio <i>Rapport de réduction</i>	M ₂ Çıkış Momenti Output Torque <i>Couple de sortie</i>	Tip Type <i>Typ</i>		 kg
Ø270	1,5	M8 (5m)	3	7,0	199,476	3903	IRCM 103 / 100 L 4b		
	1,7	M8 (5m)	3	7,9	177,284	3468	IRCM 103 / 100 L 4b		
	2,1	M8 (5m)	4	10	143,552	3745	IRCM 103 / 112 M 4b		
	2,5	M8 (5m)	5,5	12	119,126	4273	IRCM 103 / 132 S 4c		
	2,8	M8 (5m)	5,5	13	109,276	3919	IRCM 103 / 132 S 4c		
	3,2	M8 (5m)	5,5	15	95,896	3440	IRCM 103 / 132 S 4c		
	3,8	M8 (5m)	7,5	18	78,692	3849	IRCM 103 / 132 M 4b		
	4,0	M8 (5m)	7,5	19	71,869	3515	IRCM 103 / 132 M 4b		
	5,1	M8 (5m)	9,2	24	58,778	3526	IRCM 103 / 132 M 4c		
	5,7	M8 (5m)	11	27	51,907	3724	IRCM 103 / 160 M 4b		
	1,8	M7 (4m)	4	8,6	162,826	4247	IRCM 93 / 112 M 4b		
	2,0	M7 (4m)	4	9,5	146,946	3833	IRCM 93 / 112 M 4b		
	2,1	M6 (3m)	4	10	133,419	3480	IRCM 93 / 112 M 4b		
	2,8	M6 (3m)	5,5	13	111,602	4003	IRCM 93 / 132 S 4c		
	3,4	M6 (3m)	7,5	16	87,936	4301	IRCM 93 / 132 M 4b		
	3,8	M6 (3m)	7,5	18	79,841	3905	IRCM 93 / 132 M 4b		
	4,5	M6 (3m)	9,2	21	66,785	4007	IRCM 93 / 132 M 4c		
	4,9	M6 (3m)	9,2	23	61,444	3686	IRCM 93 / 132 M 4c		
	5,5	M5 (2m)	11	26	54,545	3913	IRCM 93 / 160 M 4b		
	6,6	M5 (2m)	15	31	44,753	4378	IRCM 93 / 160 L 4a		
8,1	M5 (2m)	15	38	37,199	3639	IRCM 93 / 160 L 4a			
8,7	M5 (2m)	15	41	34,034	3329	IRCM 93 / 160 L 4a			
9,5	M5 (2m)	18,5	45	31,194	3763	IRCM 93 / 180 M 4b			
Ø280	1,5	M8 (5m)	3	7,0	199,476	3903	IRCM 103 / 100 L 4b		
	1,7	M8 (5m)	3	7,9	177,284	3468	IRCM 103 / 100 L 4b		
	2,2	M8 (5m)	4	10	143,552	3745	IRCM 103 / 112 M 4b		
	2,6	M8 (5m)	5,5	12	119,126	4273	IRCM 103 / 132 S 4c		
	2,9	M8 (5m)	5,5	13	109,276	3919	IRCM 103 / 132 S 4c		
	3,3	M8 (5m)	7,5	15	95,896	4690	IRCM 103 / 132 M 4b		
	4,0	M8 (5m)	7,5	18	78,692	3849	IRCM 103 / 132 M 4b		
	4,2	M8 (5m)	7,5	19	71,869	3515	IRCM 103 / 132 M 4b		
	5,3	M8 (5m)	9,2	24	58,778	3526	IRCM 103 / 132 M 4c		
	5,9	M8 (5m)	11	27	51,907	3724	IRCM 103 / 160 M 4b		
	1,9	M6 (3m)	4	8,6	162,826	4247	IRCM 93 / 112 M 4b		
	2,1	M6 (3m)	4	9,5	146,946	3833	IRCM 93 / 112 M 4b		
	2,2	M6 (3m)	4	10	133,419	3480	IRCM 93 / 112 M 4b		
	2,9	M6 (3m)	5,5	13	111,602	4003	IRCM 93 / 132 S 4c		
	3,5	M6 (3m)	7,5	16	87,936	4301	IRCM 93 / 132 M 4b		
	4,0	M6 (3m)	7,5	18	79,841	3905	IRCM 93 / 132 M 4b		
	4,6	M6 (3m)	9,2	21	66,785	4007	IRCM 93 / 132 M 4c		
	5,1	M6 (3m)	9,2	23	61,444	3686	IRCM 93 / 132 M 4c		
	5,7	M5 (2m)	11	26	54,545	3913	IRCM 93 / 160 M 4b		
	6,8	M5 (2m)	15	31	44,753	4378	IRCM 93 / 160 L 4a		
8,4	M5 (2m)	15	38	37,199	3639	IRCM 93 / 160 L 4a			
9,0	M5 (2m)	18,5	41	34,034	4106	IRCM 93 / 180 M 4b			
9,9	M5 (2m)	18,5	45	31,194	3763	IRCM 93 / 180 M 4b			
	1,6	M8 (5m)	3	7,0	199,476	3903	IRCM 103 / 100 L 4b		
	1,8	M8 (5m)	4	7,9	177,284	4624	IRCM 103 / 112 M 4b		
	2,2	M8 (5m)	4	10	143,552	3745	IRCM 103 / 112 M 4b		
	2,7	M8 (5m)	5,5	12	119,126	4273	IRCM 103 / 132 S 4c		
	3,0	M8 (5m)	5,5	13	109,276	3919	IRCM 103 / 132 S 4c		
	3,4	M8 (5m)	7,5	15	95,896	4690	IRCM 103 / 132 M 4b		
	4,1	M8 (5m)	7,5	18	78,692	3849	IRCM 103 / 132 M 4b		
	4,3	M8 (5m)	7,5	19	71,869	3515	IRCM 103 / 132 M 4b		
	5,5	M8 (5m)	11	24	58,778	4216	IRCM 103 / 160 M 4b		
	6,1	M8 (5m)	11	27	51,907	3724	IRCM 103 / 160 M 4b		



Vinç sistemleri kaldırma redüktörleri güç ve devir tabloları / Power and ratio table for hoisting applications / Tableau de classification des couples et rapports de réduction pour les applications de levage

D _T Tambur Çapı Drum Diameter <i>Diamètre de l'arbre</i> [mm]	V _h Kaldırma Hızı Lifting Speeds <i>Vitesse de levage</i> [m/min]	Vinç Sınıfı Crane Class <i>Classification de l'application de levage</i> ISO (FEM)	P ₁ Motor Gücü Power <i>Puissance</i> [kW]	n ₂ Çıkış Devri Output Speeds <i>Vitesse de sortie</i> [r.p.m]	i Tahvil Ratio <i>Rapport de réduction</i>	M ₂ Çıkış Momenti Output Torque <i>Couple de sortie</i>	Tip Type <i>Typ</i>		 kg
Ø290	2,0	M6 (3m)	4	8,6	162,826	4247	IRCM 93 / 112 M 4b		
	2,2	M6 (3m)	4	9,5	146,946	3833	IRCM 93 / 112 M 4b		
	2,3	M6 (3m)	4	10	133,419	3480	IRCM 93 / 112 M 4b		
	3,0	M6 (3m)	5,5	13	111,602	4003	IRCM 93 / 132 S 4c		
	3,6	M6 (3m)	7,5	16	87,936	4301	IRCM 93 / 132 M 4b		
	4,1	M6 (3m)	7,5	18	79,841	3905	IRCM 93 / 132 M 4b		
	4,8	M5 (2m)	9,2	21	66,785	4007	IRCM 93 / 132 M 4c		
	5,2	M5 (2m)	9,2	23	61,444	3686	IRCM 93 / 132 M 4c		
	5,9	M5 (2m)	11	26	54,545	3913	IRCM 93 / 160 M 4b		
	7,1	M4 (1Am)	15	31	44,753	4378	IRCM 93 / 160 L 4a		
	8,7	M4 (1Am)	15	38	37,199	3639	IRCM 93 / 160 L 4a		
	9,3	M4 (1Am)	18,5	41	34,034	4106	IRCM 93 / 180 M 4b		
10	M4 (1Am)	18,5	45	31,194	3763	IRCM 93 / 180 M 4b			
Ø300	1,6	M8 (5m)	3	7,0	199,476	3903	IRCM 103 / 100 L 4b		
	1,9	M8 (5m)	4	7,9	177,284	4624	IRCM 103 / 112 M 4b		
	2,3	M8 (5m)	4	10	143,552	3745	IRCM 103 / 112 M 4b		
	2,8	M8 (5m)	5,5	12	119,126	4273	IRCM 103 / 132 S 4c		
	3,1	M8 (5m)	5,5	13	109,276	3919	IRCM 103 / 132 S 4c		
	3,5	M8 (5m)	7,5	15	95,896	4690	IRCM 103 / 132 M 4b		
	4,2	M8 (5m)	7,5	18	78,692	3849	IRCM 103 / 132 M 4b		
	4,5	M8 (5m)	9,2	19	71,869	4312	IRCM 103 / 132 M 4c		
	5,7	M8 (5m)	11	24	58,778	4216	IRCM 103 / 160 M 4b		
	6,4	M8 (5m)	11	27	51,907	3724	IRCM 103 / 160 M 4b		
	2,0	M6 (3m)	4	8,6	162,826	4247	IRCM 93 / 112 M 4b		
	2,2	M6 (3m)	4	9,5	146,946	3833	IRCM 93 / 112 M 4b		
	2,4	M6 (3m)	5,5	10	133,419	4785	IRCM 93 / 132 S 4c		
	3,1	M6 (3m)	5,5	13	111,602	4003	IRCM 93 / 132 S 4c		
	3,8	M6 (3m)	7,5	16	87,936	4301	IRCM 93 / 132 M 4b		
	4,2	M5 (2m)	7,5	18	79,841	3905	IRCM 93 / 132 M 4b		
	4,9	M5 (2m)	9,2	21	66,785	4007	IRCM 93 / 132 M 4c		
	5,4	M5 (2m)	11	23	61,444	4408	IRCM 93 / 160 M 4b		
	6,1	M5 (2m)	11	26	54,545	3913	IRCM 93 / 160 M 4b		
	7,3	M4 (1Am)	15	31	44,753	4378	IRCM 93 / 160 L 4a		
	8,9	M4 (1Am)	18,5	38	37,199	4488	IRCM 93 / 180 M 4b		
	9,7	M4 (1Am)	18,5	41	34,034	4106	IRCM 93 / 180 M 4b		
	11	M4 (1Am)	18,5	45	31,194	3763	IRCM 93 / 180 M 4b		
	1,7	M8 (5m)	3	7,0	199,476	3903	IRCM 103 / 100 L 4b		
1,9	M8 (5m)	4	7,9	177,284	4624	IRCM 103 / 112 M 4b			
2,4	M8 (5m)	5,5	10	143,552	5149	IRCM 103 / 132 S 4c			
2,9	M8 (5m)	5,5	12	119,126	4273	IRCM 103 / 132 S 4c			
3,2	M8 (5m)	5,5	13	109,276	3919	IRCM 103 / 132 S 4c			
3,7	M8 (5m)	7,5	15	95,896	4690	IRCM 103 / 132 M 4b			
4,4	M8 (5m)	9,2	18	78,692	4721	IRCM 103 / 132 M 4c			
4,6	M8 (5m)	9,2	19	71,869	4312	IRCM 103 / 132 M 4c			
5,8	M8 (5m)	11	24	58,778	4216	IRCM 103 / 160 M 4b			
6,6	M8 (5m)	15	27	51,907	5078	IRCM 103 / 160 L 4a			





D _T Tambur Çapı Drum Diameter <i>Diamètre de l'arbre</i> [mm]	V _h Kaldırma Hızı Lifting Speeds <i>Vitesse de levage</i> [m/min]	Vinç Sınıfı Crane Class <i>Classification de l'application de levage</i> ISO (FEM)	P ₁ Motor Gücü Power <i>Puissance</i> [kW]	n ₂ Çıkış Devri Output Speeds <i>Vitesse de sortie</i> [r.p.m]	i Tahvil Ratio <i>Rapport de réduction</i>	M ₂ Çıkış Momenti Output Torque <i>Couple de sortie</i>	Tip Type <i>Typ</i>		 kg
Ø310	2,1	M6 (3m)	4	8,6	162,826	4247	IRCM 93 / 112 M 4b		
	2,3	M6 (3m)	4	9,5	146,946	3833	IRCM 93 / 112 M 4b		
	2,4	M6 (3m)	5,5	10	133,419	4785	IRCM 93 / 132 S 4c		
	3,2	M6 (3m)	5,5	13	111,602	4003	IRCM 93 / 132 S 4c		
	3,9	M5 (2m)	7,5	16	87,936	4301	IRCM 93 / 132 M 4b		
	4,4	M5 (2m)	9,2	18	79,841	4790	IRCM 93 / 132 M 4c		
	5,1	M5 (2m)	9,2	21	66,785	4007	IRCM 93 / 132 M 4c		
	5,6	M5 (2m)	11	23	61,444	4408	IRCM 93 / 160 M 4b		
	6,3	M4 (1Am)	11	26	54,545	3913	IRCM 93 / 160 M 4b		
	7,5	M4 (1Am)	15	31	44,753	4378	IRCM 93 / 160 L 4a		
	9,2	M4 (1Am)	18,5	38	37,199	4488	IRCM 93 / 180 M 4b		
	10	M4 (1Am)	18,5	41	34,034	4106	IRCM 93 / 180 M 4b		
	11	M4 (1Am)	22	45	31,194	4475	IRCM 93 / 180 L 4b		
Ø320	1,8	M8 (5m)	4	7,0	199,476	5203	IRCM 103 / 112 M 4b		
	2,0	M8 (5m)	4	7,9	177,284	4624	IRCM 103 / 112 M 4b		
	2,5	M8 (5m)	5,5	10	143,552	5149	IRCM 103 / 132 S 4c		
	3,0	M8 (5m)	5,5	12	119,126	4273	IRCM 103 / 132 S 4c		
	3,3	M8 (5m)	7,5	13	109,276	5345	IRCM 103 / 132 M 4b		
	3,8	M8 (5m)	7,5	15	95,896	4690	IRCM 103 / 132 M 4b		
	4,5	M8 (5m)	9,2	18	78,692	4721	IRCM 103 / 132 M 4c		
	4,8	M8 (5m)	9,2	19	71,869	4312	IRCM 103 / 132 M 4c		
	6,0	M8 (5m)	11	24	58,778	4216	IRCM 103 / 160 M 4b		
	6,8	M8 (5m)	15	27	51,907	5078	IRCM 103 / 160 L 4a		
	2,2	M6 (3m)	4	8,6	162,826	4247	IRCM 93 / 112 M 4b		
	2,4	M6 (3m)	5,5	9,5	146,946	5271	IRCM 93 / 132 S 4c		
	2,5	M6 (3m)	5,5	10	133,419	4785	IRCM 93 / 132 S 4c		
	3,3	M5 (2m)	7,5	13	111,602	5458	IRCM 93 / 132 M 4b		
	4,0	M5 (2m)	7,5	16	87,936	4301	IRCM 93 / 132 M 4b		
	4,5	M5 (2m)	9,2	18	79,841	4790	IRCM 93 / 132 M 4c		
	5,3	M4 (1Am)	9,2	21	66,785	4007	IRCM 93 / 132 M 4c		
	5,8	M4 (1Am)	11	23	61,444	4408	IRCM 93 / 160 M 4b		
	6,5	M4 (1Am)	15	26	54,545	5336	IRCM 93 / 160 L 4a		
7,8	M4 (1Am)	15	31	44,753	4378	IRCM 93 / 160 L 4a			
9,5	M4 (1Am)	18,5	38	37,199	4488	IRCM 93 / 180 M 4b			
Ø330	1,8	M8 (5m)	4	7,0	199,476	5203	IRCM 103 / 112 M 4b		
	2,0	M8 (5m)	4	7,9	177,284	4624	IRCM 103 / 112 M 4b		
	2,5	M8 (5m)	5,5	10	143,552	5149	IRCM 103 / 132 S 4c		
	3,1	M8 (5m)	5,5	12	119,126	4273	IRCM 103 / 132 S 4c		
	3,4	M8 (5m)	7,5	13	109,276	5345	IRCM 103 / 132 M 4b		
	3,9	M8 (5m)	7,5	15	95,896	4690	IRCM 103 / 132 M 4b		
	4,7	M8 (5m)	9,2	18	78,692	4721	IRCM 103 / 132 M 4c		
	4,9	M8 (5m)	9,2	19	71,869	4312	IRCM 103 / 132 M 4c		
	6,2	M8 (5m)	11	24	58,778	4216	IRCM 103 / 160 M 4b		
	7,0	M8 (5m)	15	27	51,907	5078	IRCM 103 / 160 L 4a		
	2,2	M6 (3m)	4	8,6	162,826	4247	IRCM 93 / 112 M 4b		
	2,5	M6 (3m)	5,5	9,5	146,946	5271	IRCM 93 / 132 S 4c		
	2,6	M5 (2m)	5,5	10	133,419	4785	IRCM 93 / 132 S 4c		
	3,4	M5 (2m)	7,5	13	111,602	5458	IRCM 93 / 132 M 4b		
	4,1	M5 (2m)	7,5	16	87,936	4301	IRCM 93 / 132 M 4b		
	4,7	M5 (2m)	9,2	18	79,841	4790	IRCM 93 / 132 M 4c		
	5,4	M4 (1Am)	11	21	66,785	4791	IRCM 93 / 160 M 4b		
	6,0	M4 (1Am)	11	23	61,444	4408	IRCM 93 / 160 M 4b		
	6,7	M4 (1Am)	15	26	54,545	5336	IRCM 93 / 160 L 4a		
8,0	M4 (1Am)	15	31	44,753	4378	IRCM 93 / 160 L 4a			
9,8	M3 (1Bm)	18,5	38	37,199	4488	IRCM 93 / 180 M 4b			



Vinç sistemleri kaldırma redüktörleri güç ve devir tabloları / Power and ratio table for hoisting applications / Tableau de classification des couples et rapports de réduction pour les applications de levage



D _T Tambur Çapı Drum Diameter Diamètre de l'arbre [mm]	V _h Kaldırma Hızı Lifting Speeds Vitesse de levage [m/min]	Vinç Sınıfı Crane Class Classification de l'application de levage ISO (FEM)	P ₁ Motor Gücü Power Puissance [kW]	n ₂ Çıkış Devri Output Speeds Vitesse de sortie [r.p.m]	i Tahvil Ratio Rapport de réduction	M ₂ Çıkış Momenti Output Torque Couple de sortie	Tip Type Typ		 kg
Ø340	1,9	M8 (5m)	4	7,0	199,476	5203	IRCM 103 / 112 M 4b		
	2,1	M8 (5m)	4	7,9	177,284	4624	IRCM 103 / 112 M 4b		
	2,6	M8 (5m)	5,5	10	143,552	5149	IRCM 103 / 132 S 4c		
	3,2	M8 (5m)	7,5	12	119,126	5826	IRCM 103 / 132 M 4b		
	3,5	M8 (5m)	7,5	13	109,276	5345	IRCM 103 / 132 M 4b		
	4,0	M8 (5m)	7,5	15	95,896	4690	IRCM 103 / 132 M 4b		
	4,8	M8 (5m)	9,2	18	78,692	4721	IRCM 103 / 132 M 4c		
	5,1	M8 (5m)	9,2	19	71,869	4312	IRCM 103 / 132 M 4c		
	6,4	M8 (5m)	15	24	58,778	5750	IRCM 103 / 160 L 4a		
	7,2	M8 (5m)	15	27	51,907	5078	IRCM 103 / 160 L 4a		
	2,3	M5 (2m)	4	8,6	162,826	4247	IRCM 93 / 112 M 4b		
	2,5	M5 (2m)	5,5	9,5	146,946	5271	IRCM 93 / 132 S 4c		
	2,7	M5 (2m)	5,5	10	133,419	4785	IRCM 93 / 132 S 4c		
	3,5	M5 (2m)	7,5	13	111,602	5458	IRCM 93 / 132 M 4b		
	4,3	M5 (2m)	7,5	16	87,936	4301	IRCM 93 / 132 M 4b		
	4,8	M4 (1Am)	9,2	18	79,841	4790	IRCM 93 / 132 M 4c		
	5,6	M4 (1Am)	11	21	66,785	4791	IRCM 93 / 160 M 4b		
	6,1	M4 (1Am)	11	23	61,444	4408	IRCM 93 / 160 M 4b		
	6,9	M4 (1Am)	15	26	54,545	5336	IRCM 93 / 160 L 4a		
	8,3	M3 (1Bm)	15	31	44,753	4378	IRCM 93 / 160 L 4a		
10	M3 (1Bm)	18,5	38	37,199	4488	IRCM 93 / 180 M 4b			





D _T Tambur Çapı Drum Diameter <i>Diamètre de l'arbre</i> [mm]	V _h Kaldırma Hızı Lifting Speeds <i>Vitesse de levage</i> [m/min]	Vinç Sınıfı Crane Class <i>Classification de l'application de levage</i> ISO (FEM)	P ₁ Motor Gücü Power <i>Puissance</i> [kW]	n ₂ Çıkış Devri Output Speeds <i>Vitesse de sortie</i> [r.p.m]	i Tahvil Ratio <i>Rapport de réduction</i>	M ₂ Çıkış Momenti Output Torque <i>Couple de sortie</i>	Tip Type <i>Typ</i>		 kg
Ø170	0,8	M8 (5m)	1,5	8,6	162,826	1593	IRCM 93 / 90 L 4a		
	0,8	M8 (5m)	1,5	9,5	146,946	1437	IRCM 93 / 90 L 4a		
	0,9	M8 (5m)	2,2	10	133,419	1914	IRCM 93 / 100 L 4a		
	1,2	M8 (5m)	2,2	13	111,602	1601	IRCM 93 / 100 L 4a		
	1,4	M8 (5m)	3	16	87,936	1720	IRCM 93 / 100 L 4b		
	1,6	M8 (5m)	3	18	79,841	1562	IRCM 93 / 100 L 4b		
	1,9	M8 (5m)	4	21	66,785	1742	IRCM 93 / 112 M 4b		
	2,0	M8 (5m)	4	23	61,444	1603	IRCM 93 / 112 M 4b		
	2,3	M8 (5m)	4	26	54,545	1423	IRCM 93 / 112 M 4b		
	2,8	M8 (5m)	5,5	31	44,753	1605	IRCM 93 / 132 S 4c		
	3,4	M8 (5m)	7,5	38	37,199	1819	IRCM 93 / 132 M 4b		
	3,6	M8 (5m)	7,5	41	34,034	1665	IRCM 93 / 132 M 4b		
	4,0	M8 (5m)	7,5	45	31,194	1526	IRCM 93 / 132 M 4b		
	0,9	M6 (3m)	2,2	10	133,509	1915	IRCM 83 / 100 L 4a		
	1,1	M6 (3m)	2,2	12	121,711	1746	IRCM 83 / 100 L 4a		
	1,2	M6 (3m)	2,2	14	102,407	1469	IRCM 83 / 100 L 4a		
	1,3	M6 (3m)	3	15	92,330	1806	IRCM 83 / 100 L 4b		
	1,7	M6 (3m)	3	19	75,613	1479	IRCM 83 / 100 L 4b		
	2,0	M6 (3m)	4	23	60,299	1573	IRCM 83 / 112 M 4b		
	2,3	M6 (3m)	4	26	54,358	1418	IRCM 83 / 112 M 4b		
	2,6	M6 (3m)	5,5	29	48,314	1733	IRCM 83 / 132 S 4c		
	3,1	M6 (3m)	5,5	35	39,796	1427	IRCM 83 / 132 S 4c		
3,7	M6 (3m)	7,5	42	33,003	1614	IRCM 83 / 132 M 4b			
4,5	M6 (3m)	9,2	51	27,535	1652	IRCM 83 / 132 M 4c			
Ø180	0,8	M8 (5m)	1,5	8,6	162,826	1593	IRCM 93 / 90 L 4a		
	0,9	M8 (5m)	2,2	9,5	146,946	2108	IRCM 93 / 100 L 4a		
	0,9	M8 (5m)	2,2	10	133,419	1914	IRCM 93 / 100 L 4a		
	1,2	M8 (5m)	2,2	13	111,602	1601	IRCM 93 / 100 L 4a		
	1,5	M8 (5m)	3	16	87,936	1720	IRCM 93 / 100 L 4b		
	1,7	M8 (5m)	3	18	79,841	1562	IRCM 93 / 100 L 4b		
	2,0	M8 (5m)	4	21	66,785	1742	IRCM 93 / 112 M 4b		
	2,2	M8 (5m)	4	23	61,444	1603	IRCM 93 / 112 M 4b		
	2,4	M8 (5m)	5,5	26	54,545	1956	IRCM 93 / 132 S 4c		
	2,9	M8 (5m)	5,5	31	44,753	1605	IRCM 93 / 132 S 4c		
	3,6	M8 (5m)	7,5	38	37,199	1819	IRCM 93 / 132 M 4b		
	3,9	M8 (5m)	7,5	41	34,034	1665	IRCM 93 / 132 M 4b		
	4,2	M8 (5m)	7,5	45	31,194	1526	IRCM 93 / 132 M 4b		
	0,9	M6 (3m)	2,2	10	133,509	1915	IRCM 83 / 100 L 4a		
	1,1	M6 (3m)	2,2	12	121,711	1746	IRCM 83 / 100 L 4a		
	1,3	M6 (3m)	3	14	102,407	2003	IRCM 83 / 100 L 4b		
	1,4	M6 (3m)	3	15	92,330	1806	IRCM 83 / 100 L 4b		
	1,8	M6 (3m)	4	19	75,613	1972	IRCM 83 / 112 M 4b		
	2,2	M6 (3m)	4	23	60,299	1573	IRCM 83 / 112 M 4b		
	2,4	M6 (3m)	5,5	26	54,358	1950	IRCM 83 / 132 S 4c		
	2,7	M6 (3m)	5,5	29	48,314	1733	IRCM 83 / 132 S 4c		
	3,3	M6 (3m)	7,5	35	39,796	1946	IRCM 83 / 132 M 4b		
4,0	M5 (2m)	7,5	42	33,003	1614	IRCM 83 / 132 M 4b			
4,8	M5 (2m)	9,2	51	27,535	1652	IRCM 83 / 132 M 4c			





Vinç sistemleri kaldırma redüktörleri güç ve devir tabloları / Power and ratio table for hoisting applications / Tableau de classification des couples et rapports de réduction pour les applications de levage

D _T Tambur Çapı Drum Diameter Diamètre de l'arbre [mm]	V _h Kaldırma Hızı Lifting Speeds Vitesse de levage [m/min]	Vinç Sınıfı Crane Class Classification de l'application de levage ISO (FEM)	P ₁ Motor Gücü Power Puissance [kW]	n ₂ Çıkış Devri Output Speeds Vitesse de sortie [r.p.m]	i Tahvil Ratio Rapport de réduction	M ₂ Çıkış Momenti Output Torque Couple de sortie	Tip Type Typ		 kg
Ø190	0,9	M8 (5m)	1,5	8,6	162,826	1593	IRCM 93 / 90 L 4a		
	0,9	M8 (5m)	2,2	9,5	146,946	2108	IRCM 93 / 100 L 4a		
	1,0	M8 (5m)	2,2	10	133,419	1914	IRCM 93 / 100 L 4a		
	1,3	M8 (5m)	3	13	111,602	2183	IRCM 93 / 100 L 4b		
	1,6	M8 (5m)	3	16	87,936	1720	IRCM 93 / 100 L 4b		
	1,8	M8 (5m)	4	18	79,841	2083	IRCM 93 / 112 M 4b		
	2,1	M8 (5m)	4	21	66,785	1742	IRCM 93 / 112 M 4b		
	2,3	M8 (5m)	4	23	61,444	1603	IRCM 93 / 112 M 4b		
	2,6	M8 (5m)	5,5	26	54,545	1956	IRCM 93 / 132 S 4c		
	3,1	M8 (5m)	5,5	31	44,753	1605	IRCM 93 / 132 S 4c		
	3,8	M8 (5m)	7,5	38	37,199	1819	IRCM 93 / 132 M 4b		
	4,1	M8 (5m)	7,5	41	34,034	1665	IRCM 93 / 132 M 4b		
4,5	M8 (5m)	9,2	45	31,194	1872	IRCM 93 / 132 M 4c			
Ø200	0,9	M8 (5m)	2,2	8,6	162,826	2336	IRCM 93 / 100 L 4a		
	1,0	M8 (5m)	2,2	9,5	146,946	2108	IRCM 93 / 100 L 4a		
	1,0	M8 (5m)	2,2	10	133,419	1914	IRCM 93 / 100 L 4a		
	1,4	M8 (5m)	3	13	111,602	2183	IRCM 93 / 100 L 4b		
	1,7	M8 (5m)	3	16	87,936	1720	IRCM 93 / 100 L 4b		
	1,9	M8 (5m)	4	18	79,841	2083	IRCM 93 / 112 M 4b		
	2,2	M8 (5m)	4	21	66,785	1742	IRCM 93 / 112 M 4b		
	2,4	M8 (5m)	5,5	23	61,444	2204	IRCM 93 / 132 S 4c		
	2,7	M8 (5m)	5,5	26	54,545	1956	IRCM 93 / 132 S 4c		
	3,2	M8 (5m)	7,5	31	44,753	2189	IRCM 93 / 132 M 4b		
	4,0	M8 (5m)	7,5	38	37,199	1819	IRCM 93 / 132 M 4b		
	4,3	M8 (5m)	7,5	41	34,034	1665	IRCM 93 / 132 M 4b		
4,7	M8 (5m)	9,2	45	31,194	1872	IRCM 93 / 132 M 4c			
Ø210	0,9	M8 (5m)	2,2	8,6	162,826	2336	IRCM 93 / 100 L 4a		
	1,0	M8 (5m)	2,2	9,5	146,946	2108	IRCM 93 / 100 L 4a		
	1,1	M8 (5m)	2,2	10	133,419	1914	IRCM 93 / 100 L 4a		
	1,4	M8 (5m)	3	13	111,602	2183	IRCM 93 / 100 L 4b		
	1,8	M8 (5m)	4	16	87,936	2294	IRCM 93 / 112 M 4b		
	2,0	M8 (5m)	4	18	79,841	2083	IRCM 93 / 112 M 4b		
	2,3	M8 (5m)	4	21	66,785	1742	IRCM 93 / 112 M 4b		
	2,5	M8 (5m)	5,5	23	61,444	2204	IRCM 93 / 132 S 4c		
	2,9	M8 (5m)	5,5	26	54,545	1956	IRCM 93 / 132 S 4c		
	3,4	M8 (5m)	7,5	31	44,753	2189	IRCM 93 / 132 M 4b		
	4,2	M8 (5m)	7,5	38	37,199	1819	IRCM 93 / 132 M 4b		
	4,5	M8 (5m)	9,2	41	34,034	2042	IRCM 93 / 132 M 4c		
4,9	M8 (5m)	9,2	45	31,194	1872	IRCM 93 / 132 M 4c			
Ø220	1,0	M8 (5m)	2,2	8,6	162,826	2336	IRCM 93 / 100 L 4a		
	1,1	M8 (5m)	2,2	9,5	146,946	2108	IRCM 93 / 100 L 4a		
	1,2	M8 (5m)	2,2	10	133,419	1914	IRCM 93 / 100 L 4a		
	1,5	M8 (5m)	3	13	111,602	2183	IRCM 93 / 100 L 4b		
	1,8	M8 (5m)	4	16	87,936	2294	IRCM 93 / 112 M 4b		
	2,1	M8 (5m)	4	18	79,841	2083	IRCM 93 / 112 M 4b		
	2,4	M8 (5m)	5,5	21	66,785	2395	IRCM 93 / 132 S 4c		
	2,6	M8 (5m)	5,5	23	61,444	2204	IRCM 93 / 132 S 4c		
	3,0	M8 (5m)	5,5	26	54,545	1956	IRCM 93 / 132 S 4c		
	3,6	M8 (5m)	7,5	31	44,753	2189	IRCM 93 / 132 M 4b		
	4,4	M8 (5m)	9,2	38	37,199	2232	IRCM 93 / 132 M 4c		
	4,7	M8 (5m)	9,2	41	34,034	2042	IRCM 93 / 132 M 4c		
5,2	M8 (5m)	9,2	45	31,194	1872	IRCM 93 / 132 M 4c			





D _T Tambur Çapı Drum Diameter <i>Diamètre de l'arbre</i> [mm]	V _h Kaldırma Hızı Lifting Speeds <i>Vitesse de levage</i> [m/min]	Vinç Sınıfı Crane Class <i>Classification de l'application de levage</i> ISO (FEM)	P ₁ Motor Gücü Power <i>Puissance</i> [kW]	n ₂ Çıkış Devri Output Speeds <i>Vitesse de sortie</i> [r.p.m]	i Tahvil Ratio <i>Rapport de réduction</i>	M ₂ Çıkış Momenti Output Torque <i>Couple de sortie</i>	Tip Type <i>Typ</i>		 kg
Ø230	1,0	M8 (5m)	2,2	8,6	162,826	2336	IRCM 93 / 100 L 4a		
	1,1	M8 (5m)	2,2	9,5	146,946	2108	IRCM 93 / 100 L 4a		
	1,2	M8 (5m)	2,2	10	133,419	1914	IRCM 93 / 100 L 4a		
	1,6	M8 (5m)	3	13	111,602	2183	IRCM 93 / 100 L 4b		
	1,9	M8 (5m)	4	16	87,936	2294	IRCM 93 / 112 M 4b		
	2,2	M8 (5m)	4	18	79,841	2083	IRCM 93 / 112 M 4b		
	2,5	M8 (5m)	5,5	21	66,785	2395	IRCM 93 / 132 S 4c		
	2,8	M8 (5m)	5,5	23	61,444	2204	IRCM 93 / 132 S 4c		
	3,1	M8 (5m)	5,5	26	54,545	1956	IRCM 93 / 132 S 4c		
	3,7	M8 (5m)	7,5	31	44,753	2189	IRCM 93 / 132 M 4b		
	4,6	M8 (5m)	9,2	38	37,199	2232	IRCM 93 / 132 M 4c		
	4,9	M8 (5m)	9,2	41	34,034	2042	IRCM 93 / 132 M 4c		
	5,4	M8 (5m)	11	45	31,194	2238	IRCM 93 / 160 M 4b		
Ø240	1,1	M8 (5m)	2,2	8,6	162,826	2336	IRCM 93 / 100 L 4a		
	1,2	M8 (5m)	2,2	9,5	146,946	2108	IRCM 93 / 100 L 4a		
	1,3	M8 (5m)	2,2	10	133,419	1914	IRCM 93 / 100 L 4a		
	1,6	M8 (5m)	3	13	111,602	2183	IRCM 93 / 100 L 4b		
	2,0	M8 (5m)	4	16	87,936	2294	IRCM 93 / 112 M 4b		
	2,3	M8 (5m)	4	18	79,841	2083	IRCM 93 / 112 M 4b		
	2,6	M8 (5m)	5,5	21	66,785	2395	IRCM 93 / 132 S 4c		
	2,9	M8 (5m)	5,5	23	61,444	2204	IRCM 93 / 132 S 4c		
	3,3	M8 (5m)	7,5	26	54,545	2668	IRCM 93 / 132 M 4b		
	3,9	M8 (5m)	7,5	31	44,753	2189	IRCM 93 / 132 M 4b		
	4,8	M8 (5m)	9,2	38	37,199	2232	IRCM 93 / 132 M 4c		
	5,1	M8 (5m)	9,2	41	34,034	2042	IRCM 93 / 132 M 4c		
	5,7	M8 (5m)	11	45	31,194	2238	IRCM 93 / 160 M 4b		





D _T Tambur Çapı Drum Diameter Diamètre de l'arbre [mm]	V _h Kaldırma Hızı Lifting Speeds Vitesse de levage [m/min]	Vinç Sınıfı Crane Class Classification de l'application de levage ISO (FEM)	P ₁ Motor Gücü Power Puissance [kW]	n ₂ Çıkış Devri Output Speeds Vitesse de sortie [r.p.m]	i Tahvil Ratio Rapport de réduction	M ₂ Çıkış Momenti Output Torque Couple de sortie	Tip Type Typ		 kg
Ø170	0,6	M8 (5m)	1,1	8,6	162,826	1168	IRCM 93 / 90 S 4a		
	0,6	M8 (5m)	1,1	9,5	146,946	1054	IRCM 93 / 90 S 4a		
	0,7	M8 (5m)	1,5	10	133,419	1305	IRCM 93 / 90 L 4a		
	0,9	M8 (5m)	1,5	13	111,602	1092	IRCM 93 / 90 L 4a		
	1,1	M8 (5m)	2,2	16	87,936	1262	IRCM 93 / 100 L 4a		
	1,2	M8 (5m)	2,2	18	79,841	1145	IRCM 93 / 100 L 4a		
	1,4	M8 (5m)	3	21	66,785	1307	IRCM 93 / 100 L 4b		
	1,5	M8 (5m)	3	23	61,444	1202	IRCM 93 / 100 L 4b		
	1,7	M8 (5m)	3	26	54,545	1067	IRCM 93 / 100 L 4b		
	2,1	M8 (5m)	4	31	44,753	1167	IRCM 93 / 112 M 4b		
	2,5	M8 (5m)	5,5	38	37,199	1334	IRCM 93 / 132 S 4c		
	2,7	M8 (5m)	5,5	41	34,034	1221	IRCM 93 / 132 S 4c		
	3,0	M8 (5m)	5,5	45	31,194	1119	IRCM 93 / 132 S 4c		
	0,7	M8 (5m)	1,5	10	133,509	1306	IRCM 83 / 90 L 4a		
	0,8	M8 (5m)	1,5	12	121,711	1191	IRCM 83 / 90 L 4a		
	0,9	M8 (5m)	2,2	14	102,407	1469	IRCM 83 / 100 L 4a		
	1,0	M8 (5m)	2,2	15	92,330	1325	IRCM 83 / 100 L 4a		
	1,3	M7 (4m)	2,2	19	75,613	1085	IRCM 83 / 100 L 4a		
	1,5	M7 (4m)	3	23	60,299	1180	IRCM 83 / 100 L 4b		
	1,7	M7 (4m)	3	26	54,358	1063	IRCM 83 / 100 L 4b		
1,9	M7 (4m)	4	29	48,314	1260	IRCM 83 / 112 M 4b			
2,3	M7 (4m)	5,5	35	39,796	1427	IRCM 83 / 132 S 4c			
2,8	M7 (4m)	5,5	42	33,003	1184	IRCM 83 / 132 S 4c			
3,4	M7 (4m)	7,5	51	27,535	1347	IRCM 83 / 132 M 4b			
Ø180	0,6	M8 (5m)	1,1	8,6	162,826	1168	IRCM 93 / 90 S 4a		
	0,7	M8 (5m)	1,5	9,5	146,946	1437	IRCM 93 / 90 L 4a		
	0,7	M8 (5m)	1,5	10	133,419	1305	IRCM 93 / 90 L 4a		
	0,9	M8 (5m)	2,2	13	111,602	1601	IRCM 93 / 100 L 4a		
	1,1	M8 (5m)	2,2	16	87,936	1262	IRCM 93 / 100 L 4a		
	1,3	M8 (5m)	2,2	18	79,841	1145	IRCM 93 / 100 L 4a		
	1,5	M8 (5m)	3	21	66,785	1307	IRCM 93 / 100 L 4b		
	1,6	M8 (5m)	3	23	61,444	1202	IRCM 93 / 100 L 4b		
	1,8	M8 (5m)	4	26	54,545	1423	IRCM 93 / 112 M 4b		
	2,2	M8 (5m)	4	31	44,753	1167	IRCM 93 / 112 M 4b		
	2,7	M8 (5m)	5,5	38	37,199	1334	IRCM 93 / 132 S 4c		
	2,9	M8 (5m)	5,5	41	34,034	1221	IRCM 93 / 132 S 4c		
	3,2	M8 (5m)	5,5	45	31,194	1119	IRCM 93 / 132 S 4c		
	0,7	M7 (4m)	1,5	10	133,509	1306	IRCM 83 / 90 L 4a		
	0,8	M7 (4m)	1,5	12	121,711	1191	IRCM 83 / 90 L 4a		
	1,0	M7 (4m)	2,2	14	102,407	1469	IRCM 83 / 100 L 4a		
	1,1	M7 (4m)	2,2	15	92,330	1325	IRCM 83 / 100 L 4a		
	1,3	M7 (4m)	3	19	75,613	1479	IRCM 83 / 100 L 4b		
	1,6	M7 (4m)	3	23	60,299	1180	IRCM 83 / 100 L 4b		
	1,8	M7 (4m)	4	26	54,358	1418	IRCM 83 / 112 M 4b		
2,0	M7 (4m)	4	29	48,314	1260	IRCM 83 / 112 M 4b			
2,5	M7 (4m)	5,5	35	39,796	1427	IRCM 83 / 132 S 4c			
3,0	M7 (4m)	5,5	42	33,003	1184	IRCM 83 / 132 S 4c			
3,6	M7 (4m)	7,5	51	27,535	1347	IRCM 83 / 132 M 4b			



D _T Tambur Çapı Drum Diameter <i>Diamètre de l'arbre</i> [mm]	V _h Kaldırma Hızı Lifting Speeds <i>Vitesse de levage</i> [m/min]	Vinç Sınıfı Crane Class <i>Classification de l'application de levage</i> ISO (FEM)	P ₁ Motor Gücü Power <i>Puissance</i> [kW]	n ₂ Çıkış Devri Output Speeds <i>Vitesse de sortie</i> [r.p.m]	i Tahvil Ratio <i>Rapport de réduction</i>	M ₂ Çıkış Momenti Output Torque <i>Couple de sortie</i>	Tip Type <i>Typ</i>		 kg
Ø190	0,6	M8 (5m)	1,5	8,6	162,826	1593	IRCM 93 / 90 L 4a		
	0,7	M8 (5m)	1,5	9,5	146,946	1437	IRCM 93 / 90 L 4a		
	0,7	M8 (5m)	1,5	10	133,419	1305	IRCM 93 / 90 L 4a		
	1,0	M8 (5m)	2,2	13	111,602	1601	IRCM 93 / 100 L 4a		
	1,2	M8 (5m)	2,2	16	87,936	1262	IRCM 93 / 100 L 4a		
	1,3	M8 (5m)	3	18	79,841	1562	IRCM 93 / 100 L 4b		
	1,6	M8 (5m)	3	21	66,785	1307	IRCM 93 / 100 L 4b		
	1,7	M8 (5m)	3	23	61,444	1202	IRCM 93 / 100 L 4b		
	1,9	M8 (5m)	4	26	54,545	1423	IRCM 93 / 112 M 4b		
	2,3	M8 (5m)	4	31	44,753	1167	IRCM 93 / 112 M 4b		
	2,8	M8 (5m)	5,5	38	37,199	1334	IRCM 93 / 132 S 4c		
	3,1	M8 (5m)	5,5	41	34,034	1221	IRCM 93 / 132 S 4c		
	3,4	M8 (5m)	7,5	45	31,194	1526	IRCM 93 / 132 M 4b		
	0,7	M7 (4m)	1,5	10	133,509	1306	IRCM 83 / 90 L 4a		
	0,9	M7 (4m)	2,2	12	121,711	1746	IRCM 83 / 100 L 4a		
	1,0	M7 (4m)	2,2	14	102,407	1469	IRCM 83 / 100 L 4a		
	1,1	M7 (4m)	2,2	15	92,330	1325	IRCM 83 / 100 L 4a		
	1,4	M7 (4m)	3	19	75,613	1479	IRCM 83 / 100 L 4b		
	1,7	M7 (4m)	3	23	60,299	1180	IRCM 83 / 100 L 4b		
	1,9	M7 (4m)	4	26	54,358	1418	IRCM 83 / 112 M 4b		
	2,2	M7 (4m)	4	29	48,314	1260	IRCM 83 / 112 M 4b		
	2,6	M7 (4m)	5,5	35	39,796	1427	IRCM 83 / 132 S 4c		
3,1	M7 (4m)	5,5	42	33,003	1184	IRCM 83 / 132 S 4c			
3,8	M6 (3m)	7,5	51	27,535	1347	IRCM 83 / 132 M 4b			
Ø200	0,7	M8 (5m)	1,5	8,6	162,826	1593	IRCM 93 / 90 L 4a		
	0,7	M8 (5m)	1,5	9,5	146,946	1437	IRCM 93 / 90 L 4a		
	0,8	M8 (5m)	1,5	10	133,419	1305	IRCM 93 / 90 L 4a		
	1,0	M8 (5m)	2,2	13	111,602	1601	IRCM 93 / 100 L 4a		
	1,3	M8 (5m)	2,2	16	87,936	1262	IRCM 93 / 100 L 4a		
	1,4	M8 (5m)	3	18	79,841	1562	IRCM 93 / 100 L 4b		
	1,6	M8 (5m)	3	21	66,785	1307	IRCM 93 / 100 L 4b		
	1,8	M8 (5m)	4	23	61,444	1603	IRCM 93 / 112 M 4b		
	2,0	M8 (5m)	4	26	54,545	1423	IRCM 93 / 112 M 4b		
	2,4	M8 (5m)	5,5	31	44,753	1605	IRCM 93 / 132 S 4c		
	3,0	M8 (5m)	5,5	38	37,199	1334	IRCM 93 / 132 S 4c		
	3,2	M8 (5m)	7,5	41	34,034	1665	IRCM 93 / 132 M 4b		
	3,5	M8 (5m)	7,5	45	31,194	1526	IRCM 93 / 132 M 4b		
	0,8	M7 (4m)	1,5	10	133,509	1306	IRCM 83 / 90 L 4a		
	0,9	M7 (4m)	2,2	12	121,711	1746	IRCM 83 / 100 L 4a		
	1,1	M7 (4m)	2,2	14	102,407	1469	IRCM 83 / 100 L 4a		
	1,2	M7 (4m)	2,2	15	92,330	1325	IRCM 83 / 100 L 4a		
	1,5	M7 (4m)	3	19	75,613	1479	IRCM 83 / 100 L 4b		
	1,8	M7 (4m)	4	23	60,299	1573	IRCM 83 / 112 M 4b		
	2,0	M7 (4m)	4	26	54,358	1418	IRCM 83 / 112 M 4b		
	2,3	M7 (4m)	4	29	48,314	1260	IRCM 83 / 112 M 4b		
	2,7	M6 (3m)	5,5	35	39,796	1427	IRCM 83 / 132 S 4c		
3,3	M6 (3m)	7,5	42	33,003	1614	IRCM 83 / 132 M 4b			
4,0	M6 (3m)	7,5	51	27,535	1347	IRCM 83 / 132 M 4b			



Vinç sistemleri kaldırma redüktörleri güç ve devir tabloları / Power and ratio table for hoisting applications / Tableau de classification des couples et rapports de réduction pour les applications de levage



D _T Tambur Çapı Drum Diameter <i>Diamètre de l'arbre</i> [mm]	V _h Kaldırma Hızı Lifting Speeds <i>Vitesse de levage</i> [m/min]	Vinç Sınıfı Crane Class <i>Classification de l'application de levage</i> ISO (FEM)	P ₁ Motor Gücü Power <i>Puissance</i> [kW]	n ₂ Çıkış Devri Output Speeds <i>Vitesse de sortie</i> [r.p.m]	i Tahvil Ratio <i>Rapport de réduction</i>	M ₂ Çıkış Momenti Output Torque <i>Couple de sortie</i>	Tip Type <i>Typ</i>		 kg
Ø210	0,7	M8 (5m)	1,5	8,6	162,826	1593	IRCM 93 / 90 L 4a		
	0,8	M8 (5m)	1,5	9,5	146,946	1437	IRCM 93 / 90 L 4a		
	0,8	M8 (5m)	1,5	10	133,419	1305	IRCM 93 / 90 L 4a		
	1,1	M8 (5m)	2,2	13	111,602	1601	IRCM 93 / 100 L 4a		
	1,3	M8 (5m)	3	16	87,936	1720	IRCM 93 / 100 L 4b		
	1,5	M8 (5m)	3	18	79,841	1562	IRCM 93 / 100 L 4b		
	1,7	M8 (5m)	3	21	66,785	1307	IRCM 93 / 100 L 4b		
	1,9	M8 (5m)	4	23	61,444	1603	IRCM 93 / 112 M 4b		
	2,1	M8 (5m)	4	26	54,545	1423	IRCM 93 / 112 M 4b		
	2,6	M8 (5m)	5,5	31	44,753	1605	IRCM 93 / 132 S 4c		
	3,1	M8 (5m)	5,5	38	37,199	1334	IRCM 93 / 132 S 4c		
	3,4	M8 (5m)	7,5	41	34,034	1665	IRCM 93 / 132 M 4b		
	3,7	M8 (5m)	7,5	45	31,194	1526	IRCM 93 / 132 M 4b		
	0,8	M7 (4m)	1,5	10	133,509	1306	IRCM 83 / 90 L 4a		
	1,0	M7 (4m)	2,2	12	121,711	1746	IRCM 83 / 100 L 4a		
	1,2	M7 (4m)	2,2	14	102,407	1469	IRCM 83 / 100 L 4a		
	1,2	M7 (4m)	2,2	15	92,330	1325	IRCM 83 / 100 L 4a		
	1,6	M7 (4m)	3	19	75,613	1479	IRCM 83 / 100 L 4b		
	1,9	M7 (4m)	4	23	60,299	1573	IRCM 83 / 112 M 4b		
	2,1	M7 (4m)	4	26	54,358	1418	IRCM 83 / 112 M 4b		
2,4	M6 (3m)	5,5	29	48,314	1733	IRCM 83 / 132 S 4c			
2,9	M6 (3m)	5,5	35	39,796	1427	IRCM 83 / 132 S 4c			
3,5	M6 (3m)	7,5	42	33,003	1614	IRCM 83 / 132 M 4b			
4,2	M6 (3m)	7,5	51	27,535	1347	IRCM 83 / 132 M 4b			
Ø220	0,7	M8 (5m)	1,5	8,6	162,826	1593	IRCM 93 / 90 L 4a		
	0,8	M8 (5m)	1,5	9,5	146,946	1437	IRCM 93 / 90 L 4a		
	0,9	M8 (5m)	1,5	10	133,419	1305	IRCM 93 / 90 L 4a		
	1,1	M8 (5m)	2,2	13	111,602	1601	IRCM 93 / 100 L 4a		
	1,4	M8 (5m)	3	16	87,936	1720	IRCM 93 / 100 L 4b		
	1,6	M8 (5m)	3	18	79,841	1562	IRCM 93 / 100 L 4b		
	1,8	M8 (5m)	4	21	66,785	1742	IRCM 93 / 112 M 4b		
	2,0	M8 (5m)	4	23	61,444	1603	IRCM 93 / 112 M 4b		
	2,2	M8 (5m)	4	26	54,545	1423	IRCM 93 / 112 M 4b		
	2,7	M8 (5m)	5,5	31	44,753	1605	IRCM 93 / 132 S 4c		
	3,3	M8 (5m)	7,5	38	37,199	1819	IRCM 93 / 132 M 4b		
	3,5	M8 (5m)	7,5	41	34,034	1665	IRCM 93 / 132 M 4b		
	3,9	M8 (5m)	7,5	45	31,194	1526	IRCM 93 / 132 M 4b		
	0,9	M7 (4m)	1,5	10	133,509	1306	IRCM 83 / 90 L 4a		
	1,0	M7 (4m)	2,2	12	121,711	1746	IRCM 83 / 100 L 4a		
	1,2	M6 (3m)	2,2	14	102,407	1469	IRCM 83 / 100 L 4a		
	1,3	M6 (3m)	3	15	92,330	1806	IRCM 83 / 100 L 4b		
	1,6	M6 (3m)	3	19	75,613	1479	IRCM 83 / 100 L 4b		
	2,0	M6 (3m)	4	23	60,299	1573	IRCM 83 / 112 M 4b		
	2,2	M6 (3m)	4	26	54,358	1418	IRCM 83 / 112 M 4b		
2,5	M6 (3m)	5,5	29	48,314	1733	IRCM 83 / 132 S 4c			
3,0	M6 (3m)	5,5	35	39,796	1427	IRCM 83 / 132 S 4c			
3,6	M6 (3m)	7,5	42	33,003	1614	IRCM 83 / 132 M 4b			
4,4	M6 (3m)	9,2	51	27,535	1652	IRCM 83 / 132 M 4c			





D _T Tambur Çapı Drum Diameter <i>Diamètre de l'arbre</i> [mm]	V _h Kaldırma Hızı Lifting Speeds <i>Vitesse de levage</i> [m/min]	Vinç Sınıfı Crane Class <i>Classification de l'application de levage</i> ISO (FEM)	P ₁ Motor Gücü Power <i>Puissance</i> [kW]	n ₂ Çıkış Devri Output Speeds <i>Vitesse de sortie</i> [r.p.m]	i Tahvil Ratio <i>Rapport de réduction</i>	M ₂ Çıkış Momenti Output Torque <i>Couple de sortie</i>	Tip Type <i>Typ</i>		 kg
Ø230	0,8	M8 (5m)	1,5	8,6	162,826	1593	IRCM 93 / 90 L 4a		
	0,9	M8 (5m)	1,5	9,5	146,946	1437	IRCM 93 / 90 L 4a		
	0,9	M8 (5m)	2,2	10	133,419	1914	IRCM 93 / 100 L 4a		
	1,2	M8 (5m)	2,2	13	111,602	1601	IRCM 93 / 100 L 4a		
	1,4	M8 (5m)	3	16	87,936	1720	IRCM 93 / 100 L 4b		
	1,6	M8 (5m)	3	18	79,841	1562	IRCM 93 / 100 L 4b		
	1,9	M8 (5m)	4	21	66,785	1742	IRCM 93 / 112 M 4b		
	2,1	M8 (5m)	4	23	61,444	1603	IRCM 93 / 112 M 4b		
	2,3	M8 (5m)	5,5	26	54,545	1956	IRCM 93 / 132 S 4c		
	2,8	M8 (5m)	5,5	31	44,753	1605	IRCM 93 / 132 S 4c		
	3,4	M8 (5m)	7,5	38	37,199	1819	IRCM 93 / 132 M 4b		
	3,7	M8 (5m)	7,5	41	34,034	1665	IRCM 93 / 132 M 4b		
	4,1	M8 (5m)	7,5	45	31,194	1526	IRCM 93 / 132 M 4b		
	0,9	M6 (3m)	2,2	10	133,509	1915	IRCM 83 / 100 L 4a		
	1,1	M6 (3m)	2,2	12	121,711	1746	IRCM 83 / 100 L 4a		
	1,3	M6 (3m)	2,2	14	102,407	1469	IRCM 83 / 100 L 4a		
	1,4	M6 (3m)	3	15	92,330	1806	IRCM 83 / 100 L 4b		
	1,7	M6 (3m)	3	19	75,613	1479	IRCM 83 / 100 L 4b		
	2,1	M6 (3m)	4	23	60,299	1573	IRCM 83 / 112 M 4b		
	2,3	M6 (3m)	5,5	26	54,358	1950	IRCM 83 / 132 S 4c		
	2,6	M6 (3m)	5,5	29	48,314	1733	IRCM 83 / 132 S 4c		
	3,2	M6 (3m)	5,5	35	39,796	1427	IRCM 83 / 132 S 4c		
3,8	M6 (3m)	7,5	42	33,003	1614	IRCM 83 / 132 M 4b			
4,6	M5 (2m)	9,2	51	27,535	1652	IRCM 83 / 132 M 4c			
Ø240	0,8	M8 (5m)	1,5	8,6	162,826	1593	IRCM 93 / 90 L 4a		
	0,9	M8 (5m)	2,2	9,5	146,946	2108	IRCM 93 / 100 L 4a		
	0,9	M8 (5m)	2,2	10	133,419	1914	IRCM 93 / 100 L 4a		
	1,2	M8 (5m)	2,2	13	111,602	1601	IRCM 93 / 100 L 4a		
	1,5	M8 (5m)	3	16	87,936	1720	IRCM 93 / 100 L 4b		
	1,7	M8 (5m)	3	18	79,841	1562	IRCM 93 / 100 L 4b		
	2,0	M8 (5m)	4	21	66,785	1742	IRCM 93 / 112 M 4b		
	2,2	M8 (5m)	4	23	61,444	1603	IRCM 93 / 112 M 4b		
	2,4	M8 (5m)	5,5	26	54,545	1956	IRCM 93 / 132 S 4c		
	2,9	M8 (5m)	5,5	31	44,753	1605	IRCM 93 / 132 S 4c		
	3,6	M8 (5m)	7,5	38	37,199	1819	IRCM 93 / 132 M 4b		
	3,9	M8 (5m)	7,5	41	34,034	1665	IRCM 93 / 132 M 4b		
	4,2	M8 (5m)	7,5	45	31,194	1526	IRCM 93 / 132 M 4b		



Vinç sistemleri kaldırma redüktörleri güç ve devir tabloları / Power and ratio table for hoisting applications / Tableau de classification des couples et rapports de réduction pour les applications de levage



D _T Tambur Çapı Drum Diameter <i>Diamètre de l'arbre</i> [mm]	V _h Kaldırma Hızı Lifting Speeds <i>Vitesse de levage</i> [m/min]	Vinç Sınıfı Crane Class <i>Classification de l'application de levage</i> ISO (FEM)	P ₁ Motor Gücü Power <i>Puissance</i> [kW]	n ₂ Çıkış Devri Output Speeds <i>Vitesse de sortie</i> [r.p.m]	i Tahvil Ratio <i>Rapport de réduction</i>	M ₂ Çıkış Momenti Output Torque <i>Couple de sortie</i>	Tip Type <i>Typ</i>		 kg
Ø320	3,6	M6 (3m)	9,2	7,1	198,333	11899	IRCM 123 / 132 M 4c		
	4,4	M6 (3m)	11	8,7	161,000	11549	IRCM 123 / 160 M 4b		
	5,0	M6 (3m)	11	10	134,473	9646	IRCM 123 / 160 M 4b		
	6,0	M6 (3m)	15	12	118,333	11575	IRCM 123 / 160 L 4a		
	6,5	M6 (3m)	15	13	105,000	10271	IRCM 123 / 160 L 4a		
	7,5	M6 (3m)	18,5	15	93,800	11316	IRCM 123 / 180 M 4b		
	8,5	M6 (3m)	18,5	17	84,259	10165	IRCM 123 / 180 M 4b		
	9,5	M6 (3m)	22	19	73,179	10499	IRCM 123 / 180 L 4b		
	11	M6 (3m)	30	22	64,396	12598	IRCM 123 / 200 L 4c		
	13	M6 (3m)	30	25	57,140	11179	IRCM 123 / 200 L 4c		
	14	M6 (3m)	30	27	51,045	9986	IRCM 123 / 200 L 4c		
	16	M6 (3m)	37	31	45,853	11064	IRCM 123 / 225 S 4a		
	3,5	M4 (1Am)	9,2	7,0	199,476	11968	IRCM 103 / 132 M 4c		
	4,0	M4 (1Am)	9,2	7,9	177,284	10636	IRCM 103 / 132 M 4c		
	4,9	M4 (1Am)	11	10	143,552	10298	IRCM 103 / 160 M 4b		
	6,0	M4 (1Am)	15	12	119,126	11653	IRCM 103 / 160 L 4a		
	6,5	M4 (1Am)	15	13	109,276	10689	IRCM 103 / 160 L 4a		
	7,5	M4 (1Am)	18,5	15	95,896	11569	IRCM 103 / 180 M 4b		
	9,0	M4 (1Am)	22	18	78,692	11290	IRCM 103 / 180 L 4b		
	9,5	M4 (1Am)	22	19	71,869	10311	IRCM 103 / 180 L 4b		
12,1	M4 (1Am)	30	24	58,778	11499	IRCM 103 / 200 L 4c			
13,6	M3 (1Bm)	30	27	51,907	10155	IRCM 103 / 200 L 4c			
Ø340	3,8	M6 (3m)	9,2	7,1	198,333	11899	IRCM 123 / 132 M 4c		
	4,6	M6 (3m)	11	8,7	161,000	11549	IRCM 123 / 160 M 4b		
	5,3	M6 (3m)	15	10	134,473	13154	IRCM 123 / 160 L 4a		
	6,4	M6 (3m)	15	12	118,333	11575	IRCM 123 / 160 L 4a		
	6,9	M6 (3m)	15	13	105,000	10271	IRCM 123 / 160 L 4a		
	8,0	M6 (3m)	18,5	15	93,800	11316	IRCM 123 / 180 M 4b		
	9,1	M6 (3m)	22	17	84,259	12088	IRCM 123 / 180 L 4b		
	10	M6 (3m)	22	19	73,179	10499	IRCM 123 / 180 L 4b		
	12	M6 (3m)	30	22	64,396	12598	IRCM 123 / 200 L 4c		
	13	M6 (3m)	30	25	57,140	11179	IRCM 123 / 200 L 4c		
	14	M6 (3m)	37	27	51,045	12317	IRCM 123 / 225 S 4a		
	17	M6 (3m)	37	31	45,853	11064	IRCM 123 / 225 S 4a		
	3,7	M4 (1Am)	9,2	7,0	199,476	11968	IRCM 103 / 132 M 4c		
	4,2	M4 (1Am)	9,2	7,9	177,284	10636	IRCM 103 / 132 M 4c		
	5,2	M4 (1Am)	15	10	143,552	14042	IRCM 103 / 160 L 4a		
	6,4	M4 (1Am)	15	12	119,126	11653	IRCM 103 / 160 L 4a		
	6,9	M4 (1Am)	15	13	109,276	10689	IRCM 103 / 160 L 4a		
	8,0	M4 (1Am)	18,5	15	95,896	11569	IRCM 103 / 180 M 4b		
	9,6	M4 (1Am)	22	18	78,692	11290	IRCM 103 / 180 L 4b		
	10,1	M4 (1Am)	22	19	71,869	10311	IRCM 103 / 180 L 4b		
12,8	M3 (1Bm)	30	24	58,778	11499	IRCM 103 / 200 L 4c			
14,4	M3 (1Bm)	37	27	51,907	12525	IRCM 103 / 225 S 4a			
Ø360	4,0	M6 (3m)	9,2	7,1	198,333	11899	IRCM 123 / 132 M 4c		
	4,9	M6 (3m)	11	8,7	161,000	11549	IRCM 123 / 160 M 4b		
	5,7	M6 (3m)	15	10	134,473	13154	IRCM 123 / 160 L 4a		
	6,8	M6 (3m)	15	12	118,333	11575	IRCM 123 / 160 L 4a		
	7,3	M6 (3m)	18,5	13	105,000	12668	IRCM 123 / 180 M 4b		
	8,5	M6 (3m)	18,5	15	93,800	11316	IRCM 123 / 180 M 4b		
	9,6	M6 (3m)	22	17	84,259	12088	IRCM 123 / 180 L 4b		
	10,7	M6 (3m)	30	19	73,179	14317	IRCM 123 / 200 L 4c		
	12,4	M6 (3m)	30	22	64,396	12598	IRCM 123 / 200 L 4c		
	14,1	M6 (3m)	37	25	57,140	13787	IRCM 123 / 225 S 4a		
	15,3	M6 (3m)	37	27	51,045	12317	IRCM 123 / 225 S 4a		
	17,5	M5 (2m)	45	31	45,853	13456	IRCM 123 / 225 M 4c		



D _T Tambur Çapı Drum Diameter <i>Diamètre de l'arbre</i> [mm]	V _h Kaldırma Hızı Lifting Speeds <i>Vitesse de levage</i> [m/min]	Vinç Sınıfı Crane Class <i>Classification de l'application de levage</i> ISO (FEM)	P ₁ Motor Gücü Power <i>Puissance</i> [kW]	n ₂ Çıkış Devri Output Speeds <i>Vitesse de sortie</i> [r.p.m]	i Tahvil Ratio <i>Rapport de réduction</i>	M ₂ Çıkış Momenti Output Torque <i>Couple de sortie</i>	Tip Type <i>Typ</i>		 kg
Ø380	4,2	M6 (3m)	9,2	7,1	198,333	11899	IRCM 123 / 132 M 4c		
	5,2	M5 (2m)	15	8,7	161,000	15749	IRCM 123 / 160 L 4a		
	6,0	M5 (2m)	15	10	134,473	13154	IRCM 123 / 160 L 4a		
	7,2	M5 (2m)	18,5	12	118,333	14276	IRCM 123 / 180 M 4b		
	7,8	M5 (2m)	18,5	13	105,000	12668	IRCM 123 / 180 M 4b		
	8,9	M5 (2m)	22	15	93,800	13457	IRCM 123 / 180 L 4b		
	10,1	M5 (2m)	22	17	84,259	12088	IRCM 123 / 180 L 4b		
	11,3	M5 (2m)	30	19	73,179	14317	IRCM 123 / 200 L 4c		
	13,1	M5 (2m)	30	22	64,396	12598	IRCM 123 / 200 L 4c		
	14,9	M5 (2m)	37	25	57,140	13787	IRCM 123 / 225 S 4a		
	16,1	M5 (2m)	37	27	51,045	12317	IRCM 123 / 225 S 4a		
18,5	M5 (2m)	45	31	45,853	13456	IRCM 123 / 225 M 4c			
Ø400	4,5	M5 (2m)	11	7,1	198,333	14227	IRCM 123 / 160 M 4b		
	5,5	M5 (2m)	15	8,7	161,000	15749	IRCM 123 / 160 L 4a		
	6,3	M5 (2m)	15	10	134,473	13154	IRCM 123 / 160 L 4a		
	7,5	M5 (2m)	18,5	12	118,333	14276	IRCM 123 / 180 M 4b		
	8,2	M5 (2m)	18,5	13	105,000	12668	IRCM 123 / 180 M 4b		
	9,4	M5 (2m)	22	15	93,800	13457	IRCM 123 / 180 L 4b		
	10,7	M5 (2m)	30	17	84,259	16484	IRCM 123 / 200 L 4c		
	11,9	M5 (2m)	30	19	73,179	14317	IRCM 123 / 200 L 4c		
	13,8	M5 (2m)	30	22	64,396	12598	IRCM 123 / 200 L 4c		
	15,7	M5 (2m)	37	25	57,140	13787	IRCM 123 / 225 S 4a		
	17,0	M5 (2m)	37	27	51,045	12317	IRCM 123 / 225 S 4a		
19,5	M4 (1Am)	45	31	45,853	13456	IRCM 123 / 225 M 4c			
Ø420	4,7	M5 (2m)	11	7,1	198,333	14227	IRCM 123 / 160 M 4b		
	5,7	M5 (2m)	15	8,7	161,000	15749	IRCM 123 / 160 L 4a		
	6,6	M4 (1Am)	15	10	134,473	13154	IRCM 123 / 160 L 4a		
	7,9	M4 (1Am)	18,5	12	118,333	14276	IRCM 123 / 180 M 4b		
	8,6	M4 (1Am)	18,5	13	105,000	12668	IRCM 123 / 180 M 4b		
	9,9	M4 (1Am)	22	15	93,800	13457	IRCM 123 / 180 L 4b		
	11,2	M4 (1Am)	30	17	84,259	16484	IRCM 123 / 200 L 4c		
	12,5	M4 (1Am)	30	19	73,179	14317	IRCM 123 / 200 L 4c		
	14,5	M4 (1Am)	37	22	64,396	15538	IRCM 123 / 225 S 4a		
	16,5	M4 (1Am)	37	25	57,140	13787	IRCM 123 / 225 S 4a		
	17,8	M4 (1Am)	45	27	51,045	14980	IRCM 123 / 225 M 4c		
20,4	M4 (1Am)	45	31	45,853	13456	IRCM 123 / 225 M 4c			
Ø440	4,9	M4 (1Am)	11	7,1	198,333	14227	IRCM 123 / 160 M 4b		
	6,0	M4 (1Am)	15	8,7	161,000	15749	IRCM 123 / 160 L 4a		
	6,9	M4 (1Am)	15	10	134,473	13154	IRCM 123 / 160 L 4a		
	8,3	M4 (1Am)	18,5	12	118,333	14276	IRCM 123 / 180 M 4b		
	9,0	M4 (1Am)	22	13	105,000	15064	IRCM 123 / 180 L 4b		
	10,4	M4 (1Am)	30	15	93,800	18351	IRCM 123 / 200 L 4c		
	11,7	M4 (1Am)	30	17	84,259	16484	IRCM 123 / 200 L 4c		
	13,1	M4 (1Am)	30	19	73,179	14317	IRCM 123 / 200 L 4c		
	15,2	M4 (1Am)	37	22	64,396	15538	IRCM 123 / 225 S 4a		
	17,3	M4 (1Am)	45	25	57,140	16768	IRCM 123 / 225 M 4c		
	18,7	M4 (1Am)	45	27	51,045	14980	IRCM 123 / 225 M 4c		
21,4	M4 (1Am)	55	31	45,853	16446	IRCM 123 / 250 M 4c			





Vinç sistemleri kaldırma redüktörleri güç ve devir tabloları / Power and ratio table for hoisting applications / Tableau de classification des couples et rapports de réduction pour les applications de levage

D _T Tambur Çapı Drum Diameter <i>Diamètre de l'arbre</i> [mm]	V _h Kaldırma Hızı Lifting Speeds <i>Vitesse de levage</i> [m/min]	Vinç Sınıfı Crane Class <i>Classification de l'application de levage</i> ISO (FEM)	P ₁ Motor Gücü Power <i>Puissance</i> [kW]	n ₂ Çıkış Devri Output Speeds <i>Vitesse de sortie</i> [r.p.m]	i Tahvil Ratio <i>Rapport de réduction</i>	M ₂ Çıkış Momenti Output Torque <i>Couple de sortie</i>	Tip Type <i>Typ</i>		 kg
Ø450	5,0	M4 (1Am)	11	7,1	198,333	14227	IRCM 123 / 160 M 4b		
	6,1	M4 (1Am)	15	8,7	161,000	15749	IRCM 123 / 160 L 4a		
	7,1	M4 (1Am)	18,5	10	134,473	16223	IRCM 123 / 180 M 4b		
	8,5	M4 (1Am)	18,5	12	118,333	14276	IRCM 123 / 180 M 4b		
	9,2	M4 (1Am)	22	13	105,000	15064	IRCM 123 / 180 L 4b		
	10,6	M4 (1Am)	30	15	93,800	18351	IRCM 123 / 200 L 4c		
	12,0	M4 (1Am)	30	17	84,259	16484	IRCM 123 / 200 L 4c		
	13,4	M4 (1Am)	30	19	73,179	14317	IRCM 123 / 200 L 4c		
	15,5	M4 (1Am)	37	22	64,396	15538	IRCM 123 / 225 S 4a		
	17,7	M4 (1Am)	45	25	57,140	16768	IRCM 123 / 225 M 4c		
	19,1	M4 (1Am)	45	27	51,045	14980	IRCM 123 / 225 M 4c		
21,9	M4 (1Am)	55	31	45,853	16446	IRCM 123 / 250 M 4c			



D _T Tambur Çapı Drum Diameter <i>Diamètre de l'arbre</i> [mm]	V _h Kaldırma Hızı Lifting Speeds <i>Vitesse de levage</i> [m/min]	Vinç Sınıfı Crane Class <i>Classification de l'application de levage</i> ISO (FEM)	P ₁ Motor Gücü Power <i>Puissance</i> [kW]	n ₂ Çıkış Devri Output Speeds <i>Vitesse de sortie</i> [r.p.m]	i Tahvil Ratio <i>Rapport de réduction</i>	M ₂ Çıkış Momenti Output Torque <i>Couple de sortie</i>	Tip Type <i>Typ</i>			kg
Ø270	1,5	M8 (5m)	4	7,0	199,476	5203	IRCM 103 / 112 M 4b			
	1,7	M8 (5m)	4	7,9	177,284	4624	IRCM 103 / 112 M 4b			
	2,1	M8 (5m)	5,5	10	143,552	5149	IRCM 103 / 132 S 4c			
	2,5	M8 (5m)	5,5	12	119,126	4273	IRCM 103 / 132 S 4c			
	2,8	M8 (5m)	7,5	13	109,276	5345	IRCM 103 / 132 M 4b			
	3,2	M8 (5m)	7,5	15	95,896	4690	IRCM 103 / 132 M 4b			
	3,8	M8 (5m)	9,2	18	78,692	4721	IRCM 103 / 132 M 4c			
	4,0	M8 (5m)	9,2	19	71,869	4312	IRCM 103 / 132 M 4c			
	5,1	M8 (5m)	11	24	58,778	4216	IRCM 103 / 160 M 4b			
5,7	M8 (5m)	15	27	51,907	5078	IRCM 103 / 160 L 4a				
Ø280	1,5	M8 (5m)	4	7,0	199,476	5203	IRCM 103 / 112 M 4b			
	1,7	M8 (5m)	4	7,9	177,284	4624	IRCM 103 / 112 M 4b			
	2,2	M8 (5m)	5,5	10	143,552	5149	IRCM 103 / 132 S 4c			
	2,6	M8 (5m)	7,5	12	119,126	5826	IRCM 103 / 132 M 4b			
	2,9	M8 (5m)	7,5	13	109,276	5345	IRCM 103 / 132 M 4b			
	3,3	M8 (5m)	7,5	15	95,896	4690	IRCM 103 / 132 M 4b			
	4,0	M8 (5m)	9,2	18	78,692	4721	IRCM 103 / 132 M 4c			
	4,2	M8 (5m)	9,2	19	71,869	4312	IRCM 103 / 132 M 4c			
	5,3	M8 (5m)	15	24	58,778	5750	IRCM 103 / 160 L 4a			
5,9	M8 (5m)	15	27	51,907	5078	IRCM 103 / 160 L 4a				
Ø290	1,6	M8 (5m)	4	7,0	199,476	5203	IRCM 103 / 112 M 4b			
	1,8	M8 (5m)	4	7,9	177,284	4624	IRCM 103 / 112 M 4b			
	2,2	M8 (5m)	5,5	10	143,552	5149	IRCM 103 / 132 S 4c			
	2,7	M8 (5m)	7,5	12	119,126	5826	IRCM 103 / 132 M 4b			
	3,0	M8 (5m)	7,5	13	109,276	5345	IRCM 103 / 132 M 4b			
	3,4	M8 (5m)	7,5	15	95,896	4690	IRCM 103 / 132 M 4b			
	4,1	M8 (5m)	9,2	18	78,692	4721	IRCM 103 / 132 M 4c			
	4,3	M8 (5m)	11	19	71,869	5155	IRCM 103 / 160 M 4b			
	5,5	M8 (5m)	15	24	58,778	5750	IRCM 103 / 160 L 4a			
6,1	M8 (5m)	15	27	51,907	5078	IRCM 103 / 160 L 4a				
Ø300	1,6	M8 (5m)	4	7,0	199,476	5203	IRCM 103 / 112 M 4b			
	1,9	M8 (5m)	4	7,9	177,284	4624	IRCM 103 / 112 M 4b			
	2,3	M8 (5m)	5,5	10	143,552	5149	IRCM 103 / 132 S 4c			
	2,8	M8 (5m)	7,5	12	119,126	5826	IRCM 103 / 132 M 4b			
	3,1	M8 (5m)	7,5	13	109,276	5345	IRCM 103 / 132 M 4b			
	3,5	M8 (5m)	9,2	15	95,896	5753	IRCM 103 / 132 M 4c			
	4,2	M8 (5m)	9,2	18	78,692	4721	IRCM 103 / 132 M 4c			
	4,5	M8 (5m)	11	19	71,869	5155	IRCM 103 / 160 M 4b			
	5,7	M8 (5m)	15	24	58,778	5750	IRCM 103 / 160 L 4a			
6,4	M8 (5m)	15	27	51,907	5078	IRCM 103 / 160 L 4a				
Ø320	1,8	M8 (5m)	4	7,0	199,476	5203	IRCM 103 / 112 M 4b			
	2,0	M8 (5m)	5,5	7,9	177,284	6359	IRCM 103 / 132 S 4c			
	2,5	M8 (5m)	5,5	10	143,552	5149	IRCM 103 / 132 S 4c			
	3,0	M8 (5m)	7,5	12	119,126	5826	IRCM 103 / 132 M 4b			
	3,3	M8 (5m)	7,5	13	109,276	5345	IRCM 103 / 132 M 4b			
	3,8	M8 (5m)	9,2	15	95,896	5753	IRCM 103 / 132 M 4c			
	4,5	M8 (5m)	11	18	78,692	5645	IRCM 103 / 160 M 4b			
	4,8	M8 (5m)	11	19	71,869	5155	IRCM 103 / 160 M 4b			
	6,0	M8 (5m)	15	24	58,778	5750	IRCM 103 / 160 L 4a			
6,8	M7 (4m)	15	27	51,907	5078	IRCM 103 / 160 L 4a				



D _T Tambur Çapı Drum Diameter <i>Diamètre de l'arbre</i> [mm]	V _h Kaldırma Hızı Lifting Speeds <i>Vitesse de levage</i> [m/min]	Vinç Sınıfı Crane Class <i>Classification de l'application de levage</i> ISO (FEM)	P ₁ Motor Gücü Power <i>Puissance</i> [kW]	n ₂ Çıkış Devri Output Speeds <i>Vitesse de sortie</i> [r.p.m]	i Tahvil Ratio <i>Rapport de réduction</i>	M ₂ Çıkış Momenti Output Torque <i>Couple de sortie</i>	Tip Type <i>Typ</i>		 kg	
Ø330	1,8	M8 (5m)	4	7,0	199,476	5203	IRCM 103 / 112 M 4b			
	2,0	M8 (5m)	5,5	7,9	177,284	6359	IRCM 103 / 132 S 4c			
	2,5	M8 (5m)	5,5	10	143,552	5149	IRCM 103 / 132 S 4c			
	3,1	M8 (5m)	7,5	12	119,126	5826	IRCM 103 / 132 M 4b			
	3,4	M8 (5m)	7,5	13	109,276	5345	IRCM 103 / 132 M 4b			
	3,9	M8 (5m)	9,2	15	95,896	5753	IRCM 103 / 132 M 4c			
	4,7	M8 (5m)	11	18	78,692	5645	IRCM 103 / 160 M 4b			
	4,9	M8 (5m)	11	19	71,869	5155	IRCM 103 / 160 M 4b			
	6,2	M8 (5m)	15	24	58,778	5750	IRCM 103 / 160 L 4a			
Ø340	7,0	M7 (4m)	18,5	27	51,907	6262	IRCM 103 / 180 M 4b			
	1,9	M8 (5m)	5,5	7,1	198,333	7114	IRCM 123 / 132 S 4c			
	2,3	M8 (5m)	5,5	8,7	161,000	5775	IRCM 123 / 132 S 4c			
	2,7	M8 (5m)	7,5	10	134,473	6577	IRCM 123 / 132 M 4b			
	3,2	M8 (5m)	7,5	12	118,333	5788	IRCM 123 / 132 M 4b			
	3,5	M8 (5m)	7,5	13	105,000	5136	IRCM 123 / 132 M 4b			
	4,0	M8 (5m)	9,2	15	93,800	5628	IRCM 123 / 132 M 4c			
	4,5	M8 (5m)	11	17	84,259	6044	IRCM 123 / 160 M 4b			
	5,1	M8 (5m)	11	19	73,179	5249	IRCM 123 / 160 M 4b			
	5,9	M8 (5m)	15	22	64,396	6299	IRCM 123 / 160 L 4a			
	6,7	M8 (5m)	15	25	57,140	5589	IRCM 123 / 160 L 4a			
	7,2	M8 (5m)	18,5	27	51,045	6158	IRCM 123 / 180 M 4b			
	8,3	M8 (5m)	18,5	31	45,853	5532	IRCM 123 / 180 M 4b			
	Ø360	1,9	M8 (5m)	5,5	7,0	199,476	7155	IRCM 103 / 132 S 4c		
		2,1	M8 (5m)	5,5	7,9	177,284	6359	IRCM 103 / 132 S 4c		
2,6		M8 (5m)	7,5	10	143,552	7021	IRCM 103 / 132 M 4b			
3,2		M8 (5m)	7,5	12	119,126	5826	IRCM 103 / 132 M 4b			
3,5		M8 (5m)	7,5	13	109,276	5345	IRCM 103 / 132 M 4b			
4,0		M8 (5m)	9,2	15	95,896	5753	IRCM 103 / 132 M 4c			
4,8		M8 (5m)	11	18	78,692	5645	IRCM 103 / 160 M 4b			
5,1		M8 (5m)	11	19	71,869	5155	IRCM 103 / 160 M 4b			
6,4		M7 (4m)	15	24	58,778	5750	IRCM 103 / 160 L 4a			
7,2		M7 (4m)	18,5	27	51,907	6262	IRCM 103 / 180 M 4b			
2,0		M8 (5m)	5,5	7,1	198,333	7114	IRCM 123 / 132 S 4c			
2,5		M8 (5m)	5,5	8,7	161,000	5775	IRCM 123 / 132 S 4c			
2,8		M8 (5m)	7,5	10	134,473	6577	IRCM 123 / 132 M 4b			
3,4		M8 (5m)	7,5	12	118,333	5788	IRCM 123 / 132 M 4b			
3,7		M8 (5m)	9,2	13	105,000	6300	IRCM 123 / 132 M 4c			
4,2	M8 (5m)	9,2	15	93,800	5628	IRCM 123 / 132 M 4c				
4,8	M8 (5m)	11	17	84,259	6044	IRCM 123 / 160 M 4b				
5,4	M8 (5m)	15	19	73,179	7158	IRCM 123 / 160 L 4a				
6,2	M8 (5m)	15	22	64,396	6299	IRCM 123 / 160 L 4a				
7,1	M8 (5m)	18,5	25	57,140	6894	IRCM 123 / 180 M 4b				
7,6	M8 (5m)	18,5	27	51,045	6158	IRCM 123 / 180 M 4b				
8,8	M8 (5m)	22	31	45,853	6578	IRCM 123 / 180 L 4b				
Ø360	2,0	M7 (4m)	5,5	7,0	199,476	7155	IRCM 103 / 132 S 4c			
	2,2	M7 (4m)	5,5	7,9	177,284	6359	IRCM 103 / 132 S 4c			
	2,8	M7 (4m)	7,5	10	143,552	7021	IRCM 103 / 132 M 4b			
	3,4	M7 (4m)	7,5	12	119,126	5826	IRCM 103 / 132 M 4b			
	3,7	M7 (4m)	9,2	13	109,276	6556	IRCM 103 / 132 M 4c			
	4,2	M7 (4m)	9,2	15	95,896	5753	IRCM 103 / 132 M 4c			
	5,1	M7 (4m)	11	18	78,692	5645	IRCM 103 / 160 M 4b			
	5,4	M7 (4m)	15	19	71,869	7030	IRCM 103 / 160 L 4a			
	6,8	M7 (4m)	15	24	58,778	5750	IRCM 103 / 160 L 4a			
	7,6	M7 (4m)	18,5	27	51,907	6262	IRCM 103 / 180 M 4b			



D _T Tambur Çapı Drum Diameter <i>Diamètre de l'arbre</i> [mm]	V _h Kaldırma Hızı Lifting Speeds <i>Vitesse de levage</i> [m/min]	Vinç Sınıfı Crane Class <i>Classification de l'application de levage</i> ISO (FEM)	P ₁ Motor Gücü Power <i>Puissance</i> [kW]	n ₂ Çıkış Devri Output Speeds <i>Vitesse de sortie</i> [r.p.m]	i Tahvil Ratio <i>Rapport de réduction</i>	M ₂ Çıkış Momenti Output Torque <i>Couple de sortie</i>	Tip Type <i>Typ</i>		 kg
Ø380	2,1	M8 (5m)	5,5	7,1	198,333	7114	IRCM 123 / 132 S 4c		
	2,6	M8 (5m)	7,5	8,7	161,000	7874	IRCM 123 / 132 M 4b		
	3,0	M8 (5m)	7,5	10	134,473	6577	IRCM 123 / 132 M 4b		
	3,6	M8 (5m)	9,2	12	118,333	7099	IRCM 123 / 132 M 4c		
	3,9	M8 (5m)	9,2	13	105,000	6300	IRCM 123 / 132 M 4c		
	4,5	M8 (5m)	11	15	93,800	6729	IRCM 123 / 160 M 4b		
	5,1	M8 (5m)	11	17	84,259	6044	IRCM 123 / 160 M 4b		
	5,7	M8 (5m)	15	19	73,179	7158	IRCM 123 / 160 L 4a		
	6,6	M8 (5m)	15	22	64,396	6299	IRCM 123 / 160 L 4a		
	7,5	M8 (5m)	18,5	25	57,140	6894	IRCM 123 / 180 M 4b		
	8,1	M8 (5m)	18,5	27	51,045	6158	IRCM 123 / 180 M 4b		
	9,2	M8 (5m)	22	31	45,853	6578	IRCM 123 / 180 L 4b		
	2,1	M7 (4m)	5,5	7,0	199,476	7155	IRCM 103 / 132 S 4c		
	2,4	M7 (4m)	5,5	7,9	177,284	6359	IRCM 103 / 132 S 4c		
	2,9	M7 (4m)	7,5	10	143,552	7021	IRCM 103 / 132 M 4b		
	3,6	M7 (4m)	9,2	12	119,126	7147	IRCM 103 / 132 M 4c		
	3,9	M7 (4m)	9,2	13	109,276	6556	IRCM 103 / 132 M 4c		
	4,5	M7 (4m)	11	15	95,896	6879	IRCM 103 / 160 M 4b		
	5,4	M7 (4m)	15	18	78,692	7698	IRCM 103 / 160 L 4a		
	5,7	M7 (4m)	15	19	71,869	7030	IRCM 103 / 160 L 4a		
7,2	M7 (4m)	18,5	24	58,778	7091	IRCM 103 / 180 M 4b			
8,1	M7 (4m)	18,5	27	51,907	6262	IRCM 103 / 180 M 4b			



Vinç sistemleri kaldırma redüktörleri güç ve devir tabloları / Power and ratio table for hoisting applications / Tableau de classification des couples et rapports de réduction pour les applications de levage



D _T Tambur Çapı Drum Diameter <i>Diamètre de l'arbre</i> [mm]	V _h Kaldırma Hızı Lifting Speeds <i>Vitesse de levage</i> [m/min]	Vinç Sınıfı Crane Class <i>Classification de l'application de levage</i> ISO (FEM)	P ₁ Motor Gücü Power <i>Puissance</i> [kW]	n ₂ Çıkış Devri Output Speeds <i>Vitesse de sortie</i> [r.p.m]	i Tahvil Ratio <i>Rapport de réduction</i>	M ₂ Çıkış Momenti Output Torque <i>Couple de sortie</i>	Tip Type <i>Typ</i>		 kg
Ø230	0,8	M8 (5m)	2,2	7,0	199,476	2862	IRCM 103 / 100 L 4a		
	1,0	M8 (5m)	2,2	7,9	177,284	2543	IRCM 103 / 100 L 4a		
	1,2	M8 (5m)	3	10	143,552	2808	IRCM 103 / 100 L 4b		
	1,4	M8 (5m)	4	12	119,126	3107	IRCM 103 / 112 M 4b		
	1,6	M8 (5m)	4	13	109,276	2850	IRCM 103 / 112 M 4b		
	1,8	M8 (5m)	4	15	95,896	2501	IRCM 103 / 112 M 4b		
	2,2	M8 (5m)	5,5	18	78,692	2822	IRCM 103 / 132 S 4c		
	2,3	M8 (5m)	5,5	19	71,869	2578	IRCM 103 / 132 S 4c		
	2,9	M8 (5m)	7,5	24	58,778	2875	IRCM 103 / 132 M 4b		
	3,2	M8 (5m)	7,5	27	51,907	2539	IRCM 103 / 132 M 4b		
	1,0	M8 (5m)	3	8,6	162,826	3186	IRCM 93 / 100 L 4b		
	1,1	M8 (5m)	3	9,5	146,946	2875	IRCM 93 / 100 L 4b		
	1,2	M8 (5m)	3	10	133,419	2610	IRCM 93 / 100 L 4b		
	1,6	M8 (5m)	4	13	111,602	2911	IRCM 93 / 112 M 4b		
	1,9	M8 (5m)	5,5	16	87,936	3154	IRCM 93 / 132 S 4c		
	2,2	M7 (4m)	5,5	18	79,841	2864	IRCM 93 / 132 S 4c		
	2,5	M7 (4m)	5,5	21	66,785	2395	IRCM 93 / 132 S 4c		
	2,8	M7 (4m)	7,5	23	61,444	3005	IRCM 93 / 132 M 4b		
	3,1	M7 (4m)	7,5	26	54,545	2668	IRCM 93 / 132 M 4b		
	3,7	M7 (4m)	9,2	31	44,753	2685	IRCM 93 / 132 M 4c		
4,6	M7 (4m)	11	38	37,199	2668	IRCM 93 / 160 M 4b			
4,9	M7 (4m)	11	41	34,034	2441	IRCM 93 / 160 M 4b			
5,4	M7 (4m)	15	45	31,194	3051	IRCM 93 / 160 L 4a			
Ø240	0,9	M8 (5m)	2,2	7,0	199,476	2862	IRCM 103 / 100 L 4a		
	1,0	M8 (5m)	2,2	7,9	177,284	2543	IRCM 103 / 100 L 4a		
	1,2	M8 (5m)	3	10	143,552	2808	IRCM 103 / 100 L 4b		
	1,5	M8 (5m)	4	12	119,126	3107	IRCM 103 / 112 M 4b		
	1,6	M8 (5m)	4	13	109,276	2850	IRCM 103 / 112 M 4b		
	1,9	M8 (5m)	5,5	15	95,896	3440	IRCM 103 / 132 S 4c		
	2,3	M8 (5m)	5,5	18	78,692	2822	IRCM 103 / 132 S 4c		
	2,4	M8 (5m)	5,5	19	71,869	2578	IRCM 103 / 132 S 4c		
	3,0	M8 (5m)	7,5	24	58,778	2875	IRCM 103 / 132 M 4b		
	3,4	M8 (5m)	7,5	27	51,907	2539	IRCM 103 / 132 M 4b		
	1,1	M8 (5m)	3	8,6	162,826	3186	IRCM 93 / 100 L 4b		
	1,2	M8 (5m)	3	9,5	146,946	2875	IRCM 93 / 100 L 4b		
	1,3	M8 (5m)	3	10	133,419	2610	IRCM 93 / 100 L 4b		
	1,6	M8 (5m)	4	13	111,602	2911	IRCM 93 / 112 M 4b		
	2,0	M7 (4m)	5,5	16	87,936	3154	IRCM 93 / 132 S 4c		
	2,3	M7 (4m)	5,5	18	79,841	2864	IRCM 93 / 132 S 4c		
	2,6	M7 (4m)	7,5	21	66,785	3266	IRCM 93 / 132 M 4b		
	2,9	M7 (4m)	7,5	23	61,444	3005	IRCM 93 / 132 M 4b		
	3,3	M7 (4m)	7,5	26	54,545	2668	IRCM 93 / 132 M 4b		
	3,9	M7 (4m)	9,2	31	44,753	2685	IRCM 93 / 132 M 4c		
4,8	M7 (4m)	11	38	37,199	2668	IRCM 93 / 160 M 4b			
5,1	M7 (4m)	15	41	34,034	3329	IRCM 93 / 160 L 4a			
5,7	M7 (4m)	15	45	31,194	3051	IRCM 93 / 160 L 4a			
	0,9	M8 (5m)	2,2	7,0	199,476	2862	IRCM 103 / 100 L 4a		
	1,0	M8 (5m)	3	7,9	177,284	3468	IRCM 103 / 100 L 4b		
	1,3	M8 (5m)	3	10	143,552	2808	IRCM 103 / 100 L 4b		
	1,6	M8 (5m)	4	12	119,126	3107	IRCM 103 / 112 M 4b		
	1,7	M8 (5m)	4	13	109,276	2850	IRCM 103 / 112 M 4b		
	2,0	M8 (5m)	5,5	15	95,896	3440	IRCM 103 / 132 S 4c		
	2,4	M8 (5m)	5,5	18	78,692	2822	IRCM 103 / 132 S 4c		
	2,5	M8 (5m)	5,5	19	71,869	2578	IRCM 103 / 132 S 4c		
	3,1	M8 (5m)	7,5	24	58,778	2875	IRCM 103 / 132 M 4b		
	3,5	M8 (5m)	9,2	27	51,907	3114	IRCM 103 / 132 M 4c		



D _T Tambur Çapı Drum Diameter <i>Diamètre de l'arbre</i> [mm]	V _h Kaldırma Hızı Lifting Speeds <i>Vitesse de levage</i> [m/min]	Vinç Sınıfı Crane Class <i>Classification de l'application de levage</i> ISO (FEM)	P ₁ Motor Gücü Power <i>Puissance</i> [kW]	n ₂ Çıkış Devri Output Speeds <i>Vitesse de sortie</i> [r.p.m]	i Tahvil Ratio <i>Rapport de réduction</i>	M ₂ Çıkış Momenti Output Torque <i>Couple de sortie</i>	Tip Type <i>Typ</i>			kg
Ø250	1,1	M8 (5m)	3	8,6	162,826	3186	IRCM 93 / 100 L 4b			
	1,2	M8 (5m)	3	9,5	146,946	2875	IRCM 93 / 100 L 4b			
	1,3	M7 (4m)	3	10	133,419	2610	IRCM 93 / 100 L 4b			
	1,7	M7 (4m)	4	13	111,602	2911	IRCM 93 / 112 M 4b			
	2,1	M7 (4m)	5,5	16	87,936	3154	IRCM 93 / 132 S 4c			
	2,4	M7 (4m)	5,5	18	79,841	2864	IRCM 93 / 132 S 4c			
	2,7	M7 (4m)	7,5	21	66,785	3266	IRCM 93 / 132 M 4b			
	3,0	M7 (4m)	7,5	23	61,444	3005	IRCM 93 / 132 M 4b			
	3,4	M7 (4m)	7,5	26	54,545	2668	IRCM 93 / 132 M 4b			
	4,1	M7 (4m)	9,2	31	44,753	2685	IRCM 93 / 132 M 4c			
	5,0	M6 (3m)	11	38	37,199	2668	IRCM 93 / 160 M 4b			
	5,4	M6 (3m)	15	41	34,034	3329	IRCM 93 / 160 L 4a			
	5,9	M6 (3m)	15	45	31,194	3051	IRCM 93 / 160 L 4a			
Ø260	1,0	M8 (5m)	2,2	7,0	199,476	2862	IRCM 103 / 100 L 4a			
	1,1	M8 (5m)	3	7,9	177,284	3468	IRCM 103 / 100 L 4b			
	1,3	M8 (5m)	3	10	143,552	2808	IRCM 103 / 100 L 4b			
	1,6	M8 (5m)	4	12	119,126	3107	IRCM 103 / 112 M 4b			
	1,8	M8 (5m)	4	13	109,276	2850	IRCM 103 / 112 M 4b			
	2,0	M8 (5m)	5,5	15	95,896	3440	IRCM 103 / 132 S 4c			
	2,4	M8 (5m)	5,5	18	78,692	2822	IRCM 103 / 132 S 4c			
	2,6	M8 (5m)	7,5	19	71,869	3515	IRCM 103 / 132 M 4b			
	3,3	M8 (5m)	7,5	24	58,778	2875	IRCM 103 / 132 M 4b			
	3,7	M8 (5m)	9,2	27	51,907	3114	IRCM 103 / 132 M 4c			
	1,2	M7 (4m)	3	8,6	162,826	3186	IRCM 93 / 100 L 4b			
	1,3	M7 (4m)	3	9,5	146,946	2875	IRCM 93 / 100 L 4b			
	1,4	M7 (4m)	3	10	133,419	2610	IRCM 93 / 100 L 4b			
	1,8	M7 (4m)	4	13	111,602	2911	IRCM 93 / 112 M 4b			
	2,2	M7 (4m)	5,5	16	87,936	3154	IRCM 93 / 132 S 4c			
	2,4	M7 (4m)	5,5	18	79,841	2864	IRCM 93 / 132 S 4c			
	2,9	M7 (4m)	7,5	21	66,785	3266	IRCM 93 / 132 M 4b			
	3,1	M7 (4m)	7,5	23	61,444	3005	IRCM 93 / 132 M 4b			
	3,5	M7 (4m)	9,2	26	54,545	3272	IRCM 93 / 132 M 4c			
	4,2	M6 (3m)	9,2	31	44,753	2685	IRCM 93 / 132 M 4c			
	5,2	M6 (3m)	15	38	37,199	3639	IRCM 93 / 160 L 4a			
	5,6	M6 (3m)	15	41	34,034	3329	IRCM 93 / 160 L 4a			
	6,1	M6 (3m)	15	45	31,194	3051	IRCM 93 / 160 L 4a			
1,0	M8 (5m)	2,2	7,0	199,476	2862	IRCM 103 / 100 L 4a				
1,1	M8 (5m)	3	7,9	177,284	3468	IRCM 103 / 100 L 4b				
1,4	M8 (5m)	3	10	143,552	2808	IRCM 103 / 100 L 4b				
1,7	M8 (5m)	4	12	119,126	3107	IRCM 103 / 112 M 4b				
1,8	M8 (5m)	4	13	109,276	2850	IRCM 103 / 112 M 4b				
2,1	M8 (5m)	5,5	15	95,896	3440	IRCM 103 / 132 S 4c				
2,5	M8 (5m)	5,5	18	78,692	2822	IRCM 103 / 132 S 4c				
2,7	M8 (5m)	7,5	19	71,869	3515	IRCM 103 / 132 M 4b				
3,4	M8 (5m)	7,5	24	58,778	2875	IRCM 103 / 132 M 4b				
3,8	M8 (5m)	9,2	27	51,907	3114	IRCM 103 / 132 M 4c				



Vinç sistemleri kaldırma redükörleri güç ve devir tabloları / Power and ratio table for hoisting applications / Tableau de classification des couples et rapports de réduction pour les applications de levage



D _T Tambur Çapı Drum Diameter <i>Diamètre de l'arbre</i> [mm]	V _h Kaldırma Hızı Lifting Speeds <i>Vitesse de levage</i> [m/min]	Vinç Sınıfı Crane Class <i>Classification de l'application de levage</i> ISO (FEM)	P ₁ Motor Gücü Power <i>Puissance</i> [kW]	n ₂ Çıkış Devri Output Speeds <i>Vitesse de sortie</i> [r.p.m]	i Tahvil Ratio <i>Rapport de réduction</i>	M ₂ Çıkış Momenti Output Torque <i>Couple de sortie</i>	Tip Type <i>Typ</i>		 kg
Ø270	1,2	M7 (4m)	3	8,6	162,826	3186	IRCM 93 / 100 L 4b		
	1,3	M7 (4m)	3	9,5	146,946	2875	IRCM 93 / 100 L 4b		
	1,4	M7 (4m)	4	10	133,419	3480	IRCM 93 / 112 M 4b		
	1,8	M7 (4m)	4	13	111,602	2911	IRCM 93 / 112 M 4b		
	2,3	M7 (4m)	5,5	16	87,936	3154	IRCM 93 / 132 S 4c		
	2,5	M7 (4m)	5,5	18	79,841	2864	IRCM 93 / 132 S 4c		
	3,0	M7 (4m)	7,5	21	66,785	3266	IRCM 93 / 132 M 4b		
	3,2	M7 (4m)	7,5	23	61,444	3005	IRCM 93 / 132 M 4b		
	3,7	M6 (3m)	9,2	26	54,545	3272	IRCM 93 / 132 M 4c		
	4,4	M6 (3m)	11	31	44,753	3210	IRCM 93 / 160 M 4b		
	5,4	M6 (3m)	15	38	37,199	3639	IRCM 93 / 160 L 4a		
	5,8	M6 (3m)	15	41	34,034	3329	IRCM 93 / 160 L 4a		
6,4	M6 (3m)	15	45	31,194	3051	IRCM 93 / 160 L 4a			
Ø280	1,0	M8 (5m)	3	7,0	199,476	3903	IRCM 103 / 100 L 4b		
	1,2	M8 (5m)	3	7,9	177,284	3468	IRCM 103 / 100 L 4b		
	1,4	M8 (5m)	4	10	143,552	3745	IRCM 103 / 112 M 4b		
	1,8	M8 (5m)	4	12	119,126	3107	IRCM 103 / 112 M 4b		
	1,9	M8 (5m)	5,5	13	109,276	3919	IRCM 103 / 132 S 4c		
	2,2	M8 (5m)	5,5	15	95,896	3440	IRCM 103 / 132 S 4c		
	2,6	M8 (5m)	7,5	18	78,692	3849	IRCM 103 / 132 M 4b		
	2,8	M8 (5m)	7,5	19	71,869	3515	IRCM 103 / 132 M 4b		
	3,5	M8 (5m)	9,2	24	58,778	3526	IRCM 103 / 132 M 4c		
	4,0	M8 (5m)	9,2	27	51,907	3114	IRCM 103 / 132 M 4c		
	1,3	M7 (4m)	3	8,6	162,826	3186	IRCM 93 / 100 L 4b		
	1,4	M7 (4m)	3	9,5	146,946	2875	IRCM 93 / 100 L 4b		
	1,5	M7 (4m)	4	10	133,419	3480	IRCM 93 / 112 M 4b		
	1,9	M7 (4m)	5,5	13	111,602	4003	IRCM 93 / 132 S 4c		
	2,3	M7 (4m)	5,5	16	87,936	3154	IRCM 93 / 132 S 4c		
	2,6	M7 (4m)	7,5	18	79,841	3905	IRCM 93 / 132 M 4b		
	3,1	M6 (3m)	7,5	21	66,785	3266	IRCM 93 / 132 M 4b		
	3,4	M6 (3m)	7,5	23	61,444	3005	IRCM 93 / 132 M 4b		
	3,8	M6 (3m)	9,2	26	54,545	3272	IRCM 93 / 132 M 4c		
	4,5	M6 (3m)	11	31	44,753	3210	IRCM 93 / 160 M 4b		
5,6	M6 (3m)	15	38	37,199	3639	IRCM 93 / 160 L 4a			
6,0	M6 (3m)	15	41	34,034	3329	IRCM 93 / 160 L 4a			
6,6	M6 (3m)	15	45	31,194	3051	IRCM 93 / 160 L 4a			
1,1	M8 (5m)	3	7,0	199,476	3903	IRCM 103 / 100 L 4b			
1,2	M8 (5m)	3	7,9	177,284	3468	IRCM 103 / 100 L 4b			
1,5	M8 (5m)	4	10	143,552	3745	IRCM 103 / 112 M 4b			
1,8	M8 (5m)	4	12	119,126	3107	IRCM 103 / 112 M 4b			
2,0	M8 (5m)	5,5	13	109,276	3919	IRCM 103 / 132 S 4c			
2,3	M8 (5m)	5,5	15	95,896	3440	IRCM 103 / 132 S 4c			
2,7	M8 (5m)	7,5	18	78,692	3849	IRCM 103 / 132 M 4b			
2,9	M8 (5m)	7,5	19	71,869	3515	IRCM 103 / 132 M 4b			
3,6	M8 (5m)	9,2	24	58,778	3526	IRCM 103 / 132 M 4c			
4,1	M8 (5m)	9,2	27	51,907	3114	IRCM 103 / 132 M 4c			





D _T Tambur Çapı Drum Diameter <i>Diamètre de l'arbre</i> [mm]	V _h Kaldırma Hızı Lifting Speeds <i>Vitesse de levage</i> [m/min]	Vinç Sınıfı Crane Class <i>Classification de l'application de levage</i> ISO (FEM)	P ₁ Motor Gücü Power <i>Puissance</i> [kW]	n ₂ Çıkış Devri Output Speeds <i>Vitesse de sortie</i> [r.p.m]	i Tahvil Ratio <i>Rapport de réduction</i>	M ₂ Çıkış Momenti Output Torque <i>Couple de sortie</i>	Tip Type <i>Typ</i>		 kg
Ø290	1,3	M7 (4m)	3	8,6	162,826	3186	IRCM 93 / 100 L 4b		
	1,4	M7 (4m)	4	9,5	146,946	3833	IRCM 93 / 112 M 4b		
	1,5	M7 (4m)	4	10	133,419	3480	IRCM 93 / 112 M 4b		
	2,0	M7 (4m)	5,5	13	111,602	4003	IRCM 93 / 132 S 4c		
	2,4	M7 (4m)	5,5	16	87,936	3154	IRCM 93 / 132 S 4c		
	2,7	M6 (3m)	7,5	18	79,841	3905	IRCM 93 / 132 M 4b		
	3,2	M6 (3m)	7,5	21	66,785	3266	IRCM 93 / 132 M 4b		
	3,5	M6 (3m)	9,2	23	61,444	3686	IRCM 93 / 132 M 4c		
	3,9	M6 (3m)	9,2	26	54,545	3272	IRCM 93 / 132 M 4c		
	4,7	M6 (3m)	11	31	44,753	3210	IRCM 93 / 160 M 4b		
	5,8	M6 (3m)	15	38	37,199	3639	IRCM 93 / 160 L 4a		
	6,2	M6 (3m)	15	41	34,034	3329	IRCM 93 / 160 L 4a		
6,8	M6 (3m)	15	45	31,194	3051	IRCM 93 / 160 L 4a			
Ø300	1,1	M8 (5m)	3	7,0	199,476	3903	IRCM 103 / 100 L 4b		
	1,2	M8 (5m)	3	7,9	177,284	3468	IRCM 103 / 100 L 4b		
	1,5	M8 (5m)	4	10	143,552	3745	IRCM 103 / 112 M 4b		
	1,9	M8 (5m)	5,5	12	119,126	4273	IRCM 103 / 132 S 4c		
	2,0	M8 (5m)	5,5	13	109,276	3919	IRCM 103 / 132 S 4c		
	2,4	M8 (5m)	5,5	15	95,896	3440	IRCM 103 / 132 S 4c		
	2,8	M8 (5m)	7,5	18	78,692	3849	IRCM 103 / 132 M 4b		
	3,0	M8 (5m)	7,5	19	71,869	3515	IRCM 103 / 132 M 4b		
	3,8	M8 (5m)	9,2	24	58,778	3526	IRCM 103 / 132 M 4c		
	4,2	M8 (5m)	9,2	27	51,907	3114	IRCM 103 / 132 M 4c		
	1,4	M7 (4m)	3	8,6	162,826	3186	IRCM 93 / 100 L 4b		
	1,5	M7 (4m)	4	9,5	146,946	3833	IRCM 93 / 112 M 4b		
	1,6	M7 (4m)	4	10	133,419	3480	IRCM 93 / 112 M 4b		
	2,0	M7 (4m)	5,5	13	111,602	4003	IRCM 93 / 132 S 4c		
	2,5	M6 (3m)	5,5	16	87,936	3154	IRCM 93 / 132 S 4c		
	2,8	M6 (3m)	7,5	18	79,841	3905	IRCM 93 / 132 M 4b		
	3,3	M6 (3m)	7,5	21	66,785	3266	IRCM 93 / 132 M 4b		
	3,6	M6 (3m)	9,2	23	61,444	3686	IRCM 93 / 132 M 4c		
	4,1	M6 (3m)	9,2	26	54,545	3272	IRCM 93 / 132 M 4c		
	4,9	M6 (3m)	11	31	44,753	3210	IRCM 93 / 160 M 4b		
6,0	M6 (3m)	15	38	37,199	3639	IRCM 93 / 160 L 4a			
6,4	M6 (3m)	15	41	34,034	3329	IRCM 93 / 160 L 4a			
7,1	M6 (3m)	18,5	45	31,194	3763	IRCM 93 / 180 M 4b			



Vinç sistemleri kaldırma redüktörleri güç ve devir tabloları / Power and ratio table for hoisting applications / Tableau de classification des couples et rapports de réduction pour les applications de levage

D _T Tambur Çapı Drum Diameter <i>Diamètre de l'arbre</i> [mm]	V _h Kaldırma Hızı Lifting Speeds <i>Vitesse de levage</i> [m/min]	Vinç Sınıfı Crane Class <i>Classification de l'application de levage</i> ISO (FEM)	P ₁ Motor Gücü Power <i>Puissance</i> [kW]	n ₂ Çıkış Devri Output Speeds <i>Vitesse de sortie</i> [r.p.m]	i Tahvil Ratio <i>Rapport de réduction</i>	M ₂ Çıkış Momenti Output Torque <i>Couple de sortie</i>	Tip Type <i>Typ</i>		 kg
Ø170	0,6	M8 (5m)	1,5	8,6	162,826	1593	IRCM 93 / 90 L 4a		
	0,6	M8 (5m)	1,5	9,5	146,946	1437	IRCM 93 / 90 L 4a		
	0,7	M8 (5m)	1,5	10	133,419	1305	IRCM 93 / 90 L 4a		
	0,9	M8 (5m)	2,2	13	111,602	1601	IRCM 93 / 100 L 4a		
	1,1	M8 (5m)	3	16	87,936	1720	IRCM 93 / 100 L 4b		
	1,2	M8 (5m)	3	18	79,841	1562	IRCM 93 / 100 L 4b		
	1,4	M8 (5m)	4	21	66,785	1742	IRCM 93 / 112 M 4b		
	1,5	M8 (5m)	4	23	61,444	1603	IRCM 93 / 112 M 4b		
	1,7	M8 (5m)	4	26	54,545	1423	IRCM 93 / 112 M 4b		
	2,1	M8 (5m)	5,5	31	44,753	1605	IRCM 93 / 132 S 4c		
	2,5	M8 (5m)	5,5	38	37,199	1334	IRCM 93 / 132 S 4c		
	2,7	M8 (5m)	7,5	41	34,034	1665	IRCM 93 / 132 M 4b		
	3,0	M8 (5m)	7,5	45	31,194	1526	IRCM 93 / 132 M 4b		
	0,7	M7 (4m)	1,5	10	133,509	1306	IRCM 83 / 90 L 4a		
	0,8	M7 (4m)	2,2	12	121,711	1746	IRCM 83 / 100 L 4a		
	0,9	M7 (4m)	2,2	14	102,407	1469	IRCM 83 / 100 L 4a		
	1,0	M7 (4m)	2,2	15	92,330	1325	IRCM 83 / 100 L 4a		
	1,3	M7 (4m)	3	19	75,613	1479	IRCM 83 / 100 L 4b		
	1,5	M7 (4m)	4	23	60,299	1573	IRCM 83 / 112 M 4b		
	1,7	M6 (3m)	4	26	54,358	1418	IRCM 83 / 112 M 4b		
1,9	M6 (3m)	5,5	29	48,314	1733	IRCM 83 / 132 S 4c			
2,3	M6 (3m)	5,5	35	39,796	1427	IRCM 83 / 132 S 4c			
2,8	M6 (3m)	7,5	42	33,003	1614	IRCM 83 / 132 M 4b			
3,4	M6 (3m)	7,5	51	27,535	1347	IRCM 83 / 132 M 4b			
Ø180	0,6	M8 (5m)	1,5	8,6	162,826	1593	IRCM 93 / 90 L 4a		
	0,7	M8 (5m)	1,5	9,5	146,946	1437	IRCM 93 / 90 L 4a		
	0,7	M8 (5m)	2,2	10	133,419	1914	IRCM 93 / 100 L 4a		
	0,9	M8 (5m)	2,2	13	111,602	1601	IRCM 93 / 100 L 4a		
	1,1	M8 (5m)	3	16	87,936	1720	IRCM 93 / 100 L 4b		
	1,3	M8 (5m)	3	18	79,841	1562	IRCM 93 / 100 L 4b		
	1,5	M8 (5m)	4	21	66,785	1742	IRCM 93 / 112 M 4b		
	1,6	M8 (5m)	4	23	61,444	1603	IRCM 93 / 112 M 4b		
	1,8	M8 (5m)	4	26	54,545	1423	IRCM 93 / 112 M 4b		
	2,2	M8 (5m)	5,5	31	44,753	1605	IRCM 93 / 132 S 4c		
	2,7	M8 (5m)	7,5	38	37,199	1819	IRCM 93 / 132 M 4b		
	2,9	M8 (5m)	7,5	41	34,034	1665	IRCM 93 / 132 M 4b		
	3,2	M8 (5m)	7,5	45	31,194	1526	IRCM 93 / 132 M 4b		
	0,7	M6 (3m)	2,2	10	133,509	1915	IRCM 83 / 100 L 4a		
	0,8	M6 (3m)	2,2	12	121,711	1746	IRCM 83 / 100 L 4a		
	1,0	M6 (3m)	2,2	14	102,407	1469	IRCM 83 / 100 L 4a		
	1,1	M6 (3m)	3	15	92,330	1806	IRCM 83 / 100 L 4b		
	1,3	M6 (3m)	3	19	75,613	1479	IRCM 83 / 100 L 4b		
	1,6	M6 (3m)	4	23	60,299	1573	IRCM 83 / 112 M 4b		
	1,8	M6 (3m)	4	26	54,358	1418	IRCM 83 / 112 M 4b		
2,0	M6 (3m)	5,5	29	48,314	1733	IRCM 83 / 132 S 4c			
2,5	M6 (3m)	5,5	35	39,796	1427	IRCM 83 / 132 S 4c			
3,0	M6 (3m)	7,5	42	33,003	1614	IRCM 83 / 132 M 4b			
3,6	M6 (3m)	9,2	51	27,535	1652	IRCM 83 / 132 M 4c			



D _T Tambur Çapı Drum Diameter <i>Diamètre de l'arbre</i> [mm]	V _h Kaldırma Hızı Lifting Speeds <i>Vitesse de levage</i> [m/min]	Vinç Sınıfı Crane Class <i>Classification de l'application de levage</i> ISO (FEM)	P ₁ Motor Gücü Power <i>Puissance</i> [kW]	n ₂ Çıkış Devri Output Speeds <i>Vitesse de sortie</i> [r.p.m]	i Tahvil Ratio <i>Rapport de réduction</i>	M ₂ Çıkış Momenti Output Torque <i>Couple de sortie</i>	Tip Type <i>Typ</i>		 kg
Ø190	0,6	M8 (5m)	1,5	8,6	162,826	1593	IRCM 93 / 90 L 4a		
	0,7	M8 (5m)	2,2	9,5	146,946	2108	IRCM 93 / 100 L 4a		
	0,7	M8 (5m)	2,2	10	133,419	1914	IRCM 93 / 100 L 4a		
	1,0	M8 (5m)	2,2	13	111,602	1601	IRCM 93 / 100 L 4a		
	1,2	M8 (5m)	3	16	87,936	1720	IRCM 93 / 100 L 4b		
	1,3	M8 (5m)	3	18	79,841	1562	IRCM 93 / 100 L 4b		
	1,6	M8 (5m)	4	21	66,785	1742	IRCM 93 / 112 M 4b		
	1,7	M8 (5m)	4	23	61,444	1603	IRCM 93 / 112 M 4b		
	1,9	M8 (5m)	5,5	26	54,545	1956	IRCM 93 / 132 S 4c		
	2,3	M8 (5m)	5,5	31	44,753	1605	IRCM 93 / 132 S 4c		
	2,8	M8 (5m)	7,5	38	37,199	1819	IRCM 93 / 132 M 4b		
	3,1	M8 (5m)	7,5	41	34,034	1665	IRCM 93 / 132 M 4b		
	3,4	M8 (5m)	7,5	45	31,194	1526	IRCM 93 / 132 M 4b		
	0,7	M6 (3m)	2,2	10	133,509	1915	IRCM 83 / 100 L 4a		
	0,9	M6 (3m)	2,2	12	121,711	1746	IRCM 83 / 100 L 4a		
	1,0	M6 (3m)	3	14	102,407	2003	IRCM 83 / 100 L 4b		
	1,1	M6 (3m)	3	15	92,330	1806	IRCM 83 / 100 L 4b		
	1,4	M6 (3m)	4	19	75,613	1972	IRCM 83 / 112 M 4b		
	1,7	M6 (3m)	4	23	60,299	1573	IRCM 83 / 112 M 4b		
	1,9	M6 (3m)	5,5	26	54,358	1950	IRCM 83 / 132 S 4c		
	2,2	M6 (3m)	5,5	29	48,314	1733	IRCM 83 / 132 S 4c		
	2,6	M6 (3m)	7,5	35	39,796	1946	IRCM 83 / 132 M 4b		
3,1	M5 (2m)	7,5	42	33,003	1614	IRCM 83 / 132 M 4b			
3,8	M5 (2m)	9,2	51	27,535	1652	IRCM 83 / 132 M 4c			
Ø200	0,7	M8 (5m)	1,5	8,6	162,826	1593	IRCM 93 / 90 L 4a		
	0,7	M8 (5m)	2,2	9,5	146,946	2108	IRCM 93 / 100 L 4a		
	0,8	M8 (5m)	2,2	10	133,419	1914	IRCM 93 / 100 L 4a		
	1,0	M8 (5m)	2,2	13	111,602	1601	IRCM 93 / 100 L 4a		
	1,3	M8 (5m)	3	16	87,936	1720	IRCM 93 / 100 L 4b		
	1,4	M8 (5m)	4	18	79,841	2083	IRCM 93 / 112 M 4b		
	1,6	M8 (5m)	4	21	66,785	1742	IRCM 93 / 112 M 4b		
	1,8	M8 (5m)	4	23	61,444	1603	IRCM 93 / 112 M 4b		
	2,0	M8 (5m)	5,5	26	54,545	1956	IRCM 93 / 132 S 4c		
	2,4	M8 (5m)	5,5	31	44,753	1605	IRCM 93 / 132 S 4c		
	3,0	M8 (5m)	7,5	38	37,199	1819	IRCM 93 / 132 M 4b		
	3,2	M8 (5m)	7,5	41	34,034	1665	IRCM 93 / 132 M 4b		
	3,5	M8 (5m)	9,2	45	31,194	1872	IRCM 93 / 132 M 4c		
	0,8	M6 (3m)	2,2	10	133,509	1915	IRCM 83 / 100 L 4a		
	0,9	M6 (3m)	2,2	12	121,711	1746	IRCM 83 / 100 L 4a		
	1,1	M6 (3m)	3	14	102,407	2003	IRCM 83 / 100 L 4b		
	1,2	M6 (3m)	3	15	92,330	1806	IRCM 83 / 100 L 4b		
	1,5	M6 (3m)	4	19	75,613	1972	IRCM 83 / 112 M 4b		
	1,8	M6 (3m)	4	23	60,299	1573	IRCM 83 / 112 M 4b		
	2,0	M6 (3m)	5,5	26	54,358	1950	IRCM 83 / 132 S 4c		
	2,3	M6 (3m)	5,5	29	48,314	1733	IRCM 83 / 132 S 4c		
	2,7	M5 (2m)	7,5	35	39,796	1946	IRCM 83 / 132 M 4b		
3,3	M5 (2m)	7,5	42	33,003	1614	IRCM 83 / 132 M 4b			
4,0	M5 (2m)	9,2	51	27,535	1652	IRCM 83 / 132 M 4c			



Vinç sistemleri kaldırma redüktörleri güç ve devir tabloları / Power and ratio table for hoisting applications / Tableau de classification des couples et rapports de réduction pour les applications de levage



D _T Tambur Çapı Drum Diameter <i>Diamètre de l'arbre</i> [mm]	V _h Kaldırma Hızı Lifting Speeds <i>Vitesse de levage</i> [m/min]	Vinç Sınıfı Crane Class <i>Classification de l'application de levage</i> ISO (FEM)	P ₁ Motor Gücü Power <i>Puissance</i> [kW]	n ₂ Çıkış Devri Output Speeds <i>Vitesse de sortie</i> [r.p.m]	i Tahvil Ratio <i>Rapport de réduction</i>	M ₂ Çıkış Momenti Output Torque <i>Couple de sortie</i>	Tip Type <i>Typ</i>		 kg
Ø210	0,7	M8 (5m)	2,2	8,6	162,826	2336	IRCM 93 / 100 L 4a		
	0,8	M8 (5m)	2,2	9,5	146,946	2108	IRCM 93 / 100 L 4a		
	0,8	M8 (5m)	2,2	10	133,419	1914	IRCM 93 / 100 L 4a		
	1,1	M8 (5m)	3	13	111,602	2183	IRCM 93 / 100 L 4b		
	1,3	M8 (5m)	3	16	87,936	1720	IRCM 93 / 100 L 4b		
	1,5	M8 (5m)	4	18	79,841	2083	IRCM 93 / 112 M 4b		
	1,7	M8 (5m)	4	21	66,785	1742	IRCM 93 / 112 M 4b		
	1,9	M8 (5m)	5,5	23	61,444	2204	IRCM 93 / 132 S 4c		
	2,1	M8 (5m)	5,5	26	54,545	1956	IRCM 93 / 132 S 4c		
	2,6	M8 (5m)	5,5	31	44,753	1605	IRCM 93 / 132 S 4c		
	3,1	M8 (5m)	7,5	38	37,199	1819	IRCM 93 / 132 M 4b		
	3,4	M8 (5m)	7,5	41	34,034	1665	IRCM 93 / 132 M 4b		
3,7	M8 (5m)	9,2	45	31,194	1872	IRCM 93 / 132 M 4c			
Ø220	0,7	M8 (5m)	2,2	8,6	162,826	2336	IRCM 93 / 100 L 4a		
	0,8	M8 (5m)	2,2	9,5	146,946	2108	IRCM 93 / 100 L 4a		
	0,9	M8 (5m)	2,2	10	133,419	1914	IRCM 93 / 100 L 4a		
	1,1	M8 (5m)	3	13	111,602	2183	IRCM 93 / 100 L 4b		
	1,4	M8 (5m)	3	16	87,936	1720	IRCM 93 / 100 L 4b		
	1,6	M8 (5m)	4	18	79,841	2083	IRCM 93 / 112 M 4b		
	1,8	M8 (5m)	4	21	66,785	1742	IRCM 93 / 112 M 4b		
	2,0	M8 (5m)	5,5	23	61,444	2204	IRCM 93 / 132 S 4c		
	2,2	M8 (5m)	5,5	26	54,545	1956	IRCM 93 / 132 S 4c		
	2,7	M8 (5m)	7,5	31	44,753	2189	IRCM 93 / 132 M 4b		
	3,3	M8 (5m)	7,5	38	37,199	1819	IRCM 93 / 132 M 4b		
	3,5	M8 (5m)	9,2	41	34,034	2042	IRCM 93 / 132 M 4c		
3,9	M8 (5m)	9,2	45	31,194	1872	IRCM 93 / 132 M 4c			
Ø230	0,8	M8 (5m)	2,2	8,6	162,826	2336	IRCM 93 / 100 L 4a		
	0,9	M8 (5m)	2,2	9,5	146,946	2108	IRCM 93 / 100 L 4a		
	0,9	M8 (5m)	2,2	10	133,419	1914	IRCM 93 / 100 L 4a		
	1,2	M8 (5m)	3	13	111,602	2183	IRCM 93 / 100 L 4b		
	1,4	M8 (5m)	4	16	87,936	2294	IRCM 93 / 112 M 4b		
	1,6	M8 (5m)	4	18	79,841	2083	IRCM 93 / 112 M 4b		
	1,9	M8 (5m)	5,5	21	66,785	2395	IRCM 93 / 132 S 4c		
	2,1	M8 (5m)	5,5	23	61,444	2204	IRCM 93 / 132 S 4c		
	2,3	M8 (5m)	5,5	26	54,545	1956	IRCM 93 / 132 S 4c		
	2,8	M8 (5m)	7,5	31	44,753	2189	IRCM 93 / 132 M 4b		
	3,4	M8 (5m)	7,5	38	37,199	1819	IRCM 93 / 132 M 4b		
	3,7	M8 (5m)	9,2	41	34,034	2042	IRCM 93 / 132 M 4c		
4,1	M8 (5m)	9,2	45	31,194	1872	IRCM 93 / 132 M 4c			
Ø240	0,8	M8 (5m)	2,2	8,6	162,826	2336	IRCM 93 / 100 L 4a		
	0,9	M8 (5m)	2,2	9,5	146,946	2108	IRCM 93 / 100 L 4a		
	0,9	M8 (5m)	2,2	10	133,419	1914	IRCM 93 / 100 L 4a		
	1,2	M8 (5m)	3	13	111,602	2183	IRCM 93 / 100 L 4b		
	1,5	M8 (5m)	4	16	87,936	2294	IRCM 93 / 112 M 4b		
	1,7	M8 (5m)	4	18	79,841	2083	IRCM 93 / 112 M 4b		
	2,0	M8 (5m)	5,5	21	66,785	2395	IRCM 93 / 132 S 4c		
	2,2	M8 (5m)	5,5	23	61,444	2204	IRCM 93 / 132 S 4c		
	2,4	M8 (5m)	5,5	26	54,545	1956	IRCM 93 / 132 S 4c		
	2,9	M8 (5m)	7,5	31	44,753	2189	IRCM 93 / 132 M 4b		
	3,6	M8 (5m)	9,2	38	37,199	2232	IRCM 93 / 132 M 4c		
	3,9	M8 (5m)	9,2	41	34,034	2042	IRCM 93 / 132 M 4c		
4,2	M8 (5m)	9,2	45	31,194	1872	IRCM 93 / 132 M 4c			





D _T Tambur Çapı Drum Diameter <i>Diamètre de l'arbre</i> [mm]	V _h Kaldırma Hızı Lifting Speeds <i>Vitesse de levage</i> [m/min]	Vinç Sınıfı Crane Class <i>Classification de l'application de levage</i> ISO (FEM)	P ₁ Motor Gücü Power <i>Puissance</i> [kW]	n ₂ Çıkış Devri Output Speeds <i>Vitesse de sortie</i> [r.p.m]	i Tahvil Ratio <i>Rapport de réduction</i>	M ₂ Çıkış Momenti Output Torque <i>Couple de sortie</i>	Tip Type <i>Typ</i>		 kg
Ø280	1,6	M8 (5m)	5,5	7,1	198,333	7114	IRCM 123 / 132 S 4c		
	1,9	M8 (5m)	5,5	8,7	161,000	5775	IRCM 123 / 132 S 4c		
	2,2	M8 (5m)	7,5	10	134,473	6577	IRCM 123 / 132 M 4b		
	2,6	M8 (5m)	7,5	12	118,333	5788	IRCM 123 / 132 M 4b		
	2,9	M8 (5m)	9,2	13	105,000	6300	IRCM 123 / 132 M 4c		
	3,3	M8 (5m)	9,2	15	93,800	5628	IRCM 123 / 132 M 4c		
	3,7	M8 (5m)	11	17	84,259	6044	IRCM 123 / 160 M 4b		
	4,2	M8 (5m)	15	19	73,179	7158	IRCM 123 / 160 L 4a		
	4,8	M8 (5m)	15	22	64,396	6299	IRCM 123 / 160 L 4a		
	5,5	M8 (5m)	18,5	25	57,140	6894	IRCM 123 / 180 M 4b		
	5,9	M8 (5m)	18,5	27	51,045	6158	IRCM 123 / 180 M 4b		
	6,8	M8 (5m)	22	31	45,853	6578	IRCM 123 / 180 L 4b		
	1,5	M7 (4m)	5,5	7,0	199,476	7155	IRCM 103 / 132 S 4c		
	1,7	M7 (4m)	5,5	7,9	177,284	6359	IRCM 103 / 132 S 4c		
	2,2	M7 (4m)	7,5	10	143,552	7021	IRCM 103 / 132 M 4b		
	2,6	M7 (4m)	7,5	12	119,126	5826	IRCM 103 / 132 M 4b		
	2,9	M7 (4m)	9,2	13	109,276	6556	IRCM 103 / 132 M 4c		
	3,3	M7 (4m)	9,2	15	95,896	5753	IRCM 103 / 132 M 4c		
	4,0	M7 (4m)	11	18	78,692	5645	IRCM 103 / 160 M 4b		
	4,2	M7 (4m)	15	19	71,869	7030	IRCM 103 / 160 L 4a		
5,3	M7 (4m)	15	24	58,778	5750	IRCM 103 / 160 L 4a			
5,9	M7 (4m)	18,5	27	51,907	6262	IRCM 103 / 180 M 4b			
Ø290	1,6	M8 (5m)	5,5	7,1	198,333	7114	IRCM 123 / 132 S 4c		
	2,0	M8 (5m)	5,5	8,7	161,000	5775	IRCM 123 / 132 S 4c		
	2,3	M8 (5m)	7,5	10	134,473	6577	IRCM 123 / 132 M 4b		
	2,7	M8 (5m)	9,2	12	118,333	7099	IRCM 123 / 132 M 4c		
	3,0	M8 (5m)	9,2	13	105,000	6300	IRCM 123 / 132 M 4c		
	3,4	M8 (5m)	11	15	93,800	6729	IRCM 123 / 160 M 4b		
	3,9	M8 (5m)	11	17	84,259	6044	IRCM 123 / 160 M 4b		
	4,3	M8 (5m)	15	19	73,179	7158	IRCM 123 / 160 L 4a		
	5,0	M8 (5m)	15	22	64,396	6299	IRCM 123 / 160 L 4a		
	5,7	M8 (5m)	18,5	25	57,140	6894	IRCM 123 / 180 M 4b		
	6,1	M8 (5m)	18,5	27	51,045	6158	IRCM 123 / 180 M 4b		
	7,1	M8 (5m)	22	31	45,853	6578	IRCM 123 / 180 L 4b		
	1,6	M7 (4m)	5,5	7,0	199,476	7155	IRCM 103 / 132 S 4c		
	1,8	M7 (4m)	5,5	7,9	177,284	6359	IRCM 103 / 132 S 4c		
	2,2	M7 (4m)	7,5	10	143,552	7021	IRCM 103 / 132 M 4b		
	2,7	M7 (4m)	9,2	12	119,126	7147	IRCM 103 / 132 M 4c		
	3,0	M7 (4m)	9,2	13	109,276	6556	IRCM 103 / 132 M 4c		
	3,4	M7 (4m)	11	15	95,896	6879	IRCM 103 / 160 M 4b		
	4,1	M7 (4m)	15	18	78,692	7698	IRCM 103 / 160 L 4a		
	4,3	M7 (4m)	15	19	71,869	7030	IRCM 103 / 160 L 4a		
5,5	M7 (4m)	18,5	24	58,778	7091	IRCM 103 / 180 M 4b			
6,1	M7 (4m)	18,5	27	51,907	6262	IRCM 103 / 180 M 4b			
Ø300	1,7	M8 (5m)	5,5	7,1	198,333	7114	IRCM 123 / 132 S 4c		
	2,0	M8 (5m)	7,5	8,7	161,000	7874	IRCM 123 / 132 M 4b		
	2,4	M8 (5m)	7,5	10	134,473	6577	IRCM 123 / 132 M 4b		
	2,8	M8 (5m)	9,2	12	118,333	7099	IRCM 123 / 132 M 4c		
	3,1	M8 (5m)	9,2	13	105,000	6300	IRCM 123 / 132 M 4c		
	3,5	M8 (5m)	11	15	93,800	6729	IRCM 123 / 160 M 4b		
	4,0	M8 (5m)	15	17	84,259	8242	IRCM 123 / 160 L 4a		
	4,5	M8 (5m)	15	19	73,179	7158	IRCM 123 / 160 L 4a		
	5,2	M8 (5m)	15	22	64,396	6299	IRCM 123 / 160 L 4a		
	5,9	M8 (5m)	18,5	25	57,140	6894	IRCM 123 / 180 M 4b		
6,4	M8 (5m)	18,5	27	51,045	6158	IRCM 123 / 180 M 4b			
7,3	M8 (5m)	22	31	45,853	6578	IRCM 123 / 180 L 4b			



Vinç sistemleri kaldırma redüktörleri güç ve devir tabloları / Power and ratio table for hoisting applications / Tableau de classification des couples et rapports de réduction pour les applications de levage



D _T Tambur Çapı Drum Diameter <i>Diamètre de l'arbre</i> [mm]	V _h Kaldırma Hızı Lifting Speeds <i>Vitesse de levage</i> [m/min]	Vinç Sınıfı Crane Class <i>Classification de l'application de levage</i> ISO (FEM)	P ₁ Motor Gücü Power <i>Puissance</i> [kW]	n ₂ Çıkış Devri Output Speeds <i>Vitesse de sortie</i> [r.p.m]	i Tahvil Ratio <i>Rapport de réduction</i>	M ₂ Çıkış Momenti Output Torque <i>Couple de sortie</i>	Tip Type <i>Typ</i>		 kg
Ø320	1,6	M7 (4m)	5,5	7,0	199,476	7155	IRCM 103 / 132 S 4c		
	1,9	M7 (4m)	5,5	7,9	177,284	6359	IRCM 103 / 132 S 4c		
	2,3	M7 (4m)	7,5	10	143,552	7021	IRCM 103 / 132 M 4b		
	2,8	M7 (4m)	9,2	12	119,126	7147	IRCM 103 / 132 M 4c		
	3,1	M7 (4m)	9,2	13	109,276	6556	IRCM 103 / 132 M 4c		
	3,5	M7 (4m)	11	15	95,896	6879	IRCM 103 / 160 M 4b		
	4,2	M7 (4m)	15	18	78,692	7698	IRCM 103 / 160 L 4a		
	4,5	M7 (4m)	15	19	71,869	7030	IRCM 103 / 160 L 4a		
	5,7	M7 (4m)	18,5	24	58,778	7091	IRCM 103 / 180 M 4b		
	6,4	M7 (4m)	18,5	27	51,907	6262	IRCM 103 / 180 M 4b		
	1,8	M8 (5m)	5,5	7,1	198,333	7114	IRCM 123 / 132 S 4c		
	2,2	M8 (5m)	7,5	8,7	161,000	7874	IRCM 123 / 132 M 4b		
	2,5	M8 (5m)	7,5	10	134,473	6577	IRCM 123 / 132 M 4b		
	3,0	M8 (5m)	9,2	12	118,333	7099	IRCM 123 / 132 M 4c		
	3,3	M8 (5m)	9,2	13	105,000	6300	IRCM 123 / 132 M 4c		
	3,8	M8 (5m)	11	15	93,800	6729	IRCM 123 / 160 M 4b		
4,3	M8 (5m)	15	17	84,259	8242	IRCM 123 / 160 L 4a			
4,8	M8 (5m)	15	19	73,179	7158	IRCM 123 / 160 L 4a			
5,5	M8 (5m)	18,5	22	64,396	7769	IRCM 123 / 180 M 4b			
6,3	M8 (5m)	18,5	25	57,140	6894	IRCM 123 / 180 M 4b			
6,8	M8 (5m)	22	27	51,045	7323	IRCM 123 / 180 L 4b			
7,8	M8 (5m)	22	31	45,853	6578	IRCM 123 / 180 L 4b			
1,8	M7 (4m)	5,5	7,0	199,476	7155	IRCM 103 / 132 S 4c			
2,0	M7 (4m)	5,5	7,9	177,284	6359	IRCM 103 / 132 S 4c			
2,5	M7 (4m)	7,5	10	143,552	7021	IRCM 103 / 132 M 4b			
3,0	M7 (4m)	9,2	12	119,126	7147	IRCM 103 / 132 M 4c			
3,3	M7 (4m)	9,2	13	109,276	6556	IRCM 103 / 132 M 4c			
3,8	M7 (4m)	11	15	95,896	6879	IRCM 103 / 160 M 4b			
4,5	M7 (4m)	15	18	78,692	7698	IRCM 103 / 160 L 4a			
4,8	M7 (4m)	15	19	71,869	7030	IRCM 103 / 160 L 4a			
6,0	M7 (4m)	18,5	24	58,778	7091	IRCM 103 / 180 M 4b			
6,8	M6 (3m)	22	27	51,907	7447	IRCM 103 / 180 L 4b			
1,8	M7 (4m)	5,5	7,0	199,476	7155	IRCM 103 / 132 S 4c			
2,0	M7 (4m)	7,5	7,9	177,284	8671	IRCM 103 / 132 M 4b			
2,5	M7 (4m)	7,5	10	143,552	7021	IRCM 103 / 132 M 4b			
3,1	M7 (4m)	9,2	12	119,126	7147	IRCM 103 / 132 M 4c			
3,4	M7 (4m)	11	13	109,276	7839	IRCM 103 / 160 M 4b			
3,9	M7 (4m)	11	15	95,896	6879	IRCM 103 / 160 M 4b			
4,7	M7 (4m)	15	18	78,692	7698	IRCM 103 / 160 L 4a			
4,9	M7 (4m)	15	19	71,869	7030	IRCM 103 / 160 L 4a			
6,2	M7 (4m)	18,5	24	58,778	7091	IRCM 103 / 180 M 4b			
7,0	M6 (3m)	22	27	51,907	7447	IRCM 103 / 180 L 4b			
1,9	M8 (5m)	5,5	7,1	198,333	7114	IRCM 123 / 132 S 4c			
2,3	M8 (5m)	7,5	8,7	161,000	7874	IRCM 123 / 132 M 4b			
2,7	M8 (5m)	7,5	10	134,473	6577	IRCM 123 / 132 M 4b			
3,2	M8 (5m)	9,2	12	118,333	7099	IRCM 123 / 132 M 4c			
3,5	M8 (5m)	11	13	105,000	7532	IRCM 123 / 160 M 4b			
4,0	M8 (5m)	15	15	93,800	9175	IRCM 123 / 160 L 4a			
4,5	M8 (5m)	15	17	84,259	8242	IRCM 123 / 160 L 4a			
5,1	M8 (5m)	15	19	73,179	7158	IRCM 123 / 160 L 4a			
5,9	M8 (5m)	18,5	22	64,396	7769	IRCM 123 / 180 M 4b			
6,7	M8 (5m)	18,5	25	57,140	6894	IRCM 123 / 180 M 4b			
7,2	M8 (5m)	22	27	51,045	7323	IRCM 123 / 180 L 4b			
8,3	M8 (5m)	30	31	45,853	8971	IRCM 123 / 200 L 4c			



D _T Tambur Çapı Drum Diameter <i>Diamètre de l'arbre</i> [mm]	V _h Kaldırma Hızı Lifting Speeds <i>Vitesse de levage</i> [m/min]	Vinç Sınıfı Crane Class <i>Classification de l'application de levage</i> ISO (FEM)	P ₁ Motor Gücü Power <i>Puissance</i> [kW]	n ₂ Çıkış Devri Output Speeds <i>Vitesse de sortie</i> [r.p.m]	i Tahvil Ratio <i>Rapport de réduction</i>	M ₂ Çıkış Momenti Output Torque <i>Couple de sortie</i>	Tip Type <i>Typ</i>		 kg
Ø360	1,9	M7 (4m)	5,5	7,0	199,476	7155	IRCM 103 / 132 S 4c		
	2,1	M7 (4m)	7,5	7,9	177,284	8671	IRCM 103 / 132 M 4b		
	2,6	M7 (4m)	7,5	10	143,552	7021	IRCM 103 / 132 M 4b		
	3,2	M7 (4m)	9,2	12	119,126	7147	IRCM 103 / 132 M 4c		
	3,5	M7 (4m)	11	13	109,276	7839	IRCM 103 / 160 M 4b		
	4,0	M7 (4m)	15	15	95,896	9380	IRCM 103 / 160 L 4a		
	4,8	M7 (4m)	15	18	78,692	7698	IRCM 103 / 160 L 4a		
	5,1	M7 (4m)	15	19	71,869	7030	IRCM 103 / 160 L 4a		
	6,4	M6 (3m)	18,5	24	58,778	7091	IRCM 103 / 180 M 4b		
	7,2	M6 (3m)	22	27	51,907	7447	IRCM 103 / 180 L 4b		
Ø360	2,0	M8 (5m)	7,5	7,1	198,333	9700	IRCM 123 / 132 M 4b		
	2,5	M8 (5m)	7,5	8,7	161,000	7874	IRCM 123 / 132 M 4b		
	2,8	M8 (5m)	9,2	10	134,473	8068	IRCM 123 / 132 M 4c		
	3,4	M8 (5m)	11	12	118,333	8489	IRCM 123 / 160 M 4b		
	3,7	M8 (5m)	11	13	105,000	7532	IRCM 123 / 160 M 4b		
	4,2	M8 (5m)	15	15	93,800	9175	IRCM 123 / 160 L 4a		
	4,8	M8 (5m)	15	17	84,259	8242	IRCM 123 / 160 L 4a		
	5,4	M8 (5m)	15	19	73,179	7158	IRCM 123 / 160 L 4a		
	6,2	M8 (5m)	18,5	22	64,396	7769	IRCM 123 / 180 M 4b		
	7,1	M8 (5m)	22	25	57,140	8198	IRCM 123 / 180 L 4b		
Ø360	7,6	M8 (5m)	22	27	51,045	7323	IRCM 123 / 180 L 4b		
	8,8	M7 (4m)	30	31	45,853	8971	IRCM 123 / 200 L 4c		
	2,0	M6 (3m)	5,5	7,0	199,476	7155	IRCM 103 / 132 S 4c		
	2,2	M6 (3m)	7,5	7,9	177,284	8671	IRCM 103 / 132 M 4b		
	2,8	M6 (3m)	9,2	10	143,552	8613	IRCM 103 / 132 M 4c		
	3,4	M6 (3m)	11	12	119,126	8545	IRCM 103 / 160 M 4b		
	3,7	M6 (3m)	11	13	109,276	7839	IRCM 103 / 160 M 4b		
	4,2	M6 (3m)	15	15	95,896	9380	IRCM 103 / 160 L 4a		
	5,1	M6 (3m)	15	18	78,692	7698	IRCM 103 / 160 L 4a		
	5,4	M6 (3m)	15	19	71,869	7030	IRCM 103 / 160 L 4a		
Ø380	6,8	M6 (3m)	22	24	58,778	8433	IRCM 103 / 180 L 4b		
	7,6	M6 (3m)	22	27	51,907	7447	IRCM 103 / 180 L 4b		
	2,1	M8 (5m)	7,5	7,1	198,333	9700	IRCM 123 / 132 M 4b		
	2,6	M7 (4m)	7,5	8,7	161,000	7874	IRCM 123 / 132 M 4b		
	3,0	M7 (4m)	9,2	10	134,473	8068	IRCM 123 / 132 M 4c		
	3,6	M7 (4m)	11	12	118,333	8489	IRCM 123 / 160 M 4b		
	3,9	M7 (4m)	11	13	105,000	7532	IRCM 123 / 160 M 4b		
	4,5	M7 (4m)	15	15	93,800	9175	IRCM 123 / 160 L 4a		
	5,1	M7 (4m)	15	17	84,259	8242	IRCM 123 / 160 L 4a		
	5,7	M7 (4m)	18,5	19	73,179	8829	IRCM 123 / 180 M 4b		
Ø380	6,6	M7 (4m)	18,5	22	64,396	7769	IRCM 123 / 180 M 4b		
	7,5	M7 (4m)	22	25	57,140	8198	IRCM 123 / 180 L 4b		
	8,1	M7 (4m)	30	27	51,045	9986	IRCM 123 / 200 L 4c		
	9,2	M7 (4m)	30	31	45,853	8971	IRCM 123 / 200 L 4c		
	2,1	M6 (3m)	7,5	7,0	199,476	9756	IRCM 103 / 132 M 4b		
	2,4	M6 (3m)	7,5	7,9	177,284	8671	IRCM 103 / 132 M 4b		
	2,9	M6 (3m)	9,2	10	143,552	8613	IRCM 103 / 132 M 4c		
	3,6	M6 (3m)	11	12	119,126	8545	IRCM 103 / 160 M 4b		
	3,9	M6 (3m)	11	13	109,276	7839	IRCM 103 / 160 M 4b		
	4,5	M6 (3m)	15	15	95,896	9380	IRCM 103 / 160 L 4a		
Ø380	5,4	M6 (3m)	15	18	78,692	7698	IRCM 103 / 160 L 4a		
	5,7	M6 (3m)	18,5	19	71,869	8671	IRCM 103 / 180 M 4b		
	7,2	M6 (3m)	22	24	58,778	8433	IRCM 103 / 180 L 4b		
	8,1	M5 (2m)	30	27	51,907	10155	IRCM 103 / 200 L 4c		



Vinç sistemleri kaldırma redüktörleri güç ve devir tabloları / Power and ratio table for hoisting applications / Tableau de classification des couples et rapports de réduction pour les applications de levage

D _T Tambur Çapı Drum Diameter Diamètre de l'arbre [mm]	V _h Kaldırma Hızı Lifting Speeds Vitesse de levage [m/min]	Vinç Sınıfı Crane Class Classification de l'application de levage ISO (FEM)	P ₁ Motor Gücü Power Puissance [kW]	n ₂ Çıkış Devri Output Speeds Vitesse de sortie [r.p.m]	i Tahvil Ratio Rapport de réduction	M ₂ Çıkış Momenti Output Torque Couple de sortie	Tip Type Typ		 kg
Ø400	2,2	M7 (4m)	7,5	7,1	198,333	9700	IRCM 123 / 132 M 4b		
	2,7	M7 (4m)	9,2	8,7	161,000	9659	IRCM 123 / 132 M 4c		
	3,1	M7 (4m)	9,2	10	134,473	8068	IRCM 123 / 132 M 4c		
	3,8	M7 (4m)	11	12	118,333	8489	IRCM 123 / 160 M 4b		
	4,1	M7 (4m)	15	13	105,000	10271	IRCM 123 / 160 L 4a		
	4,7	M7 (4m)	15	15	93,800	9175	IRCM 123 / 160 L 4a		
	5,3	M7 (4m)	15	17	84,259	8242	IRCM 123 / 160 L 4a		
	6,0	M7 (4m)	18,5	19	73,179	8829	IRCM 123 / 180 M 4b		
	6,9	M7 (4m)	22	22	64,396	9239	IRCM 123 / 180 L 4b		
	7,9	M7 (4m)	22	25	57,140	8198	IRCM 123 / 180 L 4b		
	8,5	M7 (4m)	30	27	51,045	9986	IRCM 123 / 200 L 4c		
	9,7	M7 (4m)	30	31	45,853	8971	IRCM 123 / 200 L 4c		
	2,2	M6 (3m)	7,5	7,0	199,476	9756	IRCM 103 / 132 M 4b		
	2,5	M6 (3m)	7,5	7,9	177,284	8671	IRCM 103 / 132 M 4b		
	3,1	M6 (3m)	9,2	10	143,552	8613	IRCM 103 / 132 M 4c		
	3,8	M6 (3m)	11	12	119,126	8545	IRCM 103 / 160 M 4b		
	4,1	M6 (3m)	15	13	109,276	10689	IRCM 103 / 160 L 4a		
	4,7	M6 (3m)	15	15	95,896	9380	IRCM 103 / 160 L 4a		
	5,7	M6 (3m)	18,5	18	78,692	9494	IRCM 103 / 180 M 4b		
	6,0	M6 (3m)	18,5	19	71,869	8671	IRCM 103 / 180 M 4b		
7,5	M6 (3m)	22	24	58,778	8433	IRCM 103 / 180 L 4b			
8,5	M5 (2m)	30	27	51,907	10155	IRCM 103 / 200 L 4c			
Ø420	2,3	M7 (4m)	7,5	7,1	198,333	9700	IRCM 123 / 132 M 4b		
	2,9	M7 (4m)	9,2	8,7	161,000	9659	IRCM 123 / 132 M 4c		
	3,3	M7 (4m)	9,2	10	134,473	8068	IRCM 123 / 132 M 4c		
	4,0	M7 (4m)	11	12	118,333	8489	IRCM 123 / 160 M 4b		
	4,3	M7 (4m)	15	13	105,000	10271	IRCM 123 / 160 L 4a		
	4,9	M7 (4m)	15	15	93,800	9175	IRCM 123 / 160 L 4a		
	5,6	M7 (4m)	18,5	17	84,259	10165	IRCM 123 / 180 M 4b		
	6,3	M7 (4m)	18,5	19	73,179	8829	IRCM 123 / 180 M 4b		
	7,3	M7 (4m)	22	22	64,396	9239	IRCM 123 / 180 L 4b		
	8,2	M7 (4m)	30	25	57,140	11179	IRCM 123 / 200 L 4c		
	8,9	M7 (4m)	30	27	51,045	9986	IRCM 123 / 200 L 4c		
	10	M7 (4m)	30	31	45,853	8971	IRCM 123 / 200 L 4c		
	2,3	M6 (3m)	7,5	7,0	199,476	9756	IRCM 103 / 132 M 4b		
	2,6	M6 (3m)	7,5	7,9	177,284	8671	IRCM 103 / 132 M 4b		
	3,2	M6 (3m)	9,2	10	143,552	8613	IRCM 103 / 132 M 4c		
	4,0	M6 (3m)	11	12	119,126	8545	IRCM 103 / 160 M 4b		
	4,3	M6 (3m)	15	13	109,276	10689	IRCM 103 / 160 L 4a		
	4,9	M6 (3m)	15	15	95,896	9380	IRCM 103 / 160 L 4a		
	5,9	M6 (3m)	18,5	18	78,692	9494	IRCM 103 / 180 M 4b		
	6,3	M6 (3m)	18,5	19	71,869	8671	IRCM 103 / 180 M 4b		
7,9	M5 (2m)	22	24	58,778	8433	IRCM 103 / 180 L 4b			
8,9	M5 (2m)	30	27	51,907	10155	IRCM 103 / 200 L 4c			





D _T Tambur Çapı Drum Diameter <i>Diamètre de l'arbre</i> [mm]	V _h Kaldırma Hızı Lifting Speeds <i>Vitesse de levage</i> [m/min]	Vinç Sınıfı Crane Class <i>Classification de l'application de levage</i> ISO (FEM)	P ₁ Motor Gücü Power <i>Puissance</i> [kW]	n ₂ Çıkış Devri Output Speeds <i>Vitesse de sortie</i> [r.p.m]	i Tahvil Ratio <i>Rapport de réduction</i>	M ₂ Çıkış Momenti Output Torque <i>Couple de sortie</i>	Tip Type <i>Typ</i>		 kg
Ø270	1,0	M8 (5m)	3	7,0	199,476	3903	IRCM 103 / 100 L 4b		
	1,1	M8 (5m)	4	7,9	177,284	4624	IRCM 103 / 112 M 4b		
	1,4	M8 (5m)	4	10	143,552	3745	IRCM 103 / 112 M 4b		
	1,7	M8 (5m)	5,5	12	119,126	4273	IRCM 103 / 132 S 4c		
	1,8	M8 (5m)	5,5	13	109,276	3919	IRCM 103 / 132 S 4c		
	2,1	M8 (5m)	7,5	15	95,896	4690	IRCM 103 / 132 M 4b		
	2,5	M8 (5m)	7,5	18	78,692	3849	IRCM 103 / 132 M 4b		
	2,7	M8 (5m)	7,5	19	71,869	3515	IRCM 103 / 132 M 4b		
	3,4	M8 (5m)	11	24	58,778	4216	IRCM 103 / 160 M 4b		
	3,8	M8 (5m)	11	27	51,907	3724	IRCM 103 / 160 M 4b		
	1,2	M6 (3m)	4	8,6	162,826	4247	IRCM 93 / 112 M 4b		
	1,3	M6 (3m)	4	9,5	146,946	3833	IRCM 93 / 112 M 4b		
	1,4	M6 (3m)	4	10	133,419	3480	IRCM 93 / 112 M 4b		
	1,8	M6 (3m)	5,5	13	111,602	4003	IRCM 93 / 132 S 4c		
	2,3	M6 (3m)	7,5	16	87,936	4301	IRCM 93 / 132 M 4b		
	2,5	M6 (3m)	7,5	18	79,841	3905	IRCM 93 / 132 M 4b		
	3,0	M5 (2m)	9,2	21	66,785	4007	IRCM 93 / 132 M 4c		
	3,2	M5 (2m)	9,2	23	61,444	3686	IRCM 93 / 132 M 4c		
	3,7	M5 (2m)	11	26	54,545	3913	IRCM 93 / 160 M 4b		
	4,4	M5 (2m)	15	31	44,753	4378	IRCM 93 / 160 L 4a		
5,4	M4 (1Am)	15	38	37,199	3639	IRCM 93 / 160 L 4a			
5,8	M4 (1Am)	18,5	41	34,034	4106	IRCM 93 / 180 M 4b			
6,4	M4 (1Am)	18,5	45	31,194	3763	IRCM 93 / 180 M 4b			
Ø280	1,0	M8 (5m)	3	7,0	199,476	3903	IRCM 103 / 100 L 4b		
	1,2	M8 (5m)	4	7,9	177,284	4624	IRCM 103 / 112 M 4b		
	1,4	M8 (5m)	4	10	143,552	3745	IRCM 103 / 112 M 4b		
	1,8	M8 (5m)	5,5	12	119,126	4273	IRCM 103 / 132 S 4c		
	1,9	M8 (5m)	5,5	13	109,276	3919	IRCM 103 / 132 S 4c		
	2,2	M8 (5m)	7,5	15	95,896	4690	IRCM 103 / 132 M 4b		
	2,6	M8 (5m)	7,5	18	78,692	3849	IRCM 103 / 132 M 4b		
	2,8	M8 (5m)	9,2	19	71,869	4312	IRCM 103 / 132 M 4c		
	3,5	M8 (5m)	11	24	58,778	4216	IRCM 103 / 160 M 4b		
	4,0	M8 (5m)	11	27	51,907	3724	IRCM 103 / 160 M 4b		
	1,3	M6 (3m)	4	8,6	162,826	4247	IRCM 93 / 112 M 4b		
	1,4	M6 (3m)	4	9,5	146,946	3833	IRCM 93 / 112 M 4b		
	1,5	M6 (3m)	5,5	10	133,419	4785	IRCM 93 / 132 S 4c		
	1,9	M6 (3m)	5,5	13	111,602	4003	IRCM 93 / 132 S 4c		
	2,3	M6 (3m)	7,5	16	87,936	4301	IRCM 93 / 132 M 4b		
	2,6	M5 (2m)	7,5	18	79,841	3905	IRCM 93 / 132 M 4b		
	3,1	M5 (2m)	9,2	21	66,785	4007	IRCM 93 / 132 M 4c		
	3,4	M5 (2m)	11	23	61,444	4408	IRCM 93 / 160 M 4b		
	3,8	M5 (2m)	11	26	54,545	3913	IRCM 93 / 160 M 4b		
	4,5	M4 (1Am)	15	31	44,753	4378	IRCM 93 / 160 L 4a		
5,6	M4 (1Am)	18,5	38	37,199	4488	IRCM 93 / 180 M 4b			
6,0	M4 (1Am)	18,5	41	34,034	4106	IRCM 93 / 180 M 4b			
6,6	M4 (1Am)	18,5	45	31,194	3763	IRCM 93 / 180 M 4b			
	1,1	M8 (5m)	3	7,0	199,476	3903	IRCM 103 / 100 L 4b		
	1,2	M8 (5m)	4	7,9	177,284	4624	IRCM 103 / 112 M 4b		
	1,5	M8 (5m)	5,5	10	143,552	5149	IRCM 103 / 132 S 4c		
	1,8	M8 (5m)	5,5	12	119,126	4273	IRCM 103 / 132 S 4c		
	2,0	M8 (5m)	5,5	13	109,276	3919	IRCM 103 / 132 S 4c		
	2,3	M8 (5m)	7,5	15	95,896	4690	IRCM 103 / 132 M 4b		
	2,7	M8 (5m)	9,2	18	78,692	4721	IRCM 103 / 132 M 4c		
	2,9	M8 (5m)	9,2	19	71,869	4312	IRCM 103 / 132 M 4c		
	3,6	M8 (5m)	11	24	58,778	4216	IRCM 103 / 160 M 4b		
	4,1	M8 (5m)	15	27	51,907	5078	IRCM 103 / 160 L 4a		





Vinc sistemleri kaldırma redüktörleri güç ve devir tabloları / Power and ratio table for hoisting applications / Tableau de classification des couples et rapports de réduction pour les applications de levage

D _T Tambur Çapı Drum Diameter <i>Diamètre de l'arbre</i> [mm]	V _h Kaldırma Hızı Lifting Speeds <i>Vitesse de levage</i> [m/min]	Vinc Sınıfı Crane Class <i>Classification de l'application de levage</i> ISO (FEM)	P ₁ Motor Gücü Power <i>Puissance</i> [kW]	n ₂ Çıkış Devri Output Speeds <i>Vitesse de sortie</i> [r.p.m]	i Tahvil Ratio <i>Rapport de réduction</i>	M ₂ Çıkış Momenti Output Torque <i>Couple de sortie</i>	Tip Type <i>Typ</i>		 kg
Ø290	1,3	M6 (3m)	4	8,6	162,826	4247	IRCM 93 / 112 M 4b		
	1,4	M6 (3m)	4	9,5	146,946	3833	IRCM 93 / 112 M 4b		
	1,5	M6 (3m)	5,5	10	133,419	4785	IRCM 93 / 132 S 4c		
	2,0	M6 (3m)	5,5	13	111,602	4003	IRCM 93 / 132 S 4c		
	2,4	M5 (2m)	7,5	16	87,936	4301	IRCM 93 / 132 M 4b		
	2,7	M5 (2m)	9,2	18	79,841	4790	IRCM 93 / 132 M 4c		
	3,2	M5 (2m)	9,2	21	66,785	4007	IRCM 93 / 132 M 4c		
	3,5	M5 (2m)	11	23	61,444	4408	IRCM 93 / 160 M 4b		
	3,9	M4 (1Am)	11	26	54,545	3913	IRCM 93 / 160 M 4b		
	4,7	M4 (1Am)	15	31	44,753	4378	IRCM 93 / 160 L 4a		
	5,8	M4 (1Am)	18,5	38	37,199	4488	IRCM 93 / 180 M 4b		
6,2	M4 (1Am)	18,5	41	34,034	4106	IRCM 93 / 180 M 4b			
Ø300	1,1	M8 (5m)	4	7,0	199,476	5203	IRCM 103 / 112 M 4b		
	1,2	M8 (5m)	4	7,9	177,284	4624	IRCM 103 / 112 M 4b		
	1,5	M8 (5m)	5,5	10	143,552	5149	IRCM 103 / 132 S 4c		
	1,9	M8 (5m)	5,5	12	119,126	4273	IRCM 103 / 132 S 4c		
	2,0	M8 (5m)	7,5	13	109,276	5345	IRCM 103 / 132 M 4b		
	2,4	M8 (5m)	7,5	15	95,896	4690	IRCM 103 / 132 M 4b		
	2,8	M8 (5m)	9,2	18	78,692	4721	IRCM 103 / 132 M 4c		
	3,0	M8 (5m)	9,2	19	71,869	4312	IRCM 103 / 132 M 4c		
	3,8	M8 (5m)	11	24	58,778	4216	IRCM 103 / 160 M 4b		
	4,2	M8 (5m)	15	27	51,907	5078	IRCM 103 / 160 L 4a		
	1,4	M6 (3m)	4	8,6	162,826	4247	IRCM 93 / 112 M 4b		
	1,5	M6 (3m)	5,5	9,5	146,946	5271	IRCM 93 / 132 S 4c		
	1,6	M6 (3m)	5,5	10	133,419	4785	IRCM 93 / 132 S 4c		
	2,0	M5 (2m)	7,5	13	111,602	5458	IRCM 93 / 132 M 4b		
	2,5	M5 (2m)	7,5	16	87,936	4301	IRCM 93 / 132 M 4b		
	2,8	M5 (2m)	9,2	18	79,841	4790	IRCM 93 / 132 M 4c		
	3,3	M4 (1Am)	9,2	21	66,785	4007	IRCM 93 / 132 M 4c		
	3,6	M4 (1Am)	11	23	61,444	4408	IRCM 93 / 160 M 4b		
	4,1	M4 (1Am)	15	26	54,545	5336	IRCM 93 / 160 L 4a		
4,9	M4 (1Am)	15	31	44,753	4378	IRCM 93 / 160 L 4a			
6,0	M4 (1Am)	18,5	38	37,199	4488	IRCM 93 / 180 M 4b			
6,4	M4 (1Am)	18,5	41	34,034	4106	IRCM 93 / 180 M 4b			
Ø310	1,1	M8 (5m)	4	7,0	199,476	5203	IRCM 103 / 112 M 4b		
	1,3	M8 (5m)	4	7,9	177,284	4624	IRCM 103 / 112 M 4b		
	1,6	M8 (5m)	5,5	10	143,552	5149	IRCM 103 / 132 S 4c		
	1,9	M8 (5m)	5,5	12	119,126	4273	IRCM 103 / 132 S 4c		
	2,1	M8 (5m)	7,5	13	109,276	5345	IRCM 103 / 132 M 4b		
	2,4	M8 (5m)	7,5	15	95,896	4690	IRCM 103 / 132 M 4b		
	2,9	M8 (5m)	9,2	18	78,692	4721	IRCM 103 / 132 M 4c		
	3,1	M8 (5m)	9,2	19	71,869	4312	IRCM 103 / 132 M 4c		
	3,9	M8 (5m)	11	24	58,778	4216	IRCM 103 / 160 M 4b		
	4,4	M8 (5m)	15	27	51,907	5078	IRCM 103 / 160 L 4a		
	1,4	M6 (3m)	4	8,6	162,826	4247	IRCM 93 / 112 M 4b		
	1,5	M6 (3m)	5,5	9,5	146,946	5271	IRCM 93 / 132 S 4c		
	1,6	M5 (2m)	5,5	10	133,419	4785	IRCM 93 / 132 S 4c		
	2,1	M5 (2m)	7,5	13	111,602	5458	IRCM 93 / 132 M 4b		
	2,6	M5 (2m)	7,5	16	87,936	4301	IRCM 93 / 132 M 4b		
	2,9	M4 (1Am)	9,2	18	79,841	4790	IRCM 93 / 132 M 4c		
	3,4	M4 (1Am)	11	21	66,785	4791	IRCM 93 / 160 M 4b		
	3,7	M4 (1Am)	11	23	61,444	4408	IRCM 93 / 160 M 4b		
	4,2	M4 (1Am)	15	26	54,545	5336	IRCM 93 / 160 L 4a		
	5,0	M3 (1Bm)	15	31	44,753	4378	IRCM 93 / 160 L 4a		
6,2	M3 (1Bm)	18,5	38	37,199	4488	IRCM 93 / 180 M 4b			



D _T Tambur Çapı Drum Diameter <i>Diamètre de l'arbre</i> [mm]	V _h Kaldırma Hızı Lifting Speeds <i>Vitesse de levage</i> [m/min]	Vinç Sınıfı Crane Class <i>Classification de l'application de levage</i> ISO (FEM)	P ₁ Motor Gücü Power <i>Puissance</i> [kW]	n ₂ Çıkış Devri Output Speeds <i>Vitesse de sortie</i> [r.p.m]	i Tahvil Ratio <i>Rapport de réduction</i>	M ₂ Çıkış Momenti Output Torque <i>Couple de sortie</i>	Tip Type <i>Typ</i>		 kg
Ø320	1,2	M8 (5m)	4	7,0	199,476	5203	IRCM 103 / 112 M 4b		
	1,3	M8 (5m)	4	7,9	177,284	4624	IRCM 103 / 112 M 4b		
	1,6	M8 (5m)	5,5	10	143,552	5149	IRCM 103 / 132 S 4c		
	2,0	M8 (5m)	7,5	12	119,126	5826	IRCM 103 / 132 M 4b		
	2,2	M8 (5m)	7,5	13	109,276	5345	IRCM 103 / 132 M 4b		
	2,5	M8 (5m)	7,5	15	95,896	4690	IRCM 103 / 132 M 4b		
	3,0	M8 (5m)	9,2	18	78,692	4721	IRCM 103 / 132 M 4c		
	3,2	M8 (5m)	9,2	19	71,869	4312	IRCM 103 / 132 M 4c		
	4,0	M8 (5m)	15	24	58,778	5750	IRCM 103 / 160 L 4a		
	4,5	M8 (5m)	15	27	51,907	5078	IRCM 103 / 160 L 4a		
	1,4	M5 (2m)	4	8,6	162,826	4247	IRCM 93 / 112 M 4b		
	1,6	M5 (2m)	5,5	9,5	146,946	5271	IRCM 93 / 132 S 4c		
	1,7	M5 (2m)	5,5	10	133,419	4785	IRCM 93 / 132 S 4c		
	2,2	M5 (2m)	7,5	13	111,602	5458	IRCM 93 / 132 M 4b		
	2,7	M4 (1Am)	7,5	16	87,936	4301	IRCM 93 / 132 M 4b		
	3,0	M4 (1Am)	9,2	18	79,841	4790	IRCM 93 / 132 M 4c		
	3,5	M4 (1Am)	11	21	66,785	4791	IRCM 93 / 160 M 4b		
	3,9	M4 (1Am)	11	23	61,444	4408	IRCM 93 / 160 M 4b		
4,4	M3 (1Bm)	15	26	54,545	5336	IRCM 93 / 160 L 4a			
5,2	M3 (1Bm)	15	31	44,753	4378	IRCM 93 / 160 L 4a			
Ø330	1,2	M8 (5m)	4	7,0	199,476	5203	IRCM 103 / 112 M 4b		
	1,3	M8 (5m)	4	7,9	177,284	4624	IRCM 103 / 112 M 4b		
	1,6	M8 (5m)	5,5	10	143,552	5149	IRCM 103 / 132 S 4c		
	2,0	M8 (5m)	7,5	12	119,126	5826	IRCM 103 / 132 M 4b		
	2,2	M8 (5m)	7,5	13	109,276	5345	IRCM 103 / 132 M 4b		
	2,5	M8 (5m)	7,5	15	95,896	4690	IRCM 103 / 132 M 4b		
	3,0	M8 (5m)	9,2	18	78,692	4721	IRCM 103 / 132 M 4c		
	3,2	M8 (5m)	9,2	19	71,869	4312	IRCM 103 / 132 M 4c		
	4,0	M8 (5m)	15	24	58,778	5750	IRCM 103 / 160 L 4a		
	4,5	M8 (5m)	15	27	51,907	5078	IRCM 103 / 160 L 4a		
Ø340	1,2	M8 (5m)	4	7,0	199,476	5203	IRCM 103 / 112 M 4b		
	1,4	M8 (5m)	4	7,9	177,284	4624	IRCM 103 / 112 M 4b		
	1,7	M8 (5m)	5,5	10	143,552	5149	IRCM 103 / 132 S 4c		
	2,1	M8 (5m)	7,5	12	119,126	5826	IRCM 103 / 132 M 4b		
	2,3	M8 (5m)	7,5	13	109,276	5345	IRCM 103 / 132 M 4b		
	2,7	M8 (5m)	7,5	15	95,896	4690	IRCM 103 / 132 M 4b		
	3,2	M8 (5m)	9,2	18	78,692	4721	IRCM 103 / 132 M 4c		
	3,4	M8 (5m)	11	19	71,869	5155	IRCM 103 / 160 M 4b		
	4,3	M8 (5m)	15	24	58,778	5750	IRCM 103 / 160 L 4a		
	4,8	M8 (5m)	15	27	51,907	5078	IRCM 103 / 160 L 4a		





D _T Tambur Çapı Drum Diameter <i>Diamètre de l'arbre</i> [mm]	V _h Kaldırma Hızı Lifting Speeds <i>Vitesse de levage</i> [m/min]	Vinç Sınıfı Crane Class <i>Classification de l'application de levage</i> ISO (FEM)	P ₁ Motor Gücü Power <i>Puissance</i> [kW]	n ₂ Çıkış Devri Output Speeds <i>Vitesse de sortie</i> [r.p.m]	i Tahvil Ratio <i>Rapport de réduction</i>	M ₂ Çıkış Momenti Output Torque <i>Couple de sortie</i>	Tip Type <i>Typ</i>		 kg
Ø230	0,8	M8 (5m)	2,2	8,6	162,826	2336	IRCM 93 / 100 L 4a		
	0,9	M8 (5m)	3	9,5	146,946	2875	IRCM 93 / 100 L 4b		
	0,9	M8 (5m)	3	10	133,419	2610	IRCM 93 / 100 L 4b		
	1,2	M8 (5m)	4	13	111,602	2911	IRCM 93 / 112 M 4b		
	1,4	M8 (5m)	4	16	87,936	2294	IRCM 93 / 112 M 4b		
	1,6	M8 (5m)	5,5	18	79,841	2864	IRCM 93 / 132 S 4c		
	1,9	M7 (4m)	5,5	21	66,785	2395	IRCM 93 / 132 S 4c		
	2,1	M7 (4m)	7,5	23	61,444	3005	IRCM 93 / 132 M 4b		
	2,3	M7 (4m)	7,5	26	54,545	2668	IRCM 93 / 132 M 4b		
	2,8	M7 (4m)	9,2	31	44,753	2685	IRCM 93 / 132 M 4c		
	3,4	M7 (4m)	11	38	37,199	2668	IRCM 93 / 160 M 4b		
	3,7	M7 (4m)	11	41	34,034	2441	IRCM 93 / 160 M 4b		
Ø240	4,1	M7 (4m)	15	45	31,194	3051	IRCM 93 / 160 L 4a		
	0,8	M8 (5m)	3	8,6	162,826	3186	IRCM 93 / 100 L 4b		
	0,9	M8 (5m)	3	9,5	146,946	2875	IRCM 93 / 100 L 4b		
	0,9	M8 (5m)	3	10	133,419	2610	IRCM 93 / 100 L 4b		
	1,2	M8 (5m)	4	13	111,602	2911	IRCM 93 / 112 M 4b		
	1,5	M8 (5m)	5,5	16	87,936	3154	IRCM 93 / 132 S 4c		
	1,7	M7 (4m)	5,5	18	79,841	2864	IRCM 93 / 132 S 4c		
	2,0	M7 (4m)	5,5	21	66,785	2395	IRCM 93 / 132 S 4c		
	2,2	M7 (4m)	7,5	23	61,444	3005	IRCM 93 / 132 M 4b		
	2,4	M7 (4m)	7,5	26	54,545	2668	IRCM 93 / 132 M 4b		
	2,9	M7 (4m)	9,2	31	44,753	2685	IRCM 93 / 132 M 4c		
	3,6	M7 (4m)	11	38	37,199	2668	IRCM 93 / 160 M 4b		
Ø250	3,9	M7 (4m)	11	41	34,034	2441	IRCM 93 / 160 M 4b		
	4,2	M7 (4m)	15	45	31,194	3051	IRCM 93 / 160 L 4a		
	0,7	M8 (5m)	2,2	7,0	199,476	2862	IRCM 103 / 100 L 4a		
	0,8	M8 (5m)	2,2	7,9	177,284	2543	IRCM 103 / 100 L 4a		
	1,0	M8 (5m)	3	10	143,552	2808	IRCM 103 / 100 L 4b		
	1,2	M8 (5m)	4	12	119,126	3107	IRCM 103 / 112 M 4b		
	1,3	M8 (5m)	4	13	109,276	2850	IRCM 103 / 112 M 4b		
	1,5	M8 (5m)	5,5	15	95,896	3440	IRCM 103 / 132 S 4c		
	1,8	M8 (5m)	5,5	18	78,692	2822	IRCM 103 / 132 S 4c		
	1,9	M8 (5m)	5,5	19	71,869	2578	IRCM 103 / 132 S 4c		
	2,4	M8 (5m)	7,5	24	58,778	2875	IRCM 103 / 132 M 4b		
	2,6	M8 (5m)	7,5	27	51,907	2539	IRCM 103 / 132 M 4b		
Ø250	0,8	M8 (5m)	3	8,6	162,826	3186	IRCM 93 / 100 L 4b		
	0,9	M8 (5m)	3	9,5	146,946	2875	IRCM 93 / 100 L 4b		
	1,0	M8 (5m)	3	10	133,419	2610	IRCM 93 / 100 L 4b		
	1,3	M8 (5m)	4	13	111,602	2911	IRCM 93 / 112 M 4b		
	1,6	M7 (4m)	5,5	16	87,936	3154	IRCM 93 / 132 S 4c		
	1,8	M7 (4m)	5,5	18	79,841	2864	IRCM 93 / 132 S 4c		
	2,1	M7 (4m)	7,5	21	66,785	3266	IRCM 93 / 132 M 4b		
	2,3	M7 (4m)	7,5	23	61,444	3005	IRCM 93 / 132 M 4b		
	2,6	M7 (4m)	7,5	26	54,545	2668	IRCM 93 / 132 M 4b		
	3,0	M7 (4m)	9,2	31	44,753	2685	IRCM 93 / 132 M 4c		
	3,7	M7 (4m)	11	38	37,199	2668	IRCM 93 / 160 M 4b		
	4,0	M7 (4m)	15	41	34,034	3329	IRCM 93 / 160 L 4a		
4,4	M7 (4m)	15	45	31,194	3051	IRCM 93 / 160 L 4a			





D _T Tambur Çapı Drum Diameter <i>Diamètre de l'arbre</i> [mm]	V _h Kaldırma Hızı Lifting Speeds <i>Vitesse de levage</i> [m/min]	Vinç Sınıfı Crane Class <i>Classification de l'application de levage</i> ISO (FEM)	P ₁ Motor Gücü Power <i>Puissance</i> [kW]	n ₂ Çıkış Devri Output Speeds <i>Vitesse de sortie</i> [r.p.m]	i Tahvil Ratio <i>Rapport de réduction</i>	M ₂ Çıkış Momenti Output Torque <i>Couple de sortie</i>	Tip Type <i>Typ</i>		 kg
Ø260	0,7	M8 (5m)	2,2	7,0	199,476	2862	IRCM 103 / 100 L 4a		
	0,8	M8 (5m)	3	7,9	177,284	3468	IRCM 103 / 100 L 4b		
	1,0	M8 (5m)	3	10	143,552	2808	IRCM 103 / 100 L 4b		
	1,2	M8 (5m)	4	12	119,126	3107	IRCM 103 / 112 M 4b		
	1,3	M8 (5m)	4	13	109,276	2850	IRCM 103 / 112 M 4b		
	1,5	M8 (5m)	5,5	15	95,896	3440	IRCM 103 / 132 S 4c		
	1,8	M8 (5m)	5,5	18	78,692	2822	IRCM 103 / 132 S 4c		
	1,9	M8 (5m)	5,5	19	71,869	2578	IRCM 103 / 132 S 4c		
	2,4	M8 (5m)	7,5	24	58,778	2875	IRCM 103 / 132 M 4b		
	2,8	M8 (5m)	9,2	27	51,907	3114	IRCM 103 / 132 M 4c		
	0,9	M8 (5m)	3	8,6	162,826	3186	IRCM 93 / 100 L 4b		
	1,0	M8 (5m)	3	9,5	146,946	2875	IRCM 93 / 100 L 4b		
	1,0	M8 (5m)	3	10	133,419	2610	IRCM 93 / 100 L 4b		
	1,3	M7 (4m)	4	13	111,602	2911	IRCM 93 / 112 M 4b		
	1,6	M7 (4m)	5,5	16	87,936	3154	IRCM 93 / 132 S 4c		
	1,8	M7 (4m)	5,5	18	79,841	2864	IRCM 93 / 132 S 4c		
	2,1	M7 (4m)	7,5	21	66,785	3266	IRCM 93 / 132 M 4b		
	2,3	M7 (4m)	7,5	23	61,444	3005	IRCM 93 / 132 M 4b		
	2,7	M7 (4m)	7,5	26	54,545	2668	IRCM 93 / 132 M 4b		
	3,2	M7 (4m)	9,2	31	44,753	2685	IRCM 93 / 132 M 4c		
3,9	M6 (3m)	11	38	37,199	2668	IRCM 93 / 160 M 4b			
4,2	M6 (3m)	15	41	34,034	3329	IRCM 93 / 160 L 4a			
4,6	M6 (3m)	15	45	31,194	3051	IRCM 93 / 160 L 4a			
Ø270	0,7	M8 (5m)	2,2	7,0	199,476	2862	IRCM 103 / 100 L 4a		
	0,8	M8 (5m)	3	7,9	177,284	3468	IRCM 103 / 100 L 4b		
	1,0	M8 (5m)	3	10	143,552	2808	IRCM 103 / 100 L 4b		
	1,3	M8 (5m)	4	12	119,126	3107	IRCM 103 / 112 M 4b		
	1,4	M8 (5m)	4	13	109,276	2850	IRCM 103 / 112 M 4b		
	1,6	M8 (5m)	5,5	15	95,896	3440	IRCM 103 / 132 S 4c		
	1,9	M8 (5m)	5,5	18	78,692	2822	IRCM 103 / 132 S 4c		
	2,0	M8 (5m)	7,5	19	71,869	3515	IRCM 103 / 132 M 4b		
	2,5	M8 (5m)	7,5	24	58,778	2875	IRCM 103 / 132 M 4b		
	2,9	M8 (5m)	9,2	27	51,907	3114	IRCM 103 / 132 M 4c		
	0,9	M8 (5m)	3	8,6	162,826	3186	IRCM 93 / 100 L 4b		
	1,0	M8 (5m)	3	9,5	146,946	2875	IRCM 93 / 100 L 4b		
	1,1	M8 (5m)	3	10	133,419	2610	IRCM 93 / 100 L 4b		
	1,4	M7 (4m)	4	13	111,602	2911	IRCM 93 / 112 M 4b		
	1,7	M7 (4m)	5,5	16	87,936	3154	IRCM 93 / 132 S 4c		
	1,9	M7 (4m)	5,5	18	79,841	2864	IRCM 93 / 132 S 4c		
	2,2	M7 (4m)	7,5	21	66,785	3266	IRCM 93 / 132 M 4b		
	2,4	M7 (4m)	7,5	23	61,444	3005	IRCM 93 / 132 M 4b		
	2,8	M7 (4m)	9,2	26	54,545	3272	IRCM 93 / 132 M 4c		
	3,3	M6 (3m)	9,2	31	44,753	2685	IRCM 93 / 132 M 4c		
4,0	M6 (3m)	15	38	37,199	3639	IRCM 93 / 160 L 4a			
4,3	M6 (3m)	15	41	34,034	3329	IRCM 93 / 160 L 4a			
4,8	M6 (3m)	15	45	31,194	3051	IRCM 93 / 160 L 4a			
	0,8	M8 (5m)	2,2	7,0	199,476	2862	IRCM 103 / 100 L 4a		
	0,9	M8 (5m)	3	7,9	177,284	3468	IRCM 103 / 100 L 4b		
	1,1	M8 (5m)	3	10	143,552	2808	IRCM 103 / 100 L 4b		
	1,3	M8 (5m)	4	12	119,126	3107	IRCM 103 / 112 M 4b		
	1,4	M8 (5m)	4	13	109,276	2850	IRCM 103 / 112 M 4b		
	1,6	M8 (5m)	5,5	15	95,896	3440	IRCM 103 / 132 S 4c		
	2,0	M8 (5m)	5,5	18	78,692	2822	IRCM 103 / 132 S 4c		
	2,1	M8 (5m)	7,5	19	71,869	3515	IRCM 103 / 132 M 4b		
	2,6	M8 (5m)	7,5	24	58,778	2875	IRCM 103 / 132 M 4b		
	3,0	M8 (5m)	9,2	27	51,907	3114	IRCM 103 / 132 M 4c		



D _T Tambur Çapı Drum Diameter <i>Diamètre de l'arbre</i> [mm]	V _h Kaldırma Hızı Lifting Speeds <i>Vitesse de levage</i> [m/min]	Vinç Sınıfı Crane Class <i>Classification de l'application de levage</i> ISO (FEM)	P ₁ Motor Gücü Power <i>Puissance</i> [kW]	n ₂ Çıkış Devri Output Speeds <i>Vitesse de sortie</i> [r.p.m]	i Tahvil Ratio <i>Rapport de réduction</i>	M ₂ Çıkış Momenti Output Torque <i>Couple de sortie</i>	Tip Type <i>Typ</i>		 kg
Ø280	0,9	M7 (4m)	3	8,6	162,826	3186	IRCM 93 / 100 L 4b		
	1,0	M7 (4m)	3	9,5	146,946	2875	IRCM 93 / 100 L 4b		
	1,1	M7 (4m)	4	10	133,419	3480	IRCM 93 / 112 M 4b		
	1,4	M7 (4m)	4	13	111,602	2911	IRCM 93 / 112 M 4b		
	1,8	M7 (4m)	5,5	16	87,936	3154	IRCM 93 / 132 S 4c		
	2,0	M7 (4m)	5,5	18	79,841	2864	IRCM 93 / 132 S 4c		
	2,3	M7 (4m)	7,5	21	66,785	3266	IRCM 93 / 132 M 4b		
	2,5	M7 (4m)	7,5	23	61,444	3005	IRCM 93 / 132 M 4b		
	2,9	M6 (3m)	9,2	26	54,545	3272	IRCM 93 / 132 M 4c		
	3,4	M6 (3m)	11	31	44,753	3210	IRCM 93 / 160 M 4b		
	4,2	M6 (3m)	15	38	37,199	3639	IRCM 93 / 160 L 4a		
	4,5	M6 (3m)	15	41	34,034	3329	IRCM 93 / 160 L 4a		
4,9	M6 (3m)	15	45	31,194	3051	IRCM 93 / 160 L 4a			
Ø290	0,8	M8 (5m)	2,2	7,0	199,476	2862	IRCM 103 / 100 L 4a		
	0,9	M8 (5m)	3	7,9	177,284	3468	IRCM 103 / 100 L 4b		
	1,1	M8 (5m)	4	10	143,552	3745	IRCM 103 / 112 M 4b		
	1,4	M8 (5m)	4	12	119,126	3107	IRCM 103 / 112 M 4b		
	1,5	M8 (5m)	5,5	13	109,276	3919	IRCM 103 / 132 S 4c		
	1,7	M8 (5m)	5,5	15	95,896	3440	IRCM 103 / 132 S 4c		
	2,0	M8 (5m)	7,5	18	78,692	3849	IRCM 103 / 132 M 4b		
	2,2	M8 (5m)	7,5	19	71,869	3515	IRCM 103 / 132 M 4b		
	2,7	M8 (5m)	9,2	24	58,778	3526	IRCM 103 / 132 M 4c		
	3,1	M8 (5m)	9,2	27	51,907	3114	IRCM 103 / 132 M 4c		
	1,0	M7 (4m)	3	8,6	162,826	3186	IRCM 93 / 100 L 4b		
	1,1	M7 (4m)	3	9,5	146,946	2875	IRCM 93 / 100 L 4b		
	1,1	M7 (4m)	4	10	133,419	3480	IRCM 93 / 112 M 4b		
	1,5	M7 (4m)	5,5	13	111,602	4003	IRCM 93 / 132 S 4c		
	1,8	M7 (4m)	5,5	16	87,936	3154	IRCM 93 / 132 S 4c		
	2,0	M7 (4m)	7,5	18	79,841	3905	IRCM 93 / 132 M 4b		
	2,4	M6 (3m)	7,5	21	66,785	3266	IRCM 93 / 132 M 4b		
	2,6	M6 (3m)	7,5	23	61,444	3005	IRCM 93 / 132 M 4b		
	3,0	M6 (3m)	9,2	26	54,545	3272	IRCM 93 / 132 M 4c		
	3,5	M6 (3m)	11	31	44,753	3210	IRCM 93 / 160 M 4b		
4,3	M6 (3m)	15	38	37,199	3639	IRCM 93 / 160 L 4a			
4,7	M6 (3m)	15	41	34,034	3329	IRCM 93 / 160 L 4a			
5,1	M6 (3m)	15	45	31,194	3051	IRCM 93 / 160 L 4a			
0,8	M8 (5m)	3	7,0	199,476	3903	IRCM 103 / 100 L 4b			
0,9	M8 (5m)	3	7,9	177,284	3468	IRCM 103 / 100 L 4b			
1,2	M8 (5m)	4	10	143,552	3745	IRCM 103 / 112 M 4b			
1,4	M8 (5m)	4	12	119,126	3107	IRCM 103 / 112 M 4b			
1,5	M8 (5m)	5,5	13	109,276	3919	IRCM 103 / 132 S 4c			
1,8	M8 (5m)	5,5	15	95,896	3440	IRCM 103 / 132 S 4c			
2,1	M8 (5m)	7,5	18	78,692	3849	IRCM 103 / 132 M 4b			
2,2	M8 (5m)	7,5	19	71,869	3515	IRCM 103 / 132 M 4b			
2,8	M8 (5m)	9,2	24	58,778	3526	IRCM 103 / 132 M 4c			
3,2	M8 (5m)	9,2	27	51,907	3114	IRCM 103 / 132 M 4c			





D _T Tambur Çapı Drum Diameter <i>Diamètre de l'arbre</i> [mm]	V _h Kaldırma Hızı Lifting Speeds <i>Vitesse de levage</i> [m/min]	Vinç Sınıfı Crane Class <i>Classification de l'application de levage</i> ISO (FEM)	P ₁ Motor Gücü Power <i>Puissance</i> [kW]	n ₂ Çıkış Devri Output Speeds <i>Vitesse de sortie</i> [r.p.m]	i Tahvil Ratio <i>Rapport de réduction</i>	M ₂ Çıkış Momenti Output Torque <i>Couple de sortie</i>	Tip Type <i>Typ</i>		 kg
Ø300	1,0	M7 (4m)	3	8,6	162,826	3186	IRCM 93 / 100 L 4b		
	1,1	M7 (4m)	4	9,5	146,946	3833	IRCM 93 / 112 M 4b		
	1,2	M7 (4m)	4	10	133,419	3480	IRCM 93 / 112 M 4b		
	1,5	M7 (4m)	5,5	13	111,602	4003	IRCM 93 / 132 S 4c		
	1,9	M7 (4m)	5,5	16	87,936	3154	IRCM 93 / 132 S 4c		
	2,1	M6 (3m)	7,5	18	79,841	3905	IRCM 93 / 132 M 4b		
	2,5	M6 (3m)	7,5	21	66,785	3266	IRCM 93 / 132 M 4b		
	2,7	M6 (3m)	7,5	23	61,444	3005	IRCM 93 / 132 M 4b		
	3,1	M6 (3m)	9,2	26	54,545	3272	IRCM 93 / 132 M 4c		
	3,7	M6 (3m)	11	31	44,753	3210	IRCM 93 / 160 M 4b		
	4,5	M6 (3m)	15	38	37,199	3639	IRCM 93 / 160 L 4a		
	4,8	M6 (3m)	15	41	34,034	3329	IRCM 93 / 160 L 4a		
	5,3	M6 (3m)	15	45	31,194	3051	IRCM 93 / 160 L 4a		





Vinc sistemleri kaldırma redüktörleri güç ve devir tabloları / Power and ratio table for hoisting applications / Tableau de classification des couples et rapports de réduction pour les applications de levage

D _T Tambur Çapı Drum Diameter <i>Diamètre de l'arbre</i> [mm]	V _h Kaldırma Hızı Lifting Speeds <i>Vitesse de levage</i> [m/min]	Vinc Sınıfı Crane Class <i>Classification de l'application de levage</i> ISO (FEM)	P ₁ Motor Gücü Power <i>Puissance</i> [kW]	n ₂ Çıkış Devri Output Speeds <i>Vitesse de sortie</i> [r.p.m]	i Tahvil Ratio <i>Rapport de réduction</i>	M ₂ Çıkış Momenti Output Torque <i>Couple de sortie</i>	Tip Type <i>Typ</i>		 kg
Ø300	1,7	M8 (5m)	7,5	7,1	198,333	9700	IRCM 123 / 132 M 4b		
	2,0	M8 (5m)	7,5	8,7	161,000	7874	IRCM 123 / 132 M 4b		
	2,4	M7 (4m)	9,2	10	134,473	8068	IRCM 123 / 132 M 4c		
	2,8	M7 (4m)	11	12	118,333	8489	IRCM 123 / 160 M 4b		
	3,1	M7 (4m)	11	13	105,000	7532	IRCM 123 / 160 M 4b		
	3,5	M7 (4m)	15	15	93,800	9175	IRCM 123 / 160 L 4a		
	4,0	M7 (4m)	15	17	84,259	8242	IRCM 123 / 160 L 4a		
	4,5	M7 (4m)	18,5	19	73,179	8829	IRCM 123 / 180 M 4b		
	5,2	M7 (4m)	18,5	22	64,396	7769	IRCM 123 / 180 M 4b		
	5,9	M7 (4m)	22	25	57,140	8198	IRCM 123 / 180 L 4b		
	6,4	M7 (4m)	22	27	51,045	7323	IRCM 123 / 180 L 4b		
	7,3	M7 (4m)	30	31	45,853	8971	IRCM 123 / 200 L 4c		
	1,6	M6 (3m)	7,5	7,0	199,476	9756	IRCM 103 / 132 M 4b		
	1,9	M6 (3m)	7,5	7,9	177,284	8671	IRCM 103 / 132 M 4b		
	2,3	M6 (3m)	9,2	10	143,552	8613	IRCM 103 / 132 M 4c		
	2,8	M6 (3m)	11	12	119,126	8545	IRCM 103 / 160 M 4b		
	3,1	M6 (3m)	11	13	109,276	7839	IRCM 103 / 160 M 4b		
	3,5	M6 (3m)	15	15	95,896	9380	IRCM 103 / 160 L 4a		
	4,2	M6 (3m)	15	18	78,692	7698	IRCM 103 / 160 L 4a		
	4,5	M6 (3m)	18,5	19	71,869	8671	IRCM 103 / 180 M 4b		
5,7	M6 (3m)	22	24	58,778	8433	IRCM 103 / 180 L 4b			
6,4	M6 (3m)	22	27	51,907	7447	IRCM 103 / 180 L 4b			
Ø320	1,8	M7 (4m)	7,5	7,1	198,333	9700	IRCM 123 / 132 M 4b		
	2,2	M7 (4m)	9,2	8,7	161,000	9659	IRCM 123 / 132 M 4c		
	2,5	M7 (4m)	9,2	10	134,473	8068	IRCM 123 / 132 M 4c		
	3,0	M7 (4m)	11	12	118,333	8489	IRCM 123 / 160 M 4b		
	3,3	M7 (4m)	15	13	105,000	10271	IRCM 123 / 160 L 4a		
	3,8	M7 (4m)	15	15	93,800	9175	IRCM 123 / 160 L 4a		
	4,3	M7 (4m)	15	17	84,259	8242	IRCM 123 / 160 L 4a		
	4,8	M7 (4m)	18,5	19	73,179	8829	IRCM 123 / 180 M 4b		
	5,5	M7 (4m)	22	22	64,396	9239	IRCM 123 / 180 L 4b		
	6,3	M7 (4m)	22	25	57,140	8198	IRCM 123 / 180 L 4b		
	6,8	M7 (4m)	30	27	51,045	9986	IRCM 123 / 200 L 4c		
	7,8	M7 (4m)	30	31	45,853	8971	IRCM 123 / 200 L 4c		
	1,8	M6 (3m)	7,5	7,0	199,476	9756	IRCM 103 / 132 M 4b		
	2,0	M6 (3m)	7,5	7,9	177,284	8671	IRCM 103 / 132 M 4b		
	2,5	M6 (3m)	9,2	10	143,552	8613	IRCM 103 / 132 M 4c		
	3,0	M6 (3m)	11	12	119,126	8545	IRCM 103 / 160 M 4b		
	3,3	M6 (3m)	15	13	109,276	10689	IRCM 103 / 160 L 4a		
	3,8	M6 (3m)	15	15	95,896	9380	IRCM 103 / 160 L 4a		
	4,5	M6 (3m)	18,5	18	78,692	9494	IRCM 103 / 180 M 4b		
	4,8	M6 (3m)	18,5	19	71,869	8671	IRCM 103 / 180 M 4b		
6,0	M6 (3m)	22	24	58,778	8433	IRCM 103 / 180 L 4b			
6,8	M5 (2m)	30	27	51,907	10155	IRCM 103 / 200 L 4c			
Ø340	1,9	M7 (4m)	7,5	7,1	198,333	9700	IRCM 123 / 132 M 4b		
	2,3	M7 (4m)	9,2	8,7	161,000	9659	IRCM 123 / 132 M 4c		
	2,7	M7 (4m)	9,2	10	134,473	8068	IRCM 123 / 132 M 4c		
	3,2	M7 (4m)	15	12	118,333	11575	IRCM 123 / 160 L 4a		
	3,5	M7 (4m)	15	13	105,000	10271	IRCM 123 / 160 L 4a		
	4,0	M7 (4m)	15	15	93,800	9175	IRCM 123 / 160 L 4a		
	4,5	M7 (4m)	18,5	17	84,259	10165	IRCM 123 / 180 M 4b		
	5,1	M7 (4m)	18,5	19	73,179	8829	IRCM 123 / 180 M 4b		
	5,9	M7 (4m)	22	22	64,396	9239	IRCM 123 / 180 L 4b		
	6,7	M7 (4m)	30	25	57,140	11179	IRCM 123 / 200 L 4c		
	7,2	M7 (4m)	30	27	51,045	9986	IRCM 123 / 200 L 4c		
	8,3	M7 (4m)	30	31	45,853	8971	IRCM 123 / 200 L 4c		



D _T Tambur Çapı Drum Diameter <i>Diamètre de l'arbre</i> [mm]	V _h Kaldırma Hızı Lifting Speeds <i>Vitesse de levage</i> [m/min]	Vinç Sınıfı Crane Class <i>Classification de l'application de levage</i> ISO (FEM)	P ₁ Motor Gücü Power <i>Puissance</i> [kW]	n ₂ Çıkış Devri Output Speeds <i>Vitesse de sortie</i> [r.p.m]	i Tahvil Ratio <i>Rapport de réduction</i>	M ₂ Çıkış Momenti Output Torque <i>Couple de sortie</i>	Tip Type <i>Typ</i>		 kg
Ø360	2,0	M7 (4m)	7,5	7,1	198,333	9700	IRCM 123 / 132 M 4b		
	2,5	M7 (4m)	9,2	8,7	161,000	9659	IRCM 123 / 132 M 4c		
	2,8	M7 (4m)	11	10	134,473	9646	IRCM 123 / 160 M 4b		
	3,4	M7 (4m)	15	12	118,333	11575	IRCM 123 / 160 L 4a		
	3,7	M7 (4m)	15	13	105,000	10271	IRCM 123 / 160 L 4a		
	4,2	M7 (4m)	15	15	93,800	9175	IRCM 123 / 160 L 4a		
	4,8	M7 (4m)	18,5	17	84,259	10165	IRCM 123 / 180 M 4b		
	5,4	M7 (4m)	18,5	19	73,179	8829	IRCM 123 / 180 M 4b		
	6,2	M7 (4m)	22	22	64,396	9239	IRCM 123 / 180 L 4b		
	7,1	M7 (4m)	30	25	57,140	11179	IRCM 123 / 200 L 4c		
	7,6	M7 (4m)	30	27	51,045	9986	IRCM 123 / 200 L 4c		
	8,8	M7 (4m)	37	31	45,853	11064	IRCM 123 / 225 S 4a		
Ø380	2,1	M7 (4m)	7,5	7,1	198,333	9700	IRCM 123 / 132 M 4b		
	2,6	M7 (4m)	9,2	8,7	161,000	9659	IRCM 123 / 132 M 4c		
	3,0	M6 (3m)	11	10	134,473	9646	IRCM 123 / 160 M 4b		
	3,6	M6 (3m)	15	12	118,333	11575	IRCM 123 / 160 L 4a		
	3,9	M6 (3m)	15	13	105,000	10271	IRCM 123 / 160 L 4a		
	4,5	M6 (3m)	18,5	15	93,800	11316	IRCM 123 / 180 M 4b		
	5,1	M6 (3m)	18,5	17	84,259	10165	IRCM 123 / 180 M 4b		
	5,7	M6 (3m)	22	19	73,179	10499	IRCM 123 / 180 L 4b		
	6,6	M6 (3m)	30	22	64,396	12598	IRCM 123 / 200 L 4c		
	7,5	M6 (3m)	30	25	57,140	11179	IRCM 123 / 200 L 4c		
	8,1	M6 (3m)	30	27	51,045	9986	IRCM 123 / 200 L 4c		
	9,2	M6 (3m)	37	31	45,853	11064	IRCM 123 / 225 S 4a		
Ø400	2,2	M6 (3m)	9,2	7,1	198,333	11899	IRCM 123 / 132 M 4c		
	2,7	M6 (3m)	11	8,7	161,000	11549	IRCM 123 / 160 M 4b		
	3,1	M6 (3m)	11	10	134,473	9646	IRCM 123 / 160 M 4b		
	3,8	M6 (3m)	15	12	118,333	11575	IRCM 123 / 160 L 4a		
	4,1	M6 (3m)	15	13	105,000	10271	IRCM 123 / 160 L 4a		
	4,7	M6 (3m)	18,5	15	93,800	11316	IRCM 123 / 180 M 4b		
	5,3	M6 (3m)	18,5	17	84,259	10165	IRCM 123 / 180 M 4b		
	6,0	M6 (3m)	22	19	73,179	10499	IRCM 123 / 180 L 4b		
	6,9	M6 (3m)	30	22	64,396	12598	IRCM 123 / 200 L 4c		
	7,9	M6 (3m)	30	25	57,140	11179	IRCM 123 / 200 L 4c		
	8,5	M6 (3m)	30	27	51,045	9986	IRCM 123 / 200 L 4c		
	9,7	M6 (3m)	37	31	45,853	11064	IRCM 123 / 225 S 4a		
Ø420	2,3	M6 (3m)	9,2	7,1	198,333	11899	IRCM 123 / 132 M 4c		
	2,9	M6 (3m)	11	8,7	161,000	11549	IRCM 123 / 160 M 4b		
	3,3	M6 (3m)	15	10	134,473	13154	IRCM 123 / 160 L 4a		
	4,0	M6 (3m)	15	12	118,333	11575	IRCM 123 / 160 L 4a		
	4,3	M6 (3m)	15	13	105,000	10271	IRCM 123 / 160 L 4a		
	4,9	M6 (3m)	18,5	15	93,800	11316	IRCM 123 / 180 M 4b		
	5,6	M6 (3m)	22	17	84,259	12088	IRCM 123 / 180 L 4b		
	6,3	M6 (3m)	22	19	73,179	10499	IRCM 123 / 180 L 4b		
	7,3	M6 (3m)	30	22	64,396	12598	IRCM 123 / 200 L 4c		
	8,2	M6 (3m)	30	25	57,140	11179	IRCM 123 / 200 L 4c		
	8,9	M6 (3m)	37	27	51,045	12317	IRCM 123 / 225 S 4a		
	10	M6 (3m)	37	31	45,853	11064	IRCM 123 / 225 S 4a		



D _T Tambur Çapı Drum Diameter <i>Diamètre de l'arbre</i> [mm]	V _h Kaldırma Hızı Lifting Speeds <i>Vitesse de levage</i> [m/min]	Vinç Sınıfı Crane Class <i>Classification de l'application de levage</i> ISO (FEM)	P ₁ Motor Gücü Power <i>Puissance</i> [kW]	n ₂ Çıkış Devri Output Speeds <i>Vitesse de sortie</i> [r.p.m]	i Tahvil Ratio <i>Rapport de réduction</i>	M ₂ Çıkış Momenti Output Torque <i>Couple de sortie</i>	Tip Type <i>Typ</i>		 kg
Ø440	2,5	M6 (3m)	9,2	7,1	198,333	11899	IRCM 123 / 132 M 4c		
	3,0	M6 (3m)	11	8,7	161,000	11549	IRCM 123 / 160 M 4b		
	3,5	M6 (3m)	15	10	134,473	13154	IRCM 123 / 160 L 4a		
	4,1	M6 (3m)	15	12	118,333	11575	IRCM 123 / 160 L 4a		
	4,5	M6 (3m)	18,5	13	105,000	12668	IRCM 123 / 180 M 4b		
	5,2	M6 (3m)	18,5	15	93,800	11316	IRCM 123 / 180 M 4b		
	5,9	M6 (3m)	22	17	84,259	12088	IRCM 123 / 180 L 4b		
	6,6	M6 (3m)	30	19	73,179	14317	IRCM 123 / 200 L 4c		
	7,6	M6 (3m)	30	22	64,396	12598	IRCM 123 / 200 L 4c		
	8,6	M6 (3m)	30	25	57,140	11179	IRCM 123 / 200 L 4c		
	9,3	M6 (3m)	37	27	51,045	12317	IRCM 123 / 225 S 4a		
11	M6 (3m)	37	31	45,853	11064	IRCM 123 / 225 S 4a			





D _T Tambur Çapı Drum Diameter <i>Diamètre de l'arbre</i> [mm]	V _h Kaldırma Hızı Lifting Speeds <i>Vitesse de levage</i> [m/min]	Vinç Sınıfı Crane Class <i>Classification de l'application de levage</i> ISO (FEM)	P ₁ Motor Gücü Power <i>Puissance</i> [kW]	n ₂ Çıkış Devri Output Speeds <i>Vitesse de sortie</i> [r.p.m]	i Tahvil Ratio <i>Rapport de réduction</i>	M ₂ Çıkış Momenti Output Torque <i>Couple de sortie</i>	Tip Type <i>Typ</i>		 kg
Ø270	1,0	M8 (5m)	4	7,1	198,333	5174	IRCM 123 / 112 M 4b		
	1,2	M8 (5m)	5,5	8,7	161,000	5775	IRCM 123 / 132 S 4c		
	1,4	M8 (5m)	5,5	10	134,473	4823	IRCM 123 / 132 S 4c		
	1,7	M8 (5m)	7,5	12	118,333	5788	IRCM 123 / 132 M 4b		
	1,8	M8 (5m)	7,5	13	105,000	5136	IRCM 123 / 132 M 4b		
	2,1	M8 (5m)	7,5	15	93,800	4588	IRCM 123 / 132 M 4b		
	2,4	M8 (5m)	9,2	17	84,259	5055	IRCM 123 / 132 M 4c		
	2,7	M8 (5m)	11	19	73,179	5249	IRCM 123 / 160 M 4b		
	3,1	M8 (5m)	11	22	64,396	4619	IRCM 123 / 160 M 4b		
	3,5	M8 (5m)	15	25	57,140	5589	IRCM 123 / 160 L 4a		
	3,8	M8 (5m)	15	27	51,045	4993	IRCM 123 / 160 L 4a		
	4,4	M8 (5m)	18,5	31	45,853	5532	IRCM 123 / 180 M 4b		
	1,0	M8 (5m)	4	7,0	199,476	5203	IRCM 103 / 112 M 4b		
	1,1	M8 (5m)	4	7,9	177,284	4624	IRCM 103 / 112 M 4b		
	1,4	M8 (5m)	5,5	10	143,552	5149	IRCM 103 / 132 S 4c		
	1,7	M8 (5m)	7,5	12	119,126	5826	IRCM 103 / 132 M 4b		
	1,8	M8 (5m)	7,5	13	109,276	5345	IRCM 103 / 132 M 4b		
	2,1	M8 (5m)	7,5	15	95,896	4690	IRCM 103 / 132 M 4b		
	2,5	M8 (5m)	9,2	18	78,692	4721	IRCM 103 / 132 M 4c		
	2,7	M8 (5m)	11	19	71,869	5155	IRCM 103 / 160 M 4b		
3,4	M8 (5m)	15	24	58,778	5750	IRCM 103 / 160 L 4a			
3,8	M8 (5m)	15	27	51,907	5078	IRCM 103 / 160 L 4a			
Ø280	1,0	M8 (5m)	4	7,1	198,333	5174	IRCM 123 / 112 M 4b		
	1,3	M8 (5m)	5,5	8,7	161,000	5775	IRCM 123 / 132 S 4c		
	1,5	M8 (5m)	5,5	10	134,473	4823	IRCM 123 / 132 S 4c		
	1,8	M8 (5m)	7,5	12	118,333	5788	IRCM 123 / 132 M 4b		
	1,9	M8 (5m)	7,5	13	105,000	5136	IRCM 123 / 132 M 4b		
	2,2	M8 (5m)	9,2	15	93,800	5628	IRCM 123 / 132 M 4c		
	2,5	M8 (5m)	9,2	17	84,259	5055	IRCM 123 / 132 M 4c		
	2,8	M8 (5m)	11	19	73,179	5249	IRCM 123 / 160 M 4b		
	3,2	M8 (5m)	15	22	64,396	6299	IRCM 123 / 160 L 4a		
	3,7	M8 (5m)	15	25	57,140	5589	IRCM 123 / 160 L 4a		
	4,0	M8 (5m)	15	27	51,045	4993	IRCM 123 / 160 L 4a		
	4,5	M8 (5m)	18,5	31	45,853	5532	IRCM 123 / 180 M 4b		
	1,0	M8 (5m)	4	7,0	199,476	5203	IRCM 103 / 112 M 4b		
	1,2	M8 (5m)	4	7,9	177,284	4624	IRCM 103 / 112 M 4b		
	1,4	M8 (5m)	5,5	10	143,552	5149	IRCM 103 / 132 S 4c		
	1,8	M8 (5m)	7,5	12	119,126	5826	IRCM 103 / 132 M 4b		
	1,9	M8 (5m)	7,5	13	109,276	5345	IRCM 103 / 132 M 4b		
	2,2	M8 (5m)	9,2	15	95,896	5753	IRCM 103 / 132 M 4c		
	2,6	M8 (5m)	9,2	18	78,692	4721	IRCM 103 / 132 M 4c		
	2,8	M8 (5m)	11	19	71,869	5155	IRCM 103 / 160 M 4b		
3,5	M8 (5m)	15	24	58,778	5750	IRCM 103 / 160 L 4a			
4,0	M8 (5m)	15	27	51,907	5078	IRCM 103 / 160 L 4a			
Ø290	1,1	M8 (5m)	4	7,1	198,333	5174	IRCM 123 / 112 M 4b		
	1,3	M8 (5m)	5,5	8,7	161,000	5775	IRCM 123 / 132 S 4c		
	1,5	M8 (5m)	5,5	10	134,473	4823	IRCM 123 / 132 S 4c		
	1,8	M8 (5m)	7,5	12	118,333	5788	IRCM 123 / 132 M 4b		
	2,0	M8 (5m)	7,5	13	105,000	5136	IRCM 123 / 132 M 4b		
	2,3	M8 (5m)	9,2	15	93,800	5628	IRCM 123 / 132 M 4c		
	2,6	M8 (5m)	9,2	17	84,259	5055	IRCM 123 / 132 M 4c		
	2,9	M8 (5m)	11	19	73,179	5249	IRCM 123 / 160 M 4b		
	3,3	M8 (5m)	15	22	64,396	6299	IRCM 123 / 160 L 4a		
	3,8	M8 (5m)	15	25	57,140	5589	IRCM 123 / 160 L 4a		
	4,1	M8 (5m)	15	27	51,045	4993	IRCM 123 / 160 L 4a		
	4,7	M8 (5m)	18,5	31	45,853	5532	IRCM 123 / 180 M 4b		



Vinç sistemleri kaldırma redüktörleri güç ve devir tabloları / Power and ratio table for hoisting applications / Tableau de classification des couples et rapports de réduction pour les applications de levage

D _T Tambur Çapı Drum Diameter <i>Diamètre de l'arbre</i> [mm]	V _h Kaldırma Hızı Lifting Speeds <i>Vitesse de levage</i> [m/min]	Vinç Sınıfı Crane Class <i>Classification de l'application de levage</i> ISO (FEM)	P ₁ Motor Gücü Power <i>Puissance</i> [kW]	n ₂ Çıkış Devri Output Speeds <i>Vitesse de sortie</i> [r.p.m]	i Tahvil Ratio <i>Rapport de réduction</i>	M ₂ Çıkış Momenti Output Torque <i>Couple de sortie</i>	Tip Type <i>Typ</i>		 kg
Ø300	1,1	M8 (5m)	4	7,1	198,333	5174	IRCM 123 / 112 M 4b		
	1,4	M8 (5m)	5,5	8,7	161,000	5775	IRCM 123 / 132 S 4c		
	1,6	M8 (5m)	5,5	10	134,473	4823	IRCM 123 / 132 S 4c		
	1,9	M8 (5m)	7,5	12	118,333	5788	IRCM 123 / 132 M 4b		
	2,0	M8 (5m)	7,5	13	105,000	5136	IRCM 123 / 132 M 4b		
	2,4	M8 (5m)	9,2	15	93,800	5628	IRCM 123 / 132 M 4c		
	2,7	M8 (5m)	9,2	17	84,259	5055	IRCM 123 / 132 M 4c		
	3,0	M8 (5m)	11	19	73,179	5249	IRCM 123 / 160 M 4b		
	3,5	M8 (5m)	15	22	64,396	6299	IRCM 123 / 160 L 4a		
	3,9	M8 (5m)	15	25	57,140	5589	IRCM 123 / 160 L 4a		
	4,2	M8 (5m)	15	27	51,045	4993	IRCM 123 / 160 L 4a		
	4,9	M8 (5m)	18,5	31	45,853	5532	IRCM 123 / 180 M 4b		
	1,1	M8 (5m)	4	7,0	199,476	5203	IRCM 103 / 112 M 4b		
	1,2	M8 (5m)	5,5	7,9	177,284	6359	IRCM 103 / 132 S 4c		
	1,5	M8 (5m)	5,5	10	143,552	5149	IRCM 103 / 132 S 4c		
	1,9	M8 (5m)	7,5	12	119,126	5826	IRCM 103 / 132 M 4b		
	2,0	M8 (5m)	7,5	13	109,276	5345	IRCM 103 / 132 M 4b		
	2,4	M8 (5m)	9,2	15	95,896	5753	IRCM 103 / 132 M 4c		
	2,8	M8 (5m)	11	18	78,692	5645	IRCM 103 / 160 M 4b		
	3,0	M8 (5m)	11	19	71,869	5155	IRCM 103 / 160 M 4b		
3,8	M8 (5m)	15	24	58,778	5750	IRCM 103 / 160 L 4a			
4,2	M7 (4m)	15	27	51,907	5078	IRCM 103 / 160 L 4a			
Ø320	1,2	M8 (5m)	5,5	7,1	198,333	7114	IRCM 123 / 132 S 4c		
	1,5	M8 (5m)	5,5	8,7	161,000	5775	IRCM 123 / 132 S 4c		
	1,7	M8 (5m)	7,5	10	134,473	6577	IRCM 123 / 132 M 4b		
	2,0	M8 (5m)	7,5	12	118,333	5788	IRCM 123 / 132 M 4b		
	2,2	M8 (5m)	7,5	13	105,000	5136	IRCM 123 / 132 M 4b		
	2,5	M8 (5m)	9,2	15	93,800	5628	IRCM 123 / 132 M 4c		
	2,8	M8 (5m)	11	17	84,259	6044	IRCM 123 / 160 M 4b		
	3,2	M8 (5m)	11	19	73,179	5249	IRCM 123 / 160 M 4b		
	3,7	M8 (5m)	15	22	64,396	6299	IRCM 123 / 160 L 4a		
	4,2	M8 (5m)	15	25	57,140	5589	IRCM 123 / 160 L 4a		
	4,5	M8 (5m)	18,5	27	51,045	6158	IRCM 123 / 180 M 4b		
	5,2	M8 (5m)	18,5	31	45,853	5532	IRCM 123 / 180 M 4b		
	1,2	M8 (5m)	5,5	7,0	199,476	7155	IRCM 103 / 132 S 4c		
	1,3	M8 (5m)	5,5	7,9	177,284	6359	IRCM 103 / 132 S 4c		
	1,6	M8 (5m)	7,5	10	143,552	7021	IRCM 103 / 132 M 4b		
	2,0	M8 (5m)	7,5	12	119,126	5826	IRCM 103 / 132 M 4b		
	2,2	M8 (5m)	7,5	13	109,276	5345	IRCM 103 / 132 M 4b		
	2,5	M8 (5m)	9,2	15	95,896	5753	IRCM 103 / 132 M 4c		
	3,0	M8 (5m)	11	18	78,692	5645	IRCM 103 / 160 M 4b		
	3,2	M8 (5m)	11	19	71,869	5155	IRCM 103 / 160 M 4b		
4,0	M7 (4m)	15	24	58,778	5750	IRCM 103 / 160 L 4a			
4,5	M7 (4m)	18,5	27	51,907	6262	IRCM 103 / 180 M 4b			
Ø340	1,3	M8 (5m)	5,5	7,1	198,333	7114	IRCM 123 / 132 S 4c		
	1,5	M8 (5m)	5,5	8,7	161,000	5775	IRCM 123 / 132 S 4c		
	1,8	M8 (5m)	7,5	10	134,473	6577	IRCM 123 / 132 M 4b		
	2,1	M8 (5m)	7,5	12	118,333	5788	IRCM 123 / 132 M 4b		
	2,3	M8 (5m)	9,2	13	105,000	6300	IRCM 123 / 132 M 4c		
	2,7	M8 (5m)	9,2	15	93,800	5628	IRCM 123 / 132 M 4c		
	3,0	M8 (5m)	11	17	84,259	6044	IRCM 123 / 160 M 4b		
	3,4	M8 (5m)	15	19	73,179	7158	IRCM 123 / 160 L 4a		
	3,9	M8 (5m)	15	22	64,396	6299	IRCM 123 / 160 L 4a		
	4,4	M8 (5m)	18,5	25	57,140	6894	IRCM 123 / 180 M 4b		
	4,8	M8 (5m)	18,5	27	51,045	6158	IRCM 123 / 180 M 4b		
	5,5	M8 (5m)	22	31	45,853	6578	IRCM 123 / 180 L 4b		





D _T Tambur Çapı Drum Diameter <i>Diamètre de l'arbre</i> [mm]	V _h Kaldırma Hızı Lifting Speeds <i>Vitesse de levage</i> [m/min]	Vinç Sınıfı Crane Class <i>Classification de l'application de levage</i> ISO (FEM)	P ₁ Motor Gücü Power <i>Puissance</i> [kW]	n ₂ Çıkış Devri Output Speeds <i>Vitesse de sortie</i> [r.p.m]	i Tahvil Ratio <i>Rapport de réduction</i>	M ₂ Çıkış Momenti Output Torque <i>Couple de sortie</i>	Tip Type <i>Typ</i>		 kg
Ø360	1,2	M7 (4m)	5,5	7,0	199,476	7155	IRCM 103 / 132 S 4c		
	1,4	M7 (4m)	5,5	7,9	177,284	6359	IRCM 103 / 132 S 4c		
	1,7	M7 (4m)	7,5	10	143,552	7021	IRCM 103 / 132 M 4b		
	2,1	M7 (4m)	7,5	12	119,126	5826	IRCM 103 / 132 M 4b		
	2,3	M7 (4m)	9,2	13	109,276	6556	IRCM 103 / 132 M 4c		
	2,7	M7 (4m)	9,2	15	95,896	5753	IRCM 103 / 132 M 4c		
	3,2	M7 (4m)	15	18	78,692	7698	IRCM 103 / 160 L 4a		
	3,4	M7 (4m)	15	19	71,869	7030	IRCM 103 / 160 L 4a		
	4,3	M7 (4m)	15	24	58,778	5750	IRCM 103 / 160 L 4a		
	4,8	M7 (4m)	18,5	27	51,907	6262	IRCM 103 / 180 M 4b		
Ø360	1,3	M8 (5m)	5,5	7,1	198,333	7114	IRCM 123 / 132 S 4c		
	1,6	M8 (5m)	7,5	8,7	161,000	7874	IRCM 123 / 132 M 4b		
	1,9	M8 (5m)	7,5	10	134,473	6577	IRCM 123 / 132 M 4b		
	2,3	M8 (5m)	9,2	12	118,333	7099	IRCM 123 / 132 M 4c		
	2,4	M8 (5m)	9,2	13	105,000	6300	IRCM 123 / 132 M 4c		
	2,8	M8 (5m)	11	15	93,800	6729	IRCM 123 / 160 M 4b		
	3,2	M8 (5m)	15	17	84,259	8242	IRCM 123 / 160 L 4a		
	3,6	M8 (5m)	15	19	73,179	7158	IRCM 123 / 160 L 4a		
	4,1	M8 (5m)	15	22	64,396	6299	IRCM 123 / 160 L 4a		
	4,7	M8 (5m)	18,5	25	57,140	6894	IRCM 123 / 180 M 4b		
	5,1	M8 (5m)	18,5	27	51,045	6158	IRCM 123 / 180 M 4b		
	5,8	M8 (5m)	22	31	45,853	6578	IRCM 123 / 180 L 4b		
	1,3	M7 (4m)	5,5	7,0	199,476	7155	IRCM 103 / 132 S 4c		
	1,5	M7 (4m)	5,5	7,9	177,284	6359	IRCM 103 / 132 S 4c		
	1,8	M7 (4m)	7,5	10	143,552	7021	IRCM 103 / 132 M 4b		
	2,3	M7 (4m)	9,2	12	119,126	7147	IRCM 103 / 132 M 4c		
	2,4	M7 (4m)	9,2	13	109,276	6556	IRCM 103 / 132 M 4c		
	2,8	M7 (4m)	11	15	95,896	6879	IRCM 103 / 160 M 4b		
3,4	M7 (4m)	15	18	78,692	7698	IRCM 103 / 160 L 4a			
3,6	M7 (4m)	15	19	71,869	7030	IRCM 103 / 160 L 4a			
4,5	M7 (4m)	18,5	24	58,778	7091	IRCM 103 / 180 M 4b			
5,1	M7 (4m)	18,5	27	51,907	6262	IRCM 103 / 180 M 4b			
Ø380	1,4	M8 (5m)	5,5	7,1	198,333	7114	IRCM 123 / 132 S 4c		
	1,7	M8 (5m)	7,5	8,7	161,000	7874	IRCM 123 / 132 M 4b		
	2,0	M8 (5m)	7,5	10	134,473	6577	IRCM 123 / 132 M 4b		
	2,4	M8 (5m)	9,2	12	118,333	7099	IRCM 123 / 132 M 4c		
	2,6	M8 (5m)	9,2	13	105,000	6300	IRCM 123 / 132 M 4c		
	3,0	M8 (5m)	11	15	93,800	6729	IRCM 123 / 160 M 4b		
	3,4	M8 (5m)	15	17	84,259	8242	IRCM 123 / 160 L 4a		
	3,8	M8 (5m)	15	19	73,179	7158	IRCM 123 / 160 L 4a		
	4,4	M8 (5m)	18,5	22	64,396	7769	IRCM 123 / 180 M 4b		
	5,0	M8 (5m)	18,5	25	57,140	6894	IRCM 123 / 180 M 4b		
	5,4	M8 (5m)	18,5	27	51,045	6158	IRCM 123 / 180 M 4b		
	6,2	M8 (5m)	22	31	45,853	6578	IRCM 123 / 180 L 4b		
	1,4	M7 (4m)	5,5	7,0	199,476	7155	IRCM 103 / 132 S 4c		
	1,6	M7 (4m)	5,5	7,9	177,284	6359	IRCM 103 / 132 S 4c		
	1,9	M7 (4m)	7,5	10	143,552	7021	IRCM 103 / 132 M 4b		
	2,4	M7 (4m)	9,2	12	119,126	7147	IRCM 103 / 132 M 4c		
	2,6	M7 (4m)	9,2	13	109,276	6556	IRCM 103 / 132 M 4c		
	3,0	M7 (4m)	11	15	95,896	6879	IRCM 103 / 160 M 4b		
	3,6	M7 (4m)	15	18	78,692	7698	IRCM 103 / 160 L 4a		
	3,8	M7 (4m)	15	19	71,869	7030	IRCM 103 / 160 L 4a		
4,8	M7 (4m)	18,5	24	58,778	7091	IRCM 103 / 180 M 4b			
5,4	M6 (3m)	18,5	27	51,907	6262	IRCM 103 / 180 M 4b			



Vinç sistemleri kaldırma redüktörleri güç ve devir tabloları / Power and ratio table for hoisting applications / Tableau de classification des couples et rapports de réduction pour les applications de levage



D _T Tambur Çapı Drum Diameter <i>Diamètre de l'arbre</i> [mm]	V _h Kaldırma Hızı Lifting Speeds <i>Vitesse de levage</i> [m/min]	Vinç Sınıfı Crane Class <i>Classification de l'application de levage</i> ISO (FEM)	P ₁ Motor Gücü Power <i>Puissance</i> [kW]	n ₂ Çıkış Devri Output Speeds <i>Vitesse de sortie</i> [r.p.m]	i Tahvil Ratio <i>Rapport de réduction</i>	M ₂ Çıkış Momenti Output Torque <i>Couple de sortie</i>	Tip Type <i>Typ</i>		 kg
Ø270	0,7	M8 (5m)	3	7,0	199,476	3903	IRCM 103 / 100 L 4b		
	0,8	M8 (5m)	3	7,9	177,284	3468	IRCM 103 / 100 L 4b		
	1,0	M8 (5m)	4	10	143,552	3745	IRCM 103 / 112 M 4b		
	1,3	M8 (5m)	5,5	12	119,126	4273	IRCM 103 / 132 S 4c		
	1,4	M8 (5m)	5,5	13	109,276	3919	IRCM 103 / 132 S 4c		
	1,6	M8 (5m)	5,5	15	95,896	3440	IRCM 103 / 132 S 4c		
	1,9	M8 (5m)	7,5	18	78,692	3849	IRCM 103 / 132 M 4b		
	2,0	M8 (5m)	7,5	19	71,869	3515	IRCM 103 / 132 M 4b		
	2,5	M8 (5m)	9,2	24	58,778	3526	IRCM 103 / 132 M 4c		
	2,9	M8 (5m)	11	27	51,907	3724	IRCM 103 / 160 M 4b		
	0,9	M7 (4m)	4	8,6	162,826	4247	IRCM 93 / 112 M 4b		
	1,0	M7 (4m)	4	9,5	146,946	3833	IRCM 93 / 112 M 4b		
	1,1	M6 (3m)	4	10	133,419	3480	IRCM 93 / 112 M 4b		
	1,4	M6 (3m)	5,5	13	111,602	4003	IRCM 93 / 132 S 4c		
	1,7	M6 (3m)	7,5	16	87,936	4301	IRCM 93 / 132 M 4b		
	1,9	M6 (3m)	7,5	18	79,841	3905	IRCM 93 / 132 M 4b		
	2,2	M6 (3m)	9,2	21	66,785	4007	IRCM 93 / 132 M 4c		
	2,4	M6 (3m)	9,2	23	61,444	3686	IRCM 93 / 132 M 4c		
	2,8	M5 (2m)	11	26	54,545	3913	IRCM 93 / 160 M 4b		
	3,3	M5 (2m)	15	31	44,753	4378	IRCM 93 / 160 L 4a		
4,0	M5 (2m)	15	38	37,199	3639	IRCM 93 / 160 L 4a			
4,3	M5 (2m)	15	41	34,034	3329	IRCM 93 / 160 L 4a			
4,8	M5 (2m)	18,5	45	31,194	3763	IRCM 93 / 180 M 4b			
Ø280	0,8	M8 (5m)	3	7,0	199,476	3903	IRCM 103 / 100 L 4b		
	0,9	M8 (5m)	3	7,9	177,284	3468	IRCM 103 / 100 L 4b		
	1,1	M8 (5m)	4	10	143,552	3745	IRCM 103 / 112 M 4b		
	1,3	M8 (5m)	5,5	12	119,126	4273	IRCM 103 / 132 S 4c		
	1,4	M8 (5m)	5,5	13	109,276	3919	IRCM 103 / 132 S 4c		
	1,6	M8 (5m)	7,5	15	95,896	4690	IRCM 103 / 132 M 4b		
	2,0	M8 (5m)	7,5	18	78,692	3849	IRCM 103 / 132 M 4b		
	2,1	M8 (5m)	7,5	19	71,869	3515	IRCM 103 / 132 M 4b		
	2,6	M8 (5m)	9,2	24	58,778	3526	IRCM 103 / 132 M 4c		
	3,0	M8 (5m)	11	27	51,907	3724	IRCM 103 / 160 M 4b		
	0,9	M6 (3m)	4	8,6	162,826	4247	IRCM 93 / 112 M 4b		
	1,0	M6 (3m)	4	9,5	146,946	3833	IRCM 93 / 112 M 4b		
	1,1	M6 (3m)	4	10	133,419	3480	IRCM 93 / 112 M 4b		
	1,4	M6 (3m)	5,5	13	111,602	4003	IRCM 93 / 132 S 4c		
	1,8	M6 (3m)	7,5	16	87,936	4301	IRCM 93 / 132 M 4b		
	2,0	M6 (3m)	7,5	18	79,841	3905	IRCM 93 / 132 M 4b		
	2,3	M6 (3m)	9,2	21	66,785	4007	IRCM 93 / 132 M 4c		
	2,5	M6 (3m)	9,2	23	61,444	3686	IRCM 93 / 132 M 4c		
	2,9	M5 (2m)	11	26	54,545	3913	IRCM 93 / 160 M 4b		
	3,4	M5 (2m)	15	31	44,753	4378	IRCM 93 / 160 L 4a		
4,2	M5 (2m)	15	38	37,199	3639	IRCM 93 / 160 L 4a			
4,5	M5 (2m)	18,5	41	34,034	4106	IRCM 93 / 180 M 4b			
4,9	M5 (2m)	18,5	45	31,194	3763	IRCM 93 / 180 M 4b			
	0,8	M8 (5m)	3	7,0	199,476	3903	IRCM 103 / 100 L 4b		
	0,9	M8 (5m)	4	7,9	177,284	4624	IRCM 103 / 112 M 4b		
	1,1	M8 (5m)	4	10	143,552	3745	IRCM 103 / 112 M 4b		
	1,4	M8 (5m)	5,5	12	119,126	4273	IRCM 103 / 132 S 4c		
	1,5	M8 (5m)	5,5	13	109,276	3919	IRCM 103 / 132 S 4c		
	1,7	M8 (5m)	7,5	15	95,896	4690	IRCM 103 / 132 M 4b		
	2,0	M8 (5m)	7,5	18	78,692	3849	IRCM 103 / 132 M 4b		
	2,2	M8 (5m)	7,5	19	71,869	3515	IRCM 103 / 132 M 4b		
	2,7	M8 (5m)	11	24	58,778	4216	IRCM 103 / 160 M 4b		
	3,1	M8 (5m)	11	27	51,907	3724	IRCM 103 / 160 M 4b		





D _T Tambur Çapı Drum Diameter <i>Diamètre de l'arbre</i> [mm]	V _h Kaldırma Hızı Lifting Speeds <i>Vitesse de levage</i> [m/min]	Vinç Sınıfı Crane Class <i>Classification de l'application de levage</i> ISO (FEM)	P ₁ Motor Gücü Power <i>Puissance</i> [kW]	n ₂ Çıkış Devri Output Speeds <i>Vitesse de sortie</i> [r.p.m]	i Tahvil Ratio <i>Rapport de réduction</i>	M ₂ Çıkış Momenti Output Torque <i>Couple de sortie</i>	Tip Type <i>Typ</i>		 kg
Ø290	1,0	M6 (3m)	4	8,6	162,826	4247	IRCM 93 / 112 M 4b		
	1,1	M6 (3m)	4	9,5	146,946	3833	IRCM 93 / 112 M 4b		
	1,1	M6 (3m)	4	10	133,419	3480	IRCM 93 / 112 M 4b		
	1,5	M6 (3m)	5,5	13	111,602	4003	IRCM 93 / 132 S 4c		
	1,8	M6 (3m)	7,5	16	87,936	4301	IRCM 93 / 132 M 4b		
	2,0	M6 (3m)	7,5	18	79,841	3905	IRCM 93 / 132 M 4b		
	2,4	M5 (2m)	9,2	21	66,785	4007	IRCM 93 / 132 M 4c		
	2,6	M5 (2m)	9,2	23	61,444	3686	IRCM 93 / 132 M 4c		
	3,0	M5 (2m)	11	26	54,545	3913	IRCM 93 / 160 M 4b		
	3,5	M4 (1Am)	15	31	44,753	4378	IRCM 93 / 160 L 4a		
	4,3	M4 (1Am)	15	38	37,199	3639	IRCM 93 / 160 L 4a		
	4,7	M4 (1Am)	18,5	41	34,034	4106	IRCM 93 / 180 M 4b		
	5,1	M4 (1Am)	18,5	45	31,194	3763	IRCM 93 / 180 M 4b		
Ø300	0,8	M8 (5m)	3	7,1	198,333	3880	IRCM 123 / 100 L 4b		
	1,0	M8 (5m)	4	8,7	161,000	4200	IRCM 123 / 112 M 4b		
	1,2	M8 (5m)	5,5	10	134,473	4823	IRCM 123 / 132 S 4c		
	1,4	M8 (5m)	5,5	12	118,333	4244	IRCM 123 / 132 S 4c		
	1,5	M8 (5m)	5,5	13	105,000	3766	IRCM 123 / 132 S 4c		
	1,8	M8 (5m)	7,5	15	93,800	4588	IRCM 123 / 132 M 4b		
	2,0	M8 (5m)	7,5	17	84,259	4121	IRCM 123 / 132 M 4b		
	2,2	M8 (5m)	9,2	19	73,179	4390	IRCM 123 / 132 M 4c		
	2,6	M8 (5m)	9,2	22	64,396	3863	IRCM 123 / 132 M 4c		
	2,9	M8 (5m)	11	25	57,140	4099	IRCM 123 / 160 M 4b		
	3,2	M8 (5m)	11	27	51,045	3662	IRCM 123 / 160 M 4b		
	3,7	M7 (4m)	15	31	45,853	4485	IRCM 123 / 160 L 4a		
	0,8	M8 (5m)	3	7,0	199,476	3903	IRCM 103 / 100 L 4b		
	0,9	M8 (5m)	4	7,9	177,284	4624	IRCM 103 / 112 M 4b		
	1,2	M8 (5m)	4	10	143,552	3745	IRCM 103 / 112 M 4b		
	1,4	M8 (5m)	5,5	12	119,126	4273	IRCM 103 / 132 S 4c		
	1,5	M8 (5m)	5,5	13	109,276	3919	IRCM 103 / 132 S 4c		
	1,8	M8 (5m)	7,5	15	95,896	4690	IRCM 103 / 132 M 4b		
	2,1	M8 (5m)	7,5	18	78,692	3849	IRCM 103 / 132 M 4b		
	2,2	M8 (5m)	9,2	19	71,869	4312	IRCM 103 / 132 M 4c		
	2,8	M8 (5m)	11	24	58,778	4216	IRCM 103 / 160 M 4b		
	3,2	M8 (5m)	11	27	51,907	3724	IRCM 103 / 160 M 4b		
	1,0	M6 (3m)	4	8,6	162,826	4247	IRCM 93 / 112 M 4b		
	1,1	M6 (3m)	4	9,5	146,946	3833	IRCM 93 / 112 M 4b		
	1,2	M6 (3m)	5,5	10	133,419	4785	IRCM 93 / 132 S 4c		
	1,5	M6 (3m)	5,5	13	111,602	4003	IRCM 93 / 132 S 4c		
	1,9	M6 (3m)	7,5	16	87,936	4301	IRCM 93 / 132 M 4b		
2,1	M5 (2m)	7,5	18	79,841	3905	IRCM 93 / 132 M 4b			
2,5	M5 (2m)	9,2	21	66,785	4007	IRCM 93 / 132 M 4c			
2,7	M5 (2m)	11	23	61,444	4408	IRCM 93 / 160 M 4b			
3,1	M5 (2m)	11	26	54,545	3913	IRCM 93 / 160 M 4b			
3,7	M4 (1Am)	15	31	44,753	4378	IRCM 93 / 160 L 4a			
4,5	M4 (1Am)	18,5	38	37,199	4488	IRCM 93 / 180 M 4b			
4,8	M4 (1Am)	18,5	41	34,034	4106	IRCM 93 / 180 M 4b			



Vinç sistemleri kaldırma redüktörleri güç ve devir tabloları / Power and ratio table for hoisting applications / Tableau de classification des couples et rapports de réduction pour les applications de levage



D _T Tambur Çapı Drum Diameter Diamètre de l'arbre [mm]	V _h Kaldırma Hızı Lifting Speeds Vitesse de levage [m/min]	Vinç Sınıfı Crane Class Classification de l'application de levage ISO (FEM)	P ₁ Motor Gücü Power Puissance [kW]	n ₂ Çıkış Devri Output Speeds Vitesse de sortie [r.p.m]	i Tahvil Ratio Rapport de réduction	M ₂ Çıkış Momenti Output Torque Couple de sortie	Tip Type Typ		 kg
Ø310	1,0	M6 (3m)	4	8,6	162,826	4247	IRCM 93 / 112 M 4b		
	1,2	M6 (3m)	4	9,5	146,946	3833	IRCM 93 / 112 M 4b		
	1,2	M6 (3m)	5,5	10	133,419	4785	IRCM 93 / 132 S 4c		
	1,6	M6 (3m)	5,5	13	111,602	4003	IRCM 93 / 132 S 4c		
	1,9	M5 (2m)	7,5	16	87,936	4301	IRCM 93 / 132 M 4b		
	2,2	M5 (2m)	9,2	18	79,841	4790	IRCM 93 / 132 M 4c		
	2,6	M5 (2m)	9,2	21	66,785	4007	IRCM 93 / 132 M 4c		
	2,8	M5 (2m)	11	23	61,444	4408	IRCM 93 / 160 M 4b		
	3,2	M4 (1Am)	11	26	54,545	3913	IRCM 93 / 160 M 4b		
	3,8	M4 (1Am)	15	31	44,753	4378	IRCM 93 / 160 L 4a		
	4,6	M4 (1Am)	18,5	38	37,199	4488	IRCM 93 / 180 M 4b		
	5,0	M4 (1Am)	18,5	41	34,034	4106	IRCM 93 / 180 M 4b		
Ø320	0,9	M8 (5m)	4	7,1	198,333	5174	IRCM 123 / 112 M 4b		
	1,1	M7 (4m)	4	8,7	161,000	4200	IRCM 123 / 112 M 4b		
	1,3	M7 (4m)	5,5	10	134,473	4823	IRCM 123 / 132 S 4c		
	1,5	M7 (4m)	5,5	12	118,333	4244	IRCM 123 / 132 S 4c		
	1,6	M7 (4m)	7,5	13	105,000	5136	IRCM 123 / 132 M 4b		
	1,9	M7 (4m)	7,5	15	93,800	4588	IRCM 123 / 132 M 4b		
	2,1	M7 (4m)	7,5	17	84,259	4121	IRCM 123 / 132 M 4b		
	2,4	M7 (4m)	9,2	19	73,179	4390	IRCM 123 / 132 M 4c		
	2,8	M7 (4m)	11	22	64,396	4619	IRCM 123 / 160 M 4b		
	3,1	M7 (4m)	11	25	57,140	4099	IRCM 123 / 160 M 4b		
	3,4	M7 (4m)	15	27	51,045	4993	IRCM 123 / 160 L 4a		
	3,9	M7 (4m)	15	31	45,853	4485	IRCM 123 / 160 L 4a		
	0,9	M8 (5m)	4	7,0	199,476	5203	IRCM 103 / 112 M 4b		
	1,0	M8 (5m)	4	7,9	177,284	4624	IRCM 103 / 112 M 4b		
	1,2	M8 (5m)	5,5	10	143,552	5149	IRCM 103 / 132 S 4c		
	1,5	M8 (5m)	5,5	12	119,126	4273	IRCM 103 / 132 S 4c		
	1,6	M8 (5m)	7,5	13	109,276	5345	IRCM 103 / 132 M 4b		
	1,9	M8 (5m)	7,5	15	95,896	4690	IRCM 103 / 132 M 4b		
	2,3	M8 (5m)	9,2	18	78,692	4721	IRCM 103 / 132 M 4c		
	2,4	M8 (5m)	9,2	19	71,869	4312	IRCM 103 / 132 M 4c		
3,0	M8 (5m)	11	24	58,778	4216	IRCM 103 / 160 M 4b			
3,4	M8 (5m)	15	27	51,907	5078	IRCM 103 / 160 L 4a			
Ø330	1,1	M6 (3m)	4	8,6	162,826	4247	IRCM 93 / 112 M 4b		
	1,2	M6 (3m)	5,5	9,5	146,946	5271	IRCM 93 / 132 S 4c		
	1,3	M6 (3m)	5,5	10	133,419	4785	IRCM 93 / 132 S 4c		
	1,6	M5 (2m)	7,5	13	111,602	5458	IRCM 93 / 132 M 4b		
	2,0	M5 (2m)	7,5	16	87,936	4301	IRCM 93 / 132 M 4b		
	2,3	M5 (2m)	9,2	18	79,841	4790	IRCM 93 / 132 M 4c		
	2,6	M4 (1Am)	9,2	21	66,785	4007	IRCM 93 / 132 M 4c		
	2,9	M4 (1Am)	11	23	61,444	4408	IRCM 93 / 160 M 4b		
	3,3	M4 (1Am)	15	26	54,545	5336	IRCM 93 / 160 L 4a		
	3,9	M4 (1Am)	15	31	44,753	4378	IRCM 93 / 160 L 4a		
	1,1	M6 (3m)	4	8,6	162,826	4247	IRCM 93 / 112 M 4b		
	1,2	M6 (3m)	5,5	9,5	146,946	5271	IRCM 93 / 132 S 4c		
1,3	M5 (2m)	5,5	10	133,419	4785	IRCM 93 / 132 S 4c			
1,7	M5 (2m)	7,5	13	111,602	5458	IRCM 93 / 132 M 4b			
2,1	M5 (2m)	7,5	16	87,936	4301	IRCM 93 / 132 M 4b			
2,3	M5 (2m)	9,2	18	79,841	4790	IRCM 93 / 132 M 4c			
2,7	M4 (1Am)	11	21	66,785	4791	IRCM 93 / 160 M 4b			
3,0	M4 (1Am)	11	23	61,444	4408	IRCM 93 / 160 M 4b			
3,4	M4 (1Am)	15	26	54,545	5336	IRCM 93 / 160 L 4a			
4,0	M4 (1Am)	15	31	44,753	4378	IRCM 93 / 160 L 4a			





D _T Tambur Çapı Drum Diameter <i>Diamètre de l'arbre</i> [mm]	V _h Kaldırma Hızı Lifting Speeds <i>Vitesse de levage</i> [m/min]	Vinç Sınıfı Crane Class <i>Classification de l'application de levage</i> ISO (FEM)	P ₁ Motor Gücü Power <i>Puissance</i> [kW]	n ₂ Çıkış Devri Output Speeds <i>Vitesse de sortie</i> [r.p.m]	i Tahvil Ratio <i>Rapport de réduction</i>	M ₂ Çıkış Momenti Output Torque <i>Couple de sortie</i>	Tip Type <i>Typ</i>		 kg
Ø330	0,9	M8 (5m)	4	7,0	199,476	5203	IRCM 103 / 112 M 4b		
	1,0	M8 (5m)	4	7,9	177,284	4624	IRCM 103 / 112 M 4b		
	1,3	M8 (5m)	5,5	10	143,552	5149	IRCM 103 / 132 S 4c		
	1,6	M8 (5m)	5,5	12	119,126	4273	IRCM 103 / 132 S 4c		
	1,7	M8 (5m)	7,5	13	109,276	5345	IRCM 103 / 132 M 4b		
	1,9	M8 (5m)	7,5	15	95,896	4690	IRCM 103 / 132 M 4b		
	2,3	M8 (5m)	9,2	18	78,692	4721	IRCM 103 / 132 M 4c		
	2,5	M8 (5m)	9,2	19	71,869	4312	IRCM 103 / 132 M 4c		
	3,1	M8 (5m)	11	24	58,778	4216	IRCM 103 / 160 M 4b		
Ø340	3,5	M8 (5m)	15	27	51,907	5078	IRCM 103 / 160 L 4a		
	0,9	M7 (4m)	4	7,1	198,333	5174	IRCM 123 / 112 M 4b		
	1,2	M7 (4m)	4	8,7	161,000	4200	IRCM 123 / 112 M 4b		
	1,3	M7 (4m)	5,5	10	134,473	4823	IRCM 123 / 132 S 4c		
	1,6	M7 (4m)	7,5	12	118,333	5788	IRCM 123 / 132 M 4b		
	1,7	M7 (4m)	7,5	13	105,000	5136	IRCM 123 / 132 M 4b		
	2,0	M7 (4m)	7,5	15	93,800	4588	IRCM 123 / 132 M 4b		
	2,3	M7 (4m)	9,2	17	84,259	5055	IRCM 123 / 132 M 4c		
	2,5	M7 (4m)	9,2	19	73,179	4390	IRCM 123 / 132 M 4c		
	2,9	M7 (4m)	11	22	64,396	4619	IRCM 123 / 160 M 4b		
	3,3	M7 (4m)	15	25	57,140	5589	IRCM 123 / 160 L 4a		
	3,6	M7 (4m)	15	27	51,045	4993	IRCM 123 / 160 L 4a		
	4,1	M7 (4m)	15	31	45,853	4485	IRCM 123 / 160 L 4a		
	0,9	M8 (5m)	4	7,0	199,476	5203	IRCM 103 / 112 M 4b		
	1,1	M8 (5m)	4	7,9	177,284	4624	IRCM 103 / 112 M 4b		
1,3	M8 (5m)	5,5	10	143,552	5149	IRCM 103 / 132 S 4c			
1,6	M8 (5m)	7,5	12	119,126	5826	IRCM 103 / 132 M 4b			
1,7	M8 (5m)	7,5	13	109,276	5345	IRCM 103 / 132 M 4b			
2,0	M8 (5m)	7,5	15	95,896	4690	IRCM 103 / 132 M 4b			
2,4	M8 (5m)	9,2	18	78,692	4721	IRCM 103 / 132 M 4c			
2,5	M8 (5m)	9,2	19	71,869	4312	IRCM 103 / 132 M 4c			
3,2	M8 (5m)	15	24	58,778	5750	IRCM 103 / 160 L 4a			
3,6	M8 (5m)	15	27	51,907	5078	IRCM 103 / 160 L 4a			
Ø360	1,0	M7 (4m)	4	7,1	198,333	5174	IRCM 123 / 112 M 4b		
	1,2	M7 (4m)	5,5	8,7	161,000	5775	IRCM 123 / 132 S 4c		
	1,4	M7 (4m)	5,5	10	134,473	4823	IRCM 123 / 132 S 4c		
	1,7	M7 (4m)	7,5	12	118,333	5788	IRCM 123 / 132 M 4b		
	1,8	M7 (4m)	7,5	13	105,000	5136	IRCM 123 / 132 M 4b		
	2,1	M7 (4m)	7,5	15	93,800	4588	IRCM 123 / 132 M 4b		
	2,4	M7 (4m)	9,2	17	84,259	5055	IRCM 123 / 132 M 4c		
	2,7	M7 (4m)	11	19	73,179	5249	IRCM 123 / 160 M 4b		
	3,1	M7 (4m)	11	22	64,396	4619	IRCM 123 / 160 M 4b		
	3,5	M7 (4m)	15	25	57,140	5589	IRCM 123 / 160 L 4a		
	3,8	M7 (4m)	15	27	51,045	4993	IRCM 123 / 160 L 4a		
4,4	M7 (4m)	18,5	31	45,853	5532	IRCM 123 / 180 M 4b			
Ø380	1,1	M7 (4m)	4	7,1	198,333	5174	IRCM 123 / 112 M 4b		
	1,3	M7 (4m)	5,5	8,7	161,000	5775	IRCM 123 / 132 S 4c		
	1,5	M7 (4m)	5,5	10	134,473	4823	IRCM 123 / 132 S 4c		
	1,8	M7 (4m)	7,5	12	118,333	5788	IRCM 123 / 132 M 4b		
	1,9	M7 (4m)	7,5	13	105,000	5136	IRCM 123 / 132 M 4b		
	2,2	M7 (4m)	9,2	15	93,800	5628	IRCM 123 / 132 M 4c		
	2,5	M7 (4m)	9,2	17	84,259	5055	IRCM 123 / 132 M 4c		
	2,8	M7 (4m)	11	19	73,179	5249	IRCM 123 / 160 M 4b		
	3,3	M7 (4m)	15	22	64,396	6299	IRCM 123 / 160 L 4a		
	3,7	M7 (4m)	15	25	57,140	5589	IRCM 123 / 160 L 4a		
	4,0	M7 (4m)	15	27	51,045	4993	IRCM 123 / 160 L 4a		
4,6	M6 (3m)	18,5	31	45,853	5532	IRCM 123 / 180 M 4b			



Vinç sistemleri kaldırma redüktörleri güç ve devir tabloları / Power and ratio table for hoisting applications / Tableau de classification des couples et rapports de réduction pour les applications de levage



D _T Tambur Çapı Drum Diameter <i>Diamètre de l'arbre</i> [mm]	V _h Kaldırma Hızı Lifting Speeds <i>Vitesse de levage</i> [m/min]	Vinç Sınıfı Crane Class <i>Classification de l'application de levage</i> ISO (FEM)	P ₁ Motor Gücü Power <i>Puissance</i> [kW]	n ₂ Çıkış Devri Output Speeds <i>Vitesse de sortie</i> [r.p.m]	i Tahvil Ratio <i>Rapport de réduction</i>	M ₂ Çıkış Momenti Output Torque <i>Couple de sortie</i>	Tip Type <i>Typ</i>		 kg
Ø400	1,1	M7 (4m)	4	7,1	198,333	5174	IRCM 123 / 112 M 4b		
	1,4	M7 (4m)	5,5	8,7	161,000	5775	IRCM 123 / 132 S 4c		
	1,6	M6 (3m)	5,5	10	134,473	4823	IRCM 123 / 132 S 4c		
	1,9	M6 (3m)	7,5	12	118,333	5788	IRCM 123 / 132 M 4b		
	2,0	M6 (3m)	7,5	13	105,000	5136	IRCM 123 / 132 M 4b		
	2,4	M6 (3m)	9,2	15	93,800	5628	IRCM 123 / 132 M 4c		
	2,7	M6 (3m)	9,2	17	84,259	5055	IRCM 123 / 132 M 4c		
	3,0	M6 (3m)	11	19	73,179	5249	IRCM 123 / 160 M 4b		
	3,5	M6 (3m)	15	22	64,396	6299	IRCM 123 / 160 L 4a		
	3,9	M6 (3m)	15	25	57,140	5589	IRCM 123 / 160 L 4a		
	4,2	M6 (3m)	15	27	51,045	4993	IRCM 123 / 160 L 4a		
4,9	M6 (3m)	18,5	31	45,853	5532	IRCM 123 / 180 M 4b			
Ø420	1,2	M6 (3m)	5,5	7,1	198,333	7114	IRCM 123 / 132 S 4c		
	1,4	M6 (3m)	5,5	8,7	161,000	5775	IRCM 123 / 132 S 4c		
	1,6	M6 (3m)	7,5	10	134,473	6577	IRCM 123 / 132 M 4b		
	2,0	M6 (3m)	7,5	12	118,333	5788	IRCM 123 / 132 M 4b		
	2,1	M6 (3m)	7,5	13	105,000	5136	IRCM 123 / 132 M 4b		
	2,5	M6 (3m)	9,2	15	93,800	5628	IRCM 123 / 132 M 4c		
	2,8	M6 (3m)	11	17	84,259	6044	IRCM 123 / 160 M 4b		
	3,1	M6 (3m)	11	19	73,179	5249	IRCM 123 / 160 M 4b		
	3,6	M6 (3m)	15	22	64,396	6299	IRCM 123 / 160 L 4a		
	4,1	M6 (3m)	15	25	57,140	5589	IRCM 123 / 160 L 4a		
	4,5	M6 (3m)	18,5	27	51,045	6158	IRCM 123 / 180 M 4b		
5,1	M6 (3m)	18,5	31	45,853	5532	IRCM 123 / 180 M 4b			
Ø440	1,2	M6 (3m)	5,5	7,1	198,333	7114	IRCM 123 / 132 S 4c		
	1,5	M6 (3m)	5,5	8,7	161,000	5775	IRCM 123 / 132 S 4c		
	1,7	M6 (3m)	7,5	10	134,473	6577	IRCM 123 / 132 M 4b		
	2,1	M6 (3m)	7,5	12	118,333	5788	IRCM 123 / 132 M 4b		
	2,2	M6 (3m)	9,2	13	105,000	6300	IRCM 123 / 132 M 4c		
	2,6	M6 (3m)	9,2	15	93,800	5628	IRCM 123 / 132 M 4c		
	2,9	M6 (3m)	11	17	84,259	6044	IRCM 123 / 160 M 4b		
	3,3	M6 (3m)	15	19	73,179	7158	IRCM 123 / 160 L 4a		
	3,8	M6 (3m)	15	22	64,396	6299	IRCM 123 / 160 L 4a		
	4,3	M6 (3m)	15	25	57,140	5589	IRCM 123 / 160 L 4a		
	4,7	M6 (3m)	18,5	27	51,045	6158	IRCM 123 / 180 M 4b		
5,4	M6 (3m)	18,5	31	45,853	5532	IRCM 123 / 180 M 4b			





D _T Tambur Çapı Drum Diameter <i>Diamètre de l'arbre</i> [mm]	V _h Kaldırma Hızı Lifting Speeds <i>Vitesse de levage</i> [m/min]	Vinç Sınıfı Crane Class <i>Classification de l'application de levage</i> ISO (FEM)	P ₁ Motor Gücü Power <i>Puissance</i> [kW]	n ₂ Çıkış Devri Output Speeds <i>Vitesse de sortie</i> [r.p.m]	i Tahvil Ratio <i>Rapport de réduction</i>	M ₂ Çıkış Momenti Output Torque <i>Couple de sortie</i>	Tip Type <i>Typ</i>		 kg
Ø320	1,8	M6 (3m)	9,2	7,1	198,333	11899	IRCM 123 / 132 M 4c		
	2,2	M6 (3m)	11	8,7	161,000	11549	IRCM 123 / 160 M 4b		
	2,5	M6 (3m)	11	10	134,473	9646	IRCM 123 / 160 M 4b		
	3,0	M6 (3m)	15	12	118,333	11575	IRCM 123 / 160 L 4a		
	3,3	M6 (3m)	15	13	105,000	10271	IRCM 123 / 160 L 4a		
	3,8	M6 (3m)	18,5	15	93,800	11316	IRCM 123 / 180 M 4b		
	4,3	M6 (3m)	18,5	17	84,259	10165	IRCM 123 / 180 M 4b		
	4,8	M6 (3m)	22	19	73,179	10499	IRCM 123 / 180 L 4b		
	5,5	M6 (3m)	30	22	64,396	12598	IRCM 123 / 200 L 4c		
	6,3	M6 (3m)	30	25	57,140	11179	IRCM 123 / 200 L 4c		
	6,8	M6 (3m)	30	27	51,045	9986	IRCM 123 / 200 L 4c		
	7,8	M6 (3m)	37	31	45,853	11064	IRCM 123 / 225 S 4a		
	1,8	M4 (1Am)	9,2	7,0	199,476	11968	IRCM 103 / 132 M 4c		
	2,0	M4 (1Am)	9,2	7,9	177,284	10636	IRCM 103 / 132 M 4c		
	2,5	M4 (1Am)	11	10	143,552	10298	IRCM 103 / 160 M 4b		
	3,0	M4 (1Am)	15	12	119,126	11653	IRCM 103 / 160 L 4a		
	3,3	M4 (1Am)	15	13	109,276	10689	IRCM 103 / 160 L 4a		
	3,8	M4 (1Am)	18,5	15	95,896	11569	IRCM 103 / 180 M 4b		
	4,5	M4 (1Am)	22	18	78,692	11290	IRCM 103 / 180 L 4b		
	4,8	M4 (1Am)	22	19	71,869	10311	IRCM 103 / 180 L 4b		
6,0	M4 (1Am)	30	24	58,778	11499	IRCM 103 / 200 L 4c			
6,8	M3 (1Bm)	30	27	51,907	10155	IRCM 103 / 200 L 4c			
Ø340	1,9	M6 (3m)	9,2	7,1	198,333	11899	IRCM 123 / 132 M 4c		
	2,3	M6 (3m)	11	8,7	161,000	11549	IRCM 123 / 160 M 4b		
	2,7	M6 (3m)	15	10	134,473	13154	IRCM 123 / 160 L 4a		
	3,2	M6 (3m)	15	12	118,333	11575	IRCM 123 / 160 L 4a		
	3,5	M6 (3m)	15	13	105,000	10271	IRCM 123 / 160 L 4a		
	4,0	M6 (3m)	18,5	15	93,800	11316	IRCM 123 / 180 M 4b		
	4,5	M6 (3m)	22	17	84,259	12088	IRCM 123 / 180 L 4b		
	5,1	M6 (3m)	22	19	73,179	10499	IRCM 123 / 180 L 4b		
	5,9	M6 (3m)	30	22	64,396	12598	IRCM 123 / 200 L 4c		
	6,7	M6 (3m)	30	25	57,140	11179	IRCM 123 / 200 L 4c		
	7,2	M6 (3m)	37	27	51,045	12317	IRCM 123 / 225 S 4a		
	8,3	M6 (3m)	37	31	45,853	11064	IRCM 123 / 225 S 4a		
	1,9	M4 (1Am)	9,2	7,0	199,476	11968	IRCM 103 / 132 M 4c		
	2,1	M4 (1Am)	9,2	7,9	177,284	10636	IRCM 103 / 132 M 4c		
	2,6	M4 (1Am)	15	10	143,552	14042	IRCM 103 / 160 L 4a		
	3,2	M4 (1Am)	15	12	119,126	11653	IRCM 103 / 160 L 4a		
	3,5	M4 (1Am)	15	13	109,276	10689	IRCM 103 / 160 L 4a		
	4,0	M4 (1Am)	18,5	15	95,896	11569	IRCM 103 / 180 M 4b		
	4,8	M4 (1Am)	22	18	78,692	11290	IRCM 103 / 180 L 4b		
	5,1	M4 (1Am)	22	19	71,869	10311	IRCM 103 / 180 L 4b		
6,4	M3 (1Bm)	30	24	58,778	11499	IRCM 103 / 200 L 4c			
7,2	M3 (1Bm)	37	27	51,907	12525	IRCM 103 / 225 S 4a			
Ø360	2,0	M6 (3m)	9,2	7,1	198,333	11899	IRCM 123 / 132 M 4c		
	2,5	M6 (3m)	11	8,7	161,000	11549	IRCM 123 / 160 M 4b		
	2,8	M6 (3m)	15	10	134,473	13154	IRCM 123 / 160 L 4a		
	3,4	M6 (3m)	15	12	118,333	11575	IRCM 123 / 160 L 4a		
	3,7	M6 (3m)	18,5	13	105,000	12668	IRCM 123 / 180 M 4b		
	4,2	M6 (3m)	18,5	15	93,800	11316	IRCM 123 / 180 M 4b		
	4,8	M6 (3m)	22	17	84,259	12088	IRCM 123 / 180 L 4b		
	5,4	M6 (3m)	30	19	73,179	14317	IRCM 123 / 200 L 4c		
	6,2	M6 (3m)	30	22	64,396	12598	IRCM 123 / 200 L 4c		
	7,1	M6 (3m)	37	25	57,140	13787	IRCM 123 / 225 S 4a		
	7,6	M6 (3m)	37	27	51,045	12317	IRCM 123 / 225 S 4a		
	8,8	M5 (2m)	45	31	45,853	13456	IRCM 123 / 225 M 4c		



Vinç sistemleri kaldırma redüktörleri güç ve devir tabloları / Power and ratio table for hoisting applications / Tableau de classification des couples et rapports de réduction pour les applications de levage

D _T Tambur Çapı Drum Diameter <i>Diamètre de l'arbre</i> [mm]	V _h Kaldırma Hızı Lifting Speeds <i>Vitesse de levage</i> [m/min]	Vinç Sınıfı Crane Class <i>Classification de l'application de levage</i> ISO (FEM)	P ₁ Motor Gücü Power <i>Puissance</i> [kW]	n ₂ Çıkış Devri Output Speeds <i>Vitesse de sortie</i> [r.p.m]	i Tahvil Ratio <i>Rapport de réduction</i>	M ₂ Çıkış Momenti Output Torque <i>Couple de sortie</i>	Tip Type <i>Typ</i>		 kg
Ø380	2,1	M6 (3m)	9,2	7,1	198,333	11899	IRCM 123 / 132 M 4c		
	2,6	M5 (2m)	15	8,7	161,000	15749	IRCM 123 / 160 L 4a		
	3,0	M5 (2m)	15	10	134,473	13154	IRCM 123 / 160 L 4a		
	3,6	M5 (2m)	18,5	12	118,333	14276	IRCM 123 / 180 M 4b		
	3,9	M5 (2m)	18,5	13	105,000	12668	IRCM 123 / 180 M 4b		
	4,5	M5 (2m)	22	15	93,800	13457	IRCM 123 / 180 L 4b		
	5,1	M5 (2m)	22	17	84,259	12088	IRCM 123 / 180 L 4b		
	5,7	M5 (2m)	30	19	73,179	14317	IRCM 123 / 200 L 4c		
	6,6	M5 (2m)	30	22	64,396	12598	IRCM 123 / 200 L 4c		
	7,5	M5 (2m)	37	25	57,140	13787	IRCM 123 / 225 S 4a		
	8,1	M5 (2m)	37	27	51,045	12317	IRCM 123 / 225 S 4a		
9,2	M5 (2m)	45	31	45,853	13456	IRCM 123 / 225 M 4c			
Ø400	2,2	M5 (2m)	11	7,1	198,333	14227	IRCM 123 / 160 M 4b		
	2,7	M5 (2m)	15	8,7	161,000	15749	IRCM 123 / 160 L 4a		
	3,1	M5 (2m)	15	10	134,473	13154	IRCM 123 / 160 L 4a		
	3,8	M5 (2m)	18,5	12	118,333	14276	IRCM 123 / 180 M 4b		
	4,1	M5 (2m)	18,5	13	105,000	12668	IRCM 123 / 180 M 4b		
	4,7	M5 (2m)	22	15	93,800	13457	IRCM 123 / 180 L 4b		
	5,3	M5 (2m)	30	17	84,259	16484	IRCM 123 / 200 L 4c		
	6,0	M5 (2m)	30	19	73,179	14317	IRCM 123 / 200 L 4c		
	6,9	M5 (2m)	30	22	64,396	12598	IRCM 123 / 200 L 4c		
	7,9	M5 (2m)	37	25	57,140	13787	IRCM 123 / 225 S 4a		
	8,5	M5 (2m)	37	27	51,045	12317	IRCM 123 / 225 S 4a		
9,7	M4 (1Am)	45	31	45,853	13456	IRCM 123 / 225 M 4c			
Ø420	2,3	M5 (2m)	11	7,1	198,333	14227	IRCM 123 / 160 M 4b		
	2,9	M5 (2m)	15	8,7	161,000	15749	IRCM 123 / 160 L 4a		
	3,3	M4 (1Am)	15	10	134,473	13154	IRCM 123 / 160 L 4a		
	4,0	M4 (1Am)	18,5	12	118,333	14276	IRCM 123 / 180 M 4b		
	4,3	M4 (1Am)	18,5	13	105,000	12668	IRCM 123 / 180 M 4b		
	4,9	M4 (1Am)	22	15	93,800	13457	IRCM 123 / 180 L 4b		
	5,6	M4 (1Am)	30	17	84,259	16484	IRCM 123 / 200 L 4c		
	6,3	M4 (1Am)	30	19	73,179	14317	IRCM 123 / 200 L 4c		
	7,3	M4 (1Am)	37	22	64,396	15538	IRCM 123 / 225 S 4a		
	8,2	M4 (1Am)	37	25	57,140	13787	IRCM 123 / 225 S 4a		
	8,9	M4 (1Am)	45	27	51,045	14980	IRCM 123 / 225 M 4c		
10	M4 (1Am)	45	31	45,853	13456	IRCM 123 / 225 M 4c			
Ø440	2,5	M4 (1Am)	11	7,1	198,333	14227	IRCM 123 / 160 M 4b		
	3,0	M4 (1Am)	15	8,7	161,000	15749	IRCM 123 / 160 L 4a		
	3,5	M4 (1Am)	15	10	134,473	13154	IRCM 123 / 160 L 4a		
	4,1	M4 (1Am)	18,5	12	118,333	14276	IRCM 123 / 180 M 4b		
	4,5	M4 (1Am)	22	13	105,000	15064	IRCM 123 / 180 L 4b		
	5,2	M4 (1Am)	30	15	93,800	18351	IRCM 123 / 200 L 4c		
	5,9	M4 (1Am)	30	17	84,259	16484	IRCM 123 / 200 L 4c		
	6,6	M4 (1Am)	30	19	73,179	14317	IRCM 123 / 200 L 4c		
	7,6	M4 (1Am)	37	22	64,396	15538	IRCM 123 / 225 S 4a		
	8,6	M4 (1Am)	45	25	57,140	16768	IRCM 123 / 225 M 4c		
	9,3	M4 (1Am)	45	27	51,045	14980	IRCM 123 / 225 M 4c		
11	M4 (1Am)	55	31	45,853	16446	IRCM 123 / 250 M 4c			



D _T Tambur Çapı Drum Diameter <i>Diamètre de l'arbre</i> [mm]	V _h Kaldırma Hızı Lifting Speeds <i>Vitesse de levage</i> [m/min]	Vinç Sınıfı Crane Class <i>Classification de l'application de levage</i> ISO (FEM)	P ₁ Motor Gücü Power <i>Puissance</i> [kW]	n ₂ Çıkış Devri Output Speeds <i>Vitesse de sortie</i> [r.p.m]	i Tahvil Ratio <i>Rapport de réduction</i>	M ₂ Çıkış Momenti Output Torque <i>Couple de sortie</i>	Tip Type <i>Typ</i>		 kg
Ø450	2,5	M4 (1Am)	11	7,1	198,333	14227	IRCM 123 / 160 M 4b		
	3,1	M4 (1Am)	15	8,7	161,000	15749	IRCM 123 / 160 L 4a		
	3,5	M4 (1Am)	18,5	10	134,473	16223	IRCM 123 / 180 M 4b		
	4,2	M4 (1Am)	18,5	12	118,333	14276	IRCM 123 / 180 M 4b		
	4,6	M4 (1Am)	22	13	105,000	15064	IRCM 123 / 180 L 4b		
	5,3	M4 (1Am)	30	15	93,800	18351	IRCM 123 / 200 L 4c		
	6,0	M4 (1Am)	30	17	84,259	16484	IRCM 123 / 200 L 4c		
	6,7	M4 (1Am)	30	19	73,179	14317	IRCM 123 / 200 L 4c		
	7,8	M4 (1Am)	37	22	64,396	15538	IRCM 123 / 225 S 4a		
	8,8	M4 (1Am)	45	25	57,140	16768	IRCM 123 / 225 M 4c		
	9,5	M4 (1Am)	45	27	51,045	14980	IRCM 123 / 225 M 4c		
11	M4 (1Am)	55	31	45,853	16446	IRCM 123 / 250 M 4c			



Vinç sistemleri kaldırma redüktörleri güç ve devir tabloları / Power and ratio table for hoisting applications / Tableau de classification des couples et rapports de réduction pour les applications de levage

D _T Tambur Çapı Drum Diameter <i>Diamètre de l'arbre</i> [mm]	V _h Kaldırma Hızı Lifting Speeds <i>Vitesse de levage</i> [m/min]	Vinç Sınıfı Crane Class <i>Classification de l'application de levage</i> ISO (FEM)	P ₁ Motor Gücü Power <i>Puissance</i> [kW]	n ₂ Çıkış Devri Output Speeds <i>Vitesse de sortie</i> [r.p.m]	i Tahvil Ratio <i>Rapport de réduction</i>	M ₂ Çıkış Momenti Output Torque <i>Couple de sortie</i>	Tip Type <i>Typ</i>		 kg
Ø280	1,0	M8 (5m)	5,5	7,1	198,333	7114	IRCM 123 / 132 S 4c		
	1,3	M8 (5m)	5,5	8,7	161,000	5775	IRCM 123 / 132 S 4c		
	1,5	M8 (5m)	7,5	10	134,473	6577	IRCM 123 / 132 M 4b		
	1,8	M8 (5m)	9,2	12	118,333	7099	IRCM 123 / 132 M 4c		
	1,9	M8 (5m)	9,2	13	105,000	6300	IRCM 123 / 132 M 4c		
	2,2	M8 (5m)	11	15	93,800	6729	IRCM 123 / 160 M 4b		
	2,5	M8 (5m)	11	17	84,259	6044	IRCM 123 / 160 M 4b		
	2,8	M8 (5m)	15	19	73,179	7158	IRCM 123 / 160 L 4a		
	3,2	M8 (5m)	15	22	64,396	6299	IRCM 123 / 160 L 4a		
	3,7	M8 (5m)	18,5	25	57,140	6894	IRCM 123 / 180 M 4b		
	4,0	M8 (5m)	18,5	27	51,045	6158	IRCM 123 / 180 M 4b		
	4,5	M8 (5m)	22	31	45,853	6578	IRCM 123 / 180 L 4b		
	1,0	M7 (4m)	5,5	7,0	199,476	7155	IRCM 103 / 132 S 4c		
	1,2	M7 (4m)	5,5	7,9	177,284	6359	IRCM 103 / 132 S 4c		
	1,4	M7 (4m)	7,5	10	143,552	7021	IRCM 103 / 132 M 4b		
	1,8	M7 (4m)	9,2	12	119,126	7147	IRCM 103 / 132 M 4c		
	1,9	M7 (4m)	9,2	13	109,276	6556	IRCM 103 / 132 M 4c		
	2,2	M7 (4m)	11	15	95,896	6879	IRCM 103 / 160 M 4b		
	2,6	M7 (4m)	15	18	78,692	7698	IRCM 103 / 160 L 4a		
	2,8	M7 (4m)	15	19	71,869	7030	IRCM 103 / 160 L 4a		
3,5	M7 (4m)	18,5	24	58,778	7091	IRCM 103 / 180 M 4b			
4,0	M7 (4m)	18,5	27	51,907	6262	IRCM 103 / 180 M 4b			
Ø290	1,1	M8 (5m)	5,5	7,1	198,333	7114	IRCM 123 / 132 S 4c		
	1,3	M8 (5m)	7,5	8,7	161,000	7874	IRCM 123 / 132 M 4b		
	1,5	M8 (5m)	7,5	10	134,473	6577	IRCM 123 / 132 M 4b		
	1,8	M8 (5m)	9,2	12	118,333	7099	IRCM 123 / 132 M 4c		
	2,0	M8 (5m)	9,2	13	105,000	6300	IRCM 123 / 132 M 4c		
	2,3	M8 (5m)	11	15	93,800	6729	IRCM 123 / 160 M 4b		
	2,6	M8 (5m)	15	17	84,259	8242	IRCM 123 / 160 L 4a		
	2,9	M8 (5m)	15	19	73,179	7158	IRCM 123 / 160 L 4a		
	3,3	M8 (5m)	15	22	64,396	6299	IRCM 123 / 160 L 4a		
	3,8	M8 (5m)	18,5	25	57,140	6894	IRCM 123 / 180 M 4b		
	4,1	M8 (5m)	18,5	27	51,045	6158	IRCM 123 / 180 M 4b		
	4,7	M8 (5m)	22	31	45,853	6578	IRCM 123 / 180 L 4b		
	1,1	M7 (4m)	5,5	7,0	199,476	7155	IRCM 103 / 132 S 4c		
	1,2	M7 (4m)	5,5	7,9	177,284	6359	IRCM 103 / 132 S 4c		
	1,5	M7 (4m)	7,5	10	143,552	7021	IRCM 103 / 132 M 4b		
	1,8	M7 (4m)	9,2	12	119,126	7147	IRCM 103 / 132 M 4c		
	2,0	M7 (4m)	9,2	13	109,276	6556	IRCM 103 / 132 M 4c		
	2,3	M7 (4m)	11	15	95,896	6879	IRCM 103 / 160 M 4b		
	2,7	M7 (4m)	15	18	78,692	7698	IRCM 103 / 160 L 4a		
	2,9	M7 (4m)	15	19	71,869	7030	IRCM 103 / 160 L 4a		
3,6	M7 (4m)	18,5	24	58,778	7091	IRCM 103 / 180 M 4b			
4,1	M7 (4m)	18,5	27	51,907	6262	IRCM 103 / 180 M 4b			
Ø300	1,1	M8 (5m)	5,5	7,1	198,333	7114	IRCM 123 / 132 S 4c		
	1,4	M8 (5m)	7,5	8,7	161,000	7874	IRCM 123 / 132 M 4b		
	1,6	M8 (5m)	7,5	10	134,473	6577	IRCM 123 / 132 M 4b		
	1,9	M8 (5m)	9,2	12	118,333	7099	IRCM 123 / 132 M 4c		
	2,0	M8 (5m)	9,2	13	105,000	6300	IRCM 123 / 132 M 4c		
	2,4	M8 (5m)	11	15	93,800	6729	IRCM 123 / 160 M 4b		
	2,7	M8 (5m)	15	17	84,259	8242	IRCM 123 / 160 L 4a		
	3,0	M8 (5m)	15	19	73,179	7158	IRCM 123 / 160 L 4a		
	3,5	M8 (5m)	15	22	64,396	6299	IRCM 123 / 160 L 4a		
	3,9	M8 (5m)	18,5	25	57,140	6894	IRCM 123 / 180 M 4b		
	4,2	M8 (5m)	18,5	27	51,045	6158	IRCM 123 / 180 M 4b		
	4,9	M8 (5m)	22	31	45,853	6578	IRCM 123 / 180 L 4b		





D _T Tambur Çapı Drum Diameter <i>Diamètre de l'arbre</i> [mm]	V _h Kaldırma Hızı Lifting Speeds <i>Vitesse de levage</i> [m/min]	Vinç Sınıfı Crane Class <i>Classification de l'application de levage</i> ISO (FEM)	P ₁ Motor Gücü Power <i>Puissance</i> [kW]	n ₂ Çıkış Devri Output Speeds <i>Vitesse de sortie</i> [r.p.m]	i Tahvil Ratio <i>Rapport de réduction</i>	M ₂ Çıkış Momenti Output Torque <i>Couple de sortie</i>	Tip Type <i>Typ</i>			kg
	1,1	M7 (4m)	5,5	7,0	199,476	7155	IRCM 103 / 132 S 4c			
	1,2	M7 (4m)	5,5	7,9	177,284	6359	IRCM 103 / 132 S 4c			
	1,5	M7 (4m)	7,5	10	143,552	7021	IRCM 103 / 132 M 4b			
	1,9	M7 (4m)	9,2	12	119,126	7147	IRCM 103 / 132 M 4c			
	2,0	M7 (4m)	9,2	13	109,276	6556	IRCM 103 / 132 M 4c			
	2,4	M7 (4m)	11	15	95,896	6879	IRCM 103 / 160 M 4b			
	2,8	M7 (4m)	15	18	78,692	7698	IRCM 103 / 160 L 4a			
	3,0	M7 (4m)	15	19	71,869	7030	IRCM 103 / 160 L 4a			
	3,8	M7 (4m)	18,5	24	58,778	7091	IRCM 103 / 180 M 4b			
	4,2	M6 (3m)	18,5	27	51,907	6262	IRCM 103 / 180 M 4b			
Ø320	1,2	M8 (5m)	5,5	7,1	198,333	7114	IRCM 123 / 132 S 4c			
	1,5	M8 (5m)	7,5	8,7	161,000	7874	IRCM 123 / 132 M 4b			
	1,7	M8 (5m)	7,5	10	134,473	6577	IRCM 123 / 132 M 4b			
	2,0	M8 (5m)	9,2	12	118,333	7099	IRCM 123 / 132 M 4c			
	2,2	M8 (5m)	11	13	105,000	7532	IRCM 123 / 160 M 4b			
	2,5	M8 (5m)	11	15	93,800	6729	IRCM 123 / 160 M 4b			
	2,8	M8 (5m)	15	17	84,259	8242	IRCM 123 / 160 L 4a			
	3,2	M8 (5m)	15	19	73,179	7158	IRCM 123 / 160 L 4a			
	3,7	M8 (5m)	18,5	22	64,396	7769	IRCM 123 / 180 M 4b			
	4,2	M8 (5m)	18,5	25	57,140	6894	IRCM 123 / 180 M 4b			
	4,5	M8 (5m)	22	27	51,045	7323	IRCM 123 / 180 L 4b			
	5,2	M8 (5m)	30	31	45,853	8971	IRCM 123 / 200 L 4c			
	1,2	M7 (4m)	5,5	7,0	199,476	7155	IRCM 103 / 132 S 4c			
	1,3	M7 (4m)	7,5	7,9	177,284	8671	IRCM 103 / 132 M 4b			
	1,6	M7 (4m)	7,5	10	143,552	7021	IRCM 103 / 132 M 4b			
	2,0	M7 (4m)	9,2	12	119,126	7147	IRCM 103 / 132 M 4c			
	2,2	M7 (4m)	11	13	109,276	7839	IRCM 103 / 160 M 4b			
	2,5	M7 (4m)	11	15	95,896	6879	IRCM 103 / 160 M 4b			
3,0	M7 (4m)	15	18	78,692	7698	IRCM 103 / 160 L 4a				
3,2	M7 (4m)	15	19	71,869	7030	IRCM 103 / 160 L 4a				
4,0	M7 (4m)	18,5	24	58,778	7091	IRCM 103 / 180 M 4b				
4,5	M6 (3m)	22	27	51,907	7447	IRCM 103 / 180 L 4b				
Ø340	1,3	M8 (5m)	5,5	7,1	198,333	7114	IRCM 123 / 132 S 4c			
	1,5	M8 (5m)	7,5	8,7	161,000	7874	IRCM 123 / 132 M 4b			
	1,8	M8 (5m)	9,2	10	134,473	8068	IRCM 123 / 132 M 4c			
	2,1	M8 (5m)	9,2	12	118,333	7099	IRCM 123 / 132 M 4c			
	2,3	M8 (5m)	11	13	105,000	7532	IRCM 123 / 160 M 4b			
	2,7	M8 (5m)	15	15	93,800	9175	IRCM 123 / 160 L 4a			
	3,0	M8 (5m)	15	17	84,259	8242	IRCM 123 / 160 L 4a			
	3,4	M8 (5m)	15	19	73,179	7158	IRCM 123 / 160 L 4a			
	3,9	M8 (5m)	18,5	22	64,396	7769	IRCM 123 / 180 M 4b			
	4,4	M8 (5m)	22	25	57,140	8198	IRCM 123 / 180 L 4b			
	4,8	M8 (5m)	22	27	51,045	7323	IRCM 123 / 180 L 4b			
	5,5	M7 (4m)	30	31	45,853	8971	IRCM 123 / 200 L 4c			
	1,2	M7 (4m)	5,5	7,0	199,476	7155	IRCM 103 / 132 S 4c			
	1,4	M6 (3m)	7,5	7,9	177,284	8671	IRCM 103 / 132 M 4b			
	1,7	M6 (3m)	7,5	10	143,552	7021	IRCM 103 / 132 M 4b			
	2,1	M6 (3m)	9,2	12	119,126	7147	IRCM 103 / 132 M 4c			
	2,3	M6 (3m)	11	13	109,276	7839	IRCM 103 / 160 M 4b			
	2,7	M6 (3m)	15	15	95,896	9380	IRCM 103 / 160 L 4a			
	3,2	M6 (3m)	15	18	78,692	7698	IRCM 103 / 160 L 4a			
	3,4	M6 (3m)	15	19	71,869	7030	IRCM 103 / 160 L 4a			
4,3	M6 (3m)	18,5	24	58,778	7091	IRCM 103 / 180 M 4b				
4,8	M6 (3m)	22	27	51,907	7447	IRCM 103 / 180 L 4b				



Vinç sistemleri kaldırma redüktörleri güç ve devir tabloları / Power and ratio table for hoisting applications / Tableau de classification des couples et rapports de réduction pour les applications de levage



D _T Tambur Çapı Drum Diameter <i>Diamètre de l'arbre</i> [mm]	V _h Kaldırma Hızı Lifting Speeds <i>Vitesse de levage</i> [m/min]	Vinç Sınıfı Crane Class <i>Classification de l'application de levage</i> ISO (FEM)	P ₁ Motor Gücü Power <i>Puissance</i> [kW]	n ₂ Çıkış Devri Output Speeds <i>Vitesse de sortie</i> [r.p.m]	i Tahvil Ratio <i>Rapport de réduction</i>	M ₂ Çıkış Momenti Output Torque <i>Couple de sortie</i>	Tip Type <i>Typ</i>		 kg
Ø360	1,3	M8 (5m)	7,5	7,1	198,333	9700	IRCM 123 / 132 M 4b		
	1,6	M8 (5m)	7,5	8,7	161,000	7874	IRCM 123 / 132 M 4b		
	1,9	M7 (4m)	9,2	10	134,473	8068	IRCM 123 / 132 M 4c		
	2,3	M7 (4m)	11	12	118,333	8489	IRCM 123 / 160 M 4b		
	2,4	M7 (4m)	11	13	105,000	7532	IRCM 123 / 160 M 4b		
	2,8	M7 (4m)	15	15	93,800	9175	IRCM 123 / 160 L 4a		
	3,2	M7 (4m)	15	17	84,259	8242	IRCM 123 / 160 L 4a		
	3,6	M7 (4m)	18,5	19	73,179	8829	IRCM 123 / 180 M 4b		
	4,1	M7 (4m)	18,5	22	64,396	7769	IRCM 123 / 180 M 4b		
	4,7	M7 (4m)	22	25	57,140	8198	IRCM 123 / 180 L 4b		
	5,1	M7 (4m)	22	27	51,045	7323	IRCM 123 / 180 L 4b		
	5,8	M7 (4m)	30	31	45,853	8971	IRCM 123 / 200 L 4c		
	1,3	M6 (3m)	7,5	7,0	199,476	9756	IRCM 103 / 132 M 4b		
	1,5	M6 (3m)	7,5	7,9	177,284	8671	IRCM 103 / 132 M 4b		
	1,8	M6 (3m)	9,2	10	143,552	8613	IRCM 103 / 132 M 4c		
	2,3	M6 (3m)	11	12	119,126	8545	IRCM 103 / 160 M 4b		
	2,4	M6 (3m)	11	13	109,276	7839	IRCM 103 / 160 M 4b		
	2,8	M6 (3m)	15	15	95,896	9380	IRCM 103 / 160 L 4a		
	3,4	M6 (3m)	15	18	78,692	7698	IRCM 103 / 160 L 4a		
	3,6	M6 (3m)	18,5	19	71,869	8671	IRCM 103 / 180 M 4b		
4,5	M6 (3m)	22	24	58,778	8433	IRCM 103 / 180 L 4b			
5,1	M6 (3m)	22	27	51,907	7447	IRCM 103 / 180 L 4b			
Ø380	1,4	M7 (4m)	7,5	7,1	198,333	9700	IRCM 123 / 132 M 4b		
	1,7	M7 (4m)	7,5	8,7	161,000	7874	IRCM 123 / 132 M 4b		
	2,0	M7 (4m)	9,2	10	134,473	8068	IRCM 123 / 132 M 4c		
	2,4	M7 (4m)	11	12	118,333	8489	IRCM 123 / 160 M 4b		
	2,6	M7 (4m)	15	13	105,000	10271	IRCM 123 / 160 L 4a		
	3,0	M7 (4m)	15	15	93,800	9175	IRCM 123 / 160 L 4a		
	3,4	M7 (4m)	15	17	84,259	8242	IRCM 123 / 160 L 4a		
	3,8	M7 (4m)	18,5	19	73,179	8829	IRCM 123 / 180 M 4b		
	4,4	M7 (4m)	22	22	64,396	9239	IRCM 123 / 180 L 4b		
	5,0	M7 (4m)	22	25	57,140	8198	IRCM 123 / 180 L 4b		
	5,4	M7 (4m)	30	27	51,045	9986	IRCM 123 / 200 L 4c		
	6,2	M7 (4m)	30	31	45,853	8971	IRCM 123 / 200 L 4c		
	1,4	M6 (3m)	7,5	7,0	199,476	9756	IRCM 103 / 132 M 4b		
	1,6	M6 (3m)	7,5	7,9	177,284	8671	IRCM 103 / 132 M 4b		
	1,9	M6 (3m)	9,2	10	143,552	8613	IRCM 103 / 132 M 4c		
	2,4	M6 (3m)	11	12	119,126	8545	IRCM 103 / 160 M 4b		
	2,6	M6 (3m)	15	13	109,276	10689	IRCM 103 / 160 L 4a		
	3,0	M6 (3m)	15	15	95,896	9380	IRCM 103 / 160 L 4a		
	3,6	M6 (3m)	18,5	18	78,692	9494	IRCM 103 / 180 M 4b		
	3,8	M6 (3m)	18,5	19	71,869	8671	IRCM 103 / 180 M 4b		
4,8	M6 (3m)	22	24	58,778	8433	IRCM 103 / 180 L 4b			
5,4	M5 (2m)	30	27	51,907	10155	IRCM 103 / 200 L 4c			
Ø400	1,5	M7 (4m)	7,5	7,1	198,333	9700	IRCM 123 / 132 M 4b		
	1,8	M7 (4m)	9,2	8,7	161,000	9659	IRCM 123 / 132 M 4c		
	2,1	M7 (4m)	9,2	10	134,473	8068	IRCM 123 / 132 M 4c		
	2,5	M7 (4m)	11	12	118,333	8489	IRCM 123 / 160 M 4b		
	2,7	M7 (4m)	15	13	105,000	10271	IRCM 123 / 160 L 4a		
	3,1	M7 (4m)	15	15	93,800	9175	IRCM 123 / 160 L 4a		
	3,6	M7 (4m)	18,5	17	84,259	10165	IRCM 123 / 180 M 4b		
	4,0	M7 (4m)	18,5	19	73,179	8829	IRCM 123 / 180 M 4b		
	4,6	M7 (4m)	22	22	64,396	9239	IRCM 123 / 180 L 4b		
	5,2	M7 (4m)	30	25	57,140	11179	IRCM 123 / 200 L 4c		
	5,7	M7 (4m)	30	27	51,045	9986	IRCM 123 / 200 L 4c		
	6,5	M7 (4m)	30	31	45,853	8971	IRCM 123 / 200 L 4c		





D _T Tambur Çapı Drum Diameter <i>Diamètre de l'arbre</i> [mm]	V _h Kaldırma Hızı Lifting Speeds <i>Vitesse de levage</i> [m/min]	Vinç Sınıfı Crane Class <i>Classification de l'application de levage</i> ISO (FEM)	P ₁ Motor Gücü Power <i>Puissance</i> [kW]	n ₂ Çıkış Devri Output Speeds <i>Vitesse de sortie</i> [r.p.m]	i Tahvil Ratio <i>Rapport de réduction</i>	M ₂ Çıkış Momenti Output Torque <i>Couple de sortie</i>	Tip Type <i>Typ</i>		 kg
Ø420	1,5	M6 (3m)	7,5	7,0	199,476	9756	IRCM 103 / 132 M 4b		
	1,7	M6 (3m)	7,5	7,9	177,284	8671	IRCM 103 / 132 M 4b		
	2,1	M6 (3m)	9,2	10	143,552	8613	IRCM 103 / 132 M 4c		
	2,5	M6 (3m)	11	12	119,126	8545	IRCM 103 / 160 M 4b		
	2,7	M6 (3m)	15	13	109,276	10689	IRCM 103 / 160 L 4a		
	3,1	M6 (3m)	15	15	95,896	9380	IRCM 103 / 160 L 4a		
	3,8	M6 (3m)	18,5	18	78,692	9494	IRCM 103 / 180 M 4b		
	4,0	M6 (3m)	18,5	19	71,869	8671	IRCM 103 / 180 M 4b		
	5,0	M5 (2m)	22	24	58,778	8433	IRCM 103 / 180 L 4b		
	5,7	M5 (2m)	30	27	51,907	10155	IRCM 103 / 200 L 4c		
	1,6	M7 (4m)	7,5	7,1	198,333	9700	IRCM 123 / 132 M 4b		
	1,9	M7 (4m)	9,2	8,7	161,000	9659	IRCM 123 / 132 M 4c		
	2,2	M7 (4m)	11	10	134,473	9646	IRCM 123 / 160 M 4b		
	2,6	M7 (4m)	15	12	118,333	11575	IRCM 123 / 160 L 4a		
	2,9	M7 (4m)	15	13	105,000	10271	IRCM 123 / 160 L 4a		
	3,3	M7 (4m)	15	15	93,800	9175	IRCM 123 / 160 L 4a		
	3,7	M7 (4m)	18,5	17	84,259	10165	IRCM 123 / 180 M 4b		
	4,2	M7 (4m)	18,5	19	73,179	8829	IRCM 123 / 180 M 4b		
4,8	M7 (4m)	22	22	64,396	9239	IRCM 123 / 180 L 4b			
5,5	M7 (4m)	30	25	57,140	11179	IRCM 123 / 200 L 4c			
5,9	M7 (4m)	30	27	51,045	9986	IRCM 123 / 200 L 4c			
6,8	M7 (4m)	30	31	45,853	8971	IRCM 123 / 200 L 4c			
1,5	M5 (2m)	7,5	7,0	199,476	9756	IRCM 103 / 132 M 4b			
1,7	M5 (2m)	7,5	7,9	177,284	8671	IRCM 103 / 132 M 4b			
2,2	M5 (2m)	11	10	143,552	10298	IRCM 103 / 160 M 4b			
2,6	M5 (2m)	15	12	119,126	11653	IRCM 103 / 160 L 4a			
2,9	M5 (2m)	15	13	109,276	10689	IRCM 103 / 160 L 4a			
3,3	M5 (2m)	15	15	95,896	9380	IRCM 103 / 160 L 4a			
4,0	M5 (2m)	18,5	18	78,692	9494	IRCM 103 / 180 M 4b			
4,2	M5 (2m)	18,5	19	71,869	8671	IRCM 103 / 180 M 4b			
5,3	M5 (2m)	30	24	58,778	11499	IRCM 103 / 200 L 4c			
5,9	M4 (1Am)	30	27	51,907	10155	IRCM 103 / 200 L 4c			



Vinc sistemleri kaldırma redüktörleri güç ve devir tabloları / Power and ratio table for hoisting applications / Tableau de classification des couples et rapports de réduction pour les applications de levage

D _T Tambur Çapı Drum Diameter Diamètre de l'arbre [mm]	V _h Kaldırma Hızı Lifting Speeds Vitesse de levage [m/min]	Vinc Sınıfı Crane Class Classification de l'application de levage ISO (FEM)	P ₁ Motor Gücü Power Puissance [kW]	n ₂ Çıkış Devri Output Speeds Vitesse de sortie [r.p.m]	i Tahvil Ratio Rapport de réduction	M ₂ Çıkış Momenti Output Torque Couple de sortie	Tip Type Typ		 kg
Ø270	0,7	M8 (5m)	4	7,0	199,476	5203	IRCM 103 / 112 M 4b		
	0,8	M8 (5m)	4	7,9	177,284	4624	IRCM 103 / 112 M 4b		
	1,0	M8 (5m)	5,5	10	143,552	5149	IRCM 103 / 132 S 4c		
	1,3	M8 (5m)	5,5	12	119,126	4273	IRCM 103 / 132 S 4c		
	1,4	M8 (5m)	7,5	13	109,276	5345	IRCM 103 / 132 M 4b		
	1,6	M8 (5m)	7,5	15	95,896	4690	IRCM 103 / 132 M 4b		
	1,9	M8 (5m)	9,2	18	78,692	4721	IRCM 103 / 132 M 4c		
	2,0	M8 (5m)	9,2	19	71,869	4312	IRCM 103 / 132 M 4c		
	2,5	M8 (5m)	11	24	58,778	4216	IRCM 103 / 160 M 4b		
	2,9	M8 (5m)	15	27	51,907	5078	IRCM 103 / 160 L 4a		
	0,9	M6 (3m)	4	8,6	162,826	4247	IRCM 93 / 112 M 4b		
	1,0	M6 (3m)	5,5	9,5	146,946	5271	IRCM 93 / 132 S 4c		
	1,1	M6 (3m)	5,5	10	133,419	4785	IRCM 93 / 132 S 4c		
	1,4	M5 (2m)	7,5	13	111,602	5458	IRCM 93 / 132 M 4b		
	1,7	M5 (2m)	7,5	16	87,936	4301	IRCM 93 / 132 M 4b		
1,9	M5 (2m)	9,2	18	79,841	4790	IRCM 93 / 132 M 4c			
Ø280	0,8	M8 (5m)	4	7,0	199,476	5203	IRCM 103 / 112 M 4b		
	0,9	M8 (5m)	4	7,9	177,284	4624	IRCM 103 / 112 M 4b		
	1,1	M8 (5m)	5,5	10	143,552	5149	IRCM 103 / 132 S 4c		
	1,3	M8 (5m)	7,5	12	119,126	5826	IRCM 103 / 132 M 4b		
	1,4	M8 (5m)	7,5	13	109,276	5345	IRCM 103 / 132 M 4b		
	1,6	M8 (5m)	7,5	15	95,896	4690	IRCM 103 / 132 M 4b		
	2,0	M8 (5m)	9,2	18	78,692	4721	IRCM 103 / 132 M 4c		
	2,1	M8 (5m)	9,2	19	71,869	4312	IRCM 103 / 132 M 4c		
	2,6	M8 (5m)	15	24	58,778	5750	IRCM 103 / 160 L 4a		
	3,0	M8 (5m)	15	27	51,907	5078	IRCM 103 / 160 L 4a		
Ø290	0,8	M8 (5m)	4	7,0	199,476	5203	IRCM 103 / 112 M 4b		
	0,9	M8 (5m)	4	7,9	177,284	4624	IRCM 103 / 112 M 4b		
	1,1	M8 (5m)	5,5	10	143,552	5149	IRCM 103 / 132 S 4c		
	1,4	M8 (5m)	7,5	12	119,126	5826	IRCM 103 / 132 M 4b		
	1,5	M8 (5m)	7,5	13	109,276	5345	IRCM 103 / 132 M 4b		
	1,7	M8 (5m)	7,5	15	95,896	4690	IRCM 103 / 132 M 4b		
	2,0	M8 (5m)	9,2	18	78,692	4721	IRCM 103 / 132 M 4c		
	2,2	M8 (5m)	11	19	71,869	5155	IRCM 103 / 160 M 4b		
	2,7	M8 (5m)	15	24	58,778	5750	IRCM 103 / 160 L 4a		
Ø300	0,8	M8 (5m)	4	7,0	199,476	5203	IRCM 103 / 112 M 4b		
	0,9	M8 (5m)	4	7,9	177,284	4624	IRCM 103 / 112 M 4b		
	1,2	M8 (5m)	5,5	10	143,552	5149	IRCM 103 / 132 S 4c		
	1,4	M8 (5m)	7,5	12	119,126	5826	IRCM 103 / 132 M 4b		
	1,5	M8 (5m)	7,5	13	109,276	5345	IRCM 103 / 132 M 4b		
	1,8	M8 (5m)	9,2	15	95,896	5753	IRCM 103 / 132 M 4c		
	2,1	M8 (5m)	9,2	18	78,692	4721	IRCM 103 / 132 M 4c		
	2,2	M8 (5m)	11	19	71,869	5155	IRCM 103 / 160 M 4b		
	2,8	M8 (5m)	15	24	58,778	5750	IRCM 103 / 160 L 4a		
	3,2	M8 (5m)	15	27	51,907	5078	IRCM 103 / 160 L 4a		
Ø320	0,9	M8 (5m)	4	7,1	198,333	5174	IRCM 123 / 112 M 4b		
	1,1	M8 (5m)	5,5	8,7	161,000	5775	IRCM 123 / 132 S 4c		
	1,3	M8 (5m)	5,5	10	134,473	4823	IRCM 123 / 132 S 4c		
	1,5	M8 (5m)	7,5	12	118,333	5788	IRCM 123 / 132 M 4b		
	1,6	M8 (5m)	7,5	13	105,000	5136	IRCM 123 / 132 M 4b		
	1,9	M8 (5m)	9,2	15	93,800	5628	IRCM 123 / 132 M 4c		
	2,1	M8 (5m)	9,2	17	84,259	5055	IRCM 123 / 132 M 4c		
	2,4	M8 (5m)	11	19	73,179	5249	IRCM 123 / 160 M 4b		
	2,8	M8 (5m)	15	22	64,396	6299	IRCM 123 / 160 L 4a		
	3,1	M8 (5m)	15	25	57,140	5589	IRCM 123 / 160 L 4a		
	3,4	M8 (5m)	15	27	51,045	4993	IRCM 123 / 160 L 4a		
	3,9	M8 (5m)	18,5	31	45,853	5532	IRCM 123 / 180 M 4b		





D _T Tambur Çapı Drum Diameter <i>Diamètre de l'arbre</i> [mm]	V _h Kaldırma Hızı Lifting Speeds <i>Vitesse de levage</i> [m/min]	Vinç Sınıfı Crane Class <i>Classification de l'application de levage</i> ISO (FEM)	P ₁ Motor Gücü Power <i>Puissance</i> [kW]	n ₂ Çıkış Devri Output Speeds <i>Vitesse de sortie</i> [r.p.m]	i Tahvil Ratio <i>Rapport de réduction</i>	M ₂ Çıkış Momenti Output Torque <i>Couple de sortie</i>	Tip Type <i>Typ</i>		 kg
	0,9	M8 (5m)	4	7,0	199,476	5203	IRCM 103 / 112 M 4b		
	1,0	M8 (5m)	5,5	7,9	177,284	6359	IRCM 103 / 132 S 4c		
	1,2	M8 (5m)	5,5	10	143,552	5149	IRCM 103 / 132 S 4c		
	1,5	M8 (5m)	7,5	12	119,126	5826	IRCM 103 / 132 M 4b		
	1,6	M8 (5m)	7,5	13	109,276	5345	IRCM 103 / 132 M 4b		
	1,9	M8 (5m)	9,2	15	95,896	5753	IRCM 103 / 132 M 4c		
	2,3	M8 (5m)	11	18	78,692	5645	IRCM 103 / 160 M 4b		
	2,4	M8 (5m)	11	19	71,869	5155	IRCM 103 / 160 M 4b		
	3,0	M8 (5m)	15	24	58,778	5750	IRCM 103 / 160 L 4a		
	3,4	M7 (4m)	15	27	51,907	5078	IRCM 103 / 160 L 4a		
Ø340	0,9	M8 (5m)	5,5	7,1	198,333	7114	IRCM 123 / 132 S 4c		
	1,2	M8 (5m)	5,5	8,7	161,000	5775	IRCM 123 / 132 S 4c		
	1,3	M8 (5m)	7,5	10	134,473	6577	IRCM 123 / 132 M 4b		
	1,6	M8 (5m)	7,5	12	118,333	5788	IRCM 123 / 132 M 4b		
	1,7	M8 (5m)	7,5	13	105,000	5136	IRCM 123 / 132 M 4b		
	2,0	M8 (5m)	9,2	15	93,800	5628	IRCM 123 / 132 M 4c		
	2,3	M8 (5m)	11	17	84,259	6044	IRCM 123 / 160 M 4b		
	2,5	M8 (5m)	11	19	73,179	5249	IRCM 123 / 160 M 4b		
	2,9	M8 (5m)	15	22	64,396	6299	IRCM 123 / 160 L 4a		
	3,3	M8 (5m)	15	25	57,140	5589	IRCM 123 / 160 L 4a		
	3,6	M8 (5m)	18,5	27	51,045	6158	IRCM 123 / 180 M 4b		
	4,1	M8 (5m)	18,5	31	45,853	5532	IRCM 123 / 180 M 4b		
	0,9	M8 (5m)	5,5	7,0	199,476	7155	IRCM 103 / 132 S 4c		
	1,1	M8 (5m)	5,5	7,9	177,284	6359	IRCM 103 / 132 S 4c		
	1,3	M8 (5m)	7,5	10	143,552	7021	IRCM 103 / 132 M 4b		
	1,6	M8 (5m)	7,5	12	119,126	5826	IRCM 103 / 132 M 4b		
	1,7	M8 (5m)	7,5	13	109,276	5345	IRCM 103 / 132 M 4b		
	2,0	M8 (5m)	9,2	15	95,896	5753	IRCM 103 / 132 M 4c		
	2,4	M8 (5m)	11	18	78,692	5645	IRCM 103 / 160 M 4b		
	2,5	M8 (5m)	11	19	71,869	5155	IRCM 103 / 160 M 4b		
3,2	M7 (4m)	15	24	58,778	5750	IRCM 103 / 160 L 4a			
3,6	M7 (4m)	18,5	27	51,907	6262	IRCM 103 / 180 M 4b			
Ø360	1,0	M8 (5m)	5,5	7,1	198,333	7114	IRCM 123 / 132 S 4c		
	1,2	M8 (5m)	5,5	8,7	161,000	5775	IRCM 123 / 132 S 4c		
	1,4	M8 (5m)	7,5	10	134,473	6577	IRCM 123 / 132 M 4b		
	1,7	M8 (5m)	7,5	12	118,333	5788	IRCM 123 / 132 M 4b		
	1,8	M8 (5m)	9,2	13	105,000	6300	IRCM 123 / 132 M 4c		
	2,1	M8 (5m)	9,2	15	93,800	5628	IRCM 123 / 132 M 4c		
	2,4	M8 (5m)	11	17	84,259	6044	IRCM 123 / 160 M 4b		
	2,7	M8 (5m)	15	19	73,179	7158	IRCM 123 / 160 L 4a		
	3,1	M8 (5m)	15	22	64,396	6299	IRCM 123 / 160 L 4a		
	3,5	M8 (5m)	18,5	25	57,140	6894	IRCM 123 / 180 M 4b		
	3,8	M8 (5m)	18,5	27	51,045	6158	IRCM 123 / 180 M 4b		
	4,4	M8 (5m)	22	31	45,853	6578	IRCM 123 / 180 L 4b		
	1,0	M7 (4m)	5,5	7,0	199,476	7155	IRCM 103 / 132 S 4c		
	1,1	M7 (4m)	5,5	7,9	177,284	6359	IRCM 103 / 132 S 4c		
	1,4	M7 (4m)	7,5	10	143,552	7021	IRCM 103 / 132 M 4b		
	1,7	M7 (4m)	7,5	12	119,126	5826	IRCM 103 / 132 M 4b		
	1,8	M7 (4m)	9,2	13	109,276	6556	IRCM 103 / 132 M 4c		
	2,1	M7 (4m)	9,2	15	95,896	5753	IRCM 103 / 132 M 4c		
	2,5	M7 (4m)	11	18	78,692	5645	IRCM 103 / 160 M 4b		
	2,7	M7 (4m)	15	19	71,869	7030	IRCM 103 / 160 L 4a		
3,4	M7 (4m)	15	24	58,778	5750	IRCM 103 / 160 L 4a			
3,8	M7 (4m)	18,5	27	51,907	6262	IRCM 103 / 180 M 4b			

Vinç sistemleri kaldırma redüktörleri güç ve devir tabloları / Power and ratio table for hoisting applications / Tableau de classification des couples et rapports de réduction pour les applications de levage





D _T Tambur Çapı Drum Diameter Diamètre de l'arbre [mm]	V _h Kaldırma Hızı Lifting Speeds Vitesse de levage [m/min]	Vinç Sınıfı Crane Class Classification de l'application de levage ISO (FEM)	P ₁ Motor Gücü Power Puissance [kW]	n ₂ Çıkış Devri Output Speeds Vitesse de sortie [r.p.m]	i Tahvil Ratio Rapport de réduction	M ₂ Çıkış Momenti Output Torque Couple de sortie	Tip Type Typ		 kg
Ø380	1,1	M8 (5m)	5,5	7,1	198,333	7114	IRCM 123 / 132 S 4c		
	1,3	M8 (5m)	7,5	8,7	161,000	7874	IRCM 123 / 132 M 4b		
	1,5	M8 (5m)	7,5	10	134,473	6577	IRCM 123 / 132 M 4b		
	1,8	M8 (5m)	9,2	12	118,333	7099	IRCM 123 / 132 M 4c		
	1,9	M8 (5m)	9,2	13	105,000	6300	IRCM 123 / 132 M 4c		
	2,2	M8 (5m)	11	15	93,800	6729	IRCM 123 / 160 M 4b		
	2,5	M8 (5m)	11	17	84,259	6044	IRCM 123 / 160 M 4b		
	2,8	M8 (5m)	15	19	73,179	7158	IRCM 123 / 160 L 4a		
	3,3	M8 (5m)	15	22	64,396	6299	IRCM 123 / 160 L 4a		
	3,7	M8 (5m)	18,5	25	57,140	6894	IRCM 123 / 180 M 4b		
	4,0	M8 (5m)	18,5	27	51,045	6158	IRCM 123 / 180 M 4b		
	4,6	M8 (5m)	22	31	45,853	6578	IRCM 123 / 180 L 4b		
	1,0	M7 (4m)	5,5	7,0	199,476	7155	IRCM 103 / 132 S 4c		
	1,2	M7 (4m)	5,5	7,9	177,284	6359	IRCM 103 / 132 S 4c		
	1,5	M7 (4m)	7,5	10	143,552	7021	IRCM 103 / 132 M 4b		
	1,8	M7 (4m)	9,2	12	119,126	7147	IRCM 103 / 132 M 4c		
	1,9	M7 (4m)	9,2	13	109,276	6556	IRCM 103 / 132 M 4c		
	2,2	M7 (4m)	11	15	95,896	6879	IRCM 103 / 160 M 4b		
	2,7	M7 (4m)	15	18	78,692	7698	IRCM 103 / 160 L 4a		
	2,8	M7 (4m)	15	19	71,869	7030	IRCM 103 / 160 L 4a		
3,6	M7 (4m)	18,5	24	58,778	7091	IRCM 103 / 180 M 4b			
4,0	M7 (4m)	18,5	27	51,907	6262	IRCM 103 / 180 M 4b			



D _T Tambur Çapı Drum Diameter <i>Diamètre de l'arbre</i> [mm]	V _h Kaldırma Hızı Lifting Speeds <i>Vitesse de levage</i> [m/min]	Vinç Sınıfı Crane Class <i>Classification de l'application de levage</i> ISO (FEM)	P ₁ Motor Gücü Power <i>Puissance</i> [kW]	n ₂ Çıkış Devri Output Speeds <i>Vitesse de sortie</i> [r.p.m]	i Tahvil Ratio <i>Rapport de réduction</i>	M ₂ Çıkış Momenti Output Torque <i>Couple de sortie</i>	Tip Type <i>Typ</i>		 kg
Ø280	1,0	M8 (5m)	7,5	7,1	198,333	9700	IRCM 123 / 132 M 4b		
	1,3	M8 (5m)	7,5	8,7	161,000	7874	IRCM 123 / 132 M 4b		
	1,5	M7 (4m)	9,2	10	134,473	8068	IRCM 123 / 132 M 4c		
	1,8	M7 (4m)	11	12	118,333	8489	IRCM 123 / 160 M 4b		
	1,9	M7 (4m)	11	13	105,000	7532	IRCM 123 / 160 M 4b		
	2,2	M7 (4m)	15	15	93,800	9175	IRCM 123 / 160 L 4a		
	2,5	M7 (4m)	15	17	84,259	8242	IRCM 123 / 160 L 4a		
	2,8	M7 (4m)	18,5	19	73,179	8829	IRCM 123 / 180 M 4b		
	3,2	M7 (4m)	18,5	22	64,396	7769	IRCM 123 / 180 M 4b		
	3,7	M7 (4m)	22	25	57,140	8198	IRCM 123 / 180 L 4b		
	4,0	M7 (4m)	22	27	51,045	7323	IRCM 123 / 180 L 4b		
4,5	M7 (4m)	30	31	45,853	8971	IRCM 123 / 200 L 4c			
Ø290	1,1	M8 (5m)	7,5	7,1	198,333	9700	IRCM 123 / 132 M 4b		
	1,3	M7 (4m)	7,5	8,7	161,000	7874	IRCM 123 / 132 M 4b		
	1,5	M7 (4m)	9,2	10	134,473	8068	IRCM 123 / 132 M 4c		
	1,8	M7 (4m)	11	12	118,333	8489	IRCM 123 / 160 M 4b		
	2,0	M7 (4m)	11	13	105,000	7532	IRCM 123 / 160 M 4b		
	2,3	M7 (4m)	15	15	93,800	9175	IRCM 123 / 160 L 4a		
	2,6	M7 (4m)	15	17	84,259	8242	IRCM 123 / 160 L 4a		
	2,9	M7 (4m)	18,5	19	73,179	8829	IRCM 123 / 180 M 4b		
	3,3	M7 (4m)	18,5	22	64,396	7769	IRCM 123 / 180 M 4b		
	3,8	M7 (4m)	22	25	57,140	8198	IRCM 123 / 180 L 4b		
	4,1	M7 (4m)	30	27	51,045	9986	IRCM 123 / 200 L 4c		
4,7	M7 (4m)	30	31	45,853	8971	IRCM 123 / 200 L 4c			
Ø300	1,1	M7 (4m)	7,5	7,1	198,333	9700	IRCM 123 / 132 M 4b		
	1,4	M7 (4m)	9,2	8,7	161,000	9659	IRCM 123 / 132 M 4c		
	1,6	M7 (4m)	9,2	10	134,473	8068	IRCM 123 / 132 M 4c		
	1,9	M7 (4m)	11	12	118,333	8489	IRCM 123 / 160 M 4b		
	2,0	M7 (4m)	15	13	105,000	10271	IRCM 123 / 160 L 4a		
	2,4	M7 (4m)	15	15	93,800	9175	IRCM 123 / 160 L 4a		
	2,7	M7 (4m)	15	17	84,259	8242	IRCM 123 / 160 L 4a		
	3,0	M7 (4m)	18,5	19	73,179	8829	IRCM 123 / 180 M 4b		
	3,5	M7 (4m)	22	22	64,396	9239	IRCM 123 / 180 L 4b		
	3,9	M7 (4m)	22	25	57,140	8198	IRCM 123 / 180 L 4b		
	4,2	M7 (4m)	30	27	51,045	9986	IRCM 123 / 200 L 4c		
4,9	M7 (4m)	30	31	45,853	8971	IRCM 123 / 200 L 4c			
Ø320	1,2	M7 (4m)	7,5	7,1	198,333	9700	IRCM 123 / 132 M 4b		
	1,5	M7 (4m)	9,2	8,7	161,000	9659	IRCM 123 / 132 M 4c		
	1,7	M7 (4m)	11	10	134,473	9646	IRCM 123 / 160 M 4b		
	2,0	M7 (4m)	15	12	118,333	11575	IRCM 123 / 160 L 4a		
	2,2	M7 (4m)	15	13	105,000	10271	IRCM 123 / 160 L 4a		
	2,5	M7 (4m)	15	15	93,800	9175	IRCM 123 / 160 L 4a		
	2,8	M7 (4m)	18,5	17	84,259	10165	IRCM 123 / 180 M 4b		
	3,2	M7 (4m)	18,5	19	73,179	8829	IRCM 123 / 180 M 4b		
	3,7	M7 (4m)	22	22	64,396	9239	IRCM 123 / 180 L 4b		
	4,2	M7 (4m)	30	25	57,140	11179	IRCM 123 / 200 L 4c		
	4,5	M7 (4m)	30	27	51,045	9986	IRCM 123 / 200 L 4c		
5,2	M7 (4m)	30	31	45,853	8971	IRCM 123 / 200 L 4c			



Vinç sistemleri kaldırma redüktörleri güç ve devir tabloları / Power and ratio table for hoisting applications / Tableau de classification des couples et rapports de réduction pour les applications de levage

D _T Tambur Çapı Drum Diameter <i>Diamètre de l'arbre</i> [mm]	V _h Kaldırma Hızı Lifting Speeds <i>Vitesse de levage</i> [m/min]	Vinç Sınıfı Crane Class <i>Classification de l'application de levage</i> ISO (FEM)	P ₁ Motor Gücü Power <i>Puissance</i> [kW]	n ₂ Çıkış Devri Output Speeds <i>Vitesse de sortie</i> [r.p.m]	i Tahvil Ratio <i>Rapport de réduction</i>	M ₂ Çıkış Momenti Output Torque <i>Couple de sortie</i>	Tip Type <i>Typ</i>		 kg
Ø340	1,3	M7 (4m)	7,5	7,1	198,333	9700	IRCM 123 / 132 M 4b		
	1,5	M7 (4m)	9,2	8,7	161,000	9659	IRCM 123 / 132 M 4c		
	1,8	M7 (4m)	11	10	134,473	9646	IRCM 123 / 160 M 4b		
	2,1	M7 (4m)	15	12	118,333	11575	IRCM 123 / 160 L 4a		
	2,3	M7 (4m)	15	13	105,000	10271	IRCM 123 / 160 L 4a		
	2,7	M7 (4m)	15	15	93,800	9175	IRCM 123 / 160 L 4a		
	3,0	M7 (4m)	18,5	17	84,259	10165	IRCM 123 / 180 M 4b		
	3,4	M7 (4m)	22	19	73,179	10499	IRCM 123 / 180 L 4b		
	3,9	M7 (4m)	22	22	64,396	9239	IRCM 123 / 180 L 4b		
	4,4	M7 (4m)	30	25	57,140	11179	IRCM 123 / 200 L 4c		
	4,8	M7 (4m)	30	27	51,045	9986	IRCM 123 / 200 L 4c		
5,5	M6 (3m)	37	31	45,853	11064	IRCM 123 / 225 S 4a			
Ø360	1,3	M7 (4m)	7,5	7,1	198,333	9700	IRCM 123 / 132 M 4b		
	1,6	M6 (3m)	9,2	8,7	161,000	9659	IRCM 123 / 132 M 4c		
	1,9	M6 (3m)	11	10	134,473	9646	IRCM 123 / 160 M 4b		
	2,3	M6 (3m)	15	12	118,333	11575	IRCM 123 / 160 L 4a		
	2,4	M6 (3m)	15	13	105,000	10271	IRCM 123 / 160 L 4a		
	2,8	M6 (3m)	18,5	15	93,800	11316	IRCM 123 / 180 M 4b		
	3,2	M6 (3m)	18,5	17	84,259	10165	IRCM 123 / 180 M 4b		
	3,6	M6 (3m)	22	19	73,179	10499	IRCM 123 / 180 L 4b		
	4,1	M6 (3m)	30	22	64,396	12598	IRCM 123 / 200 L 4c		
	4,7	M6 (3m)	30	25	57,140	11179	IRCM 123 / 200 L 4c		
	5,1	M6 (3m)	30	27	51,045	9986	IRCM 123 / 200 L 4c		
5,8	M6 (3m)	37	31	45,853	11064	IRCM 123 / 225 S 4a			
Ø380	1,4	M6 (3m)	9,2	7,1	198,333	11899	IRCM 123 / 132 M 4c		
	1,7	M6 (3m)	11	8,7	161,000	11549	IRCM 123 / 160 M 4b		
	2,0	M6 (3m)	11	10	134,473	9646	IRCM 123 / 160 M 4b		
	2,4	M6 (3m)	15	12	118,333	11575	IRCM 123 / 160 L 4a		
	2,6	M6 (3m)	15	13	105,000	10271	IRCM 123 / 160 L 4a		
	3,0	M6 (3m)	18,5	15	93,800	11316	IRCM 123 / 180 M 4b		
	3,4	M6 (3m)	22	17	84,259	12088	IRCM 123 / 180 L 4b		
	3,8	M6 (3m)	22	19	73,179	10499	IRCM 123 / 180 L 4b		
	4,4	M6 (3m)	30	22	64,396	12598	IRCM 123 / 200 L 4c		
	5,0	M6 (3m)	30	25	57,140	11179	IRCM 123 / 200 L 4c		
	5,4	M6 (3m)	30	27	51,045	9986	IRCM 123 / 200 L 4c		
6,2	M6 (3m)	37	31	45,853	11064	IRCM 123 / 225 S 4a			
Ø400	1,5	M6 (3m)	9,2	7,1	198,333	11899	IRCM 123 / 132 M 4c		
	1,8	M6 (3m)	11	8,7	161,000	11549	IRCM 123 / 160 M 4b		
	2,1	M6 (3m)	15	10	134,473	13154	IRCM 123 / 160 L 4a		
	2,5	M6 (3m)	15	12	118,333	11575	IRCM 123 / 160 L 4a		
	2,7	M6 (3m)	15	13	105,000	10271	IRCM 123 / 160 L 4a		
	3,1	M6 (3m)	18,5	15	93,800	11316	IRCM 123 / 180 M 4b		
	3,6	M6 (3m)	22	17	84,259	12088	IRCM 123 / 180 L 4b		
	4,0	M6 (3m)	22	19	73,179	10499	IRCM 123 / 180 L 4b		
	4,6	M6 (3m)	30	22	64,396	12598	IRCM 123 / 200 L 4c		
	5,2	M6 (3m)	30	25	57,140	11179	IRCM 123 / 200 L 4c		
	5,7	M6 (3m)	37	27	51,045	12317	IRCM 123 / 225 S 4a		
6,5	M6 (3m)	37	31	45,853	11064	IRCM 123 / 225 S 4a			





D _T Tambur Çapı Drum Diameter <i>Diamètre de l'arbre</i> [mm]	V _h Kaldırma Hızı Lifting Speeds <i>Vitesse de levage</i> [m/min]	Vinç Sınıfı Crane Class <i>Classification de l'application de levage</i> ISO (FEM)	P ₁ Motor Gücü Power <i>Puissance</i> [kW]	n ₂ Çıkış Devri Output Speeds <i>Vitesse de sortie</i> [r.p.m]	i Tahvil Ratio <i>Rapport de réduction</i>	M ₂ Çıkış Momenti Output Torque <i>Couple de sortie</i>	Tip Type <i>Typ</i>		 kg
Ø420	1,6	M6 (3m)	9,2	7,1	198,333	11899	IRCM 123 / 132 M 4c		
	1,9	M6 (3m)	11	8,7	161,000	11549	IRCM 123 / 160 M 4b		
	2,2	M6 (3m)	15	10	134,473	13154	IRCM 123 / 160 L 4a		
	2,6	M6 (3m)	15	12	118,333	11575	IRCM 123 / 160 L 4a		
	2,9	M6 (3m)	18,5	13	105,000	12668	IRCM 123 / 180 M 4b		
	3,3	M6 (3m)	18,5	15	93,800	11316	IRCM 123 / 180 M 4b		
	3,7	M6 (3m)	22	17	84,259	12088	IRCM 123 / 180 L 4b		
	4,2	M6 (3m)	30	19	73,179	14317	IRCM 123 / 200 L 4c		
	4,8	M6 (3m)	30	22	64,396	12598	IRCM 123 / 200 L 4c		
	5,5	M6 (3m)	37	25	57,140	13787	IRCM 123 / 225 S 4a		
	5,9	M6 (3m)	37	27	51,045	12317	IRCM 123 / 225 S 4a		
Ø440	6,8	M5 (2m)	45	31	45,853	13456	IRCM 123 / 225 M 4c		
	1,6	M6 (3m)	9,2	7,1	198,333	11899	IRCM 123 / 132 M 4c		
	2,0	M5 (2m)	15	8,7	161,000	15749	IRCM 123 / 160 L 4a		
	2,3	M5 (2m)	15	10	134,473	13154	IRCM 123 / 160 L 4a		
	2,8	M5 (2m)	18,5	12	118,333	14276	IRCM 123 / 180 M 4b		
	3,0	M5 (2m)	18,5	13	105,000	12668	IRCM 123 / 180 M 4b		
	3,5	M5 (2m)	22	15	93,800	13457	IRCM 123 / 180 L 4b		
	3,9	M5 (2m)	22	17	84,259	12088	IRCM 123 / 180 L 4b		
	4,4	M5 (2m)	30	19	73,179	14317	IRCM 123 / 200 L 4c		
	5,1	M5 (2m)	30	22	64,396	12598	IRCM 123 / 200 L 4c		
	5,8	M5 (2m)	37	25	57,140	13787	IRCM 123 / 225 S 4a		
6,2	M5 (2m)	37	27	51,045	12317	IRCM 123 / 225 S 4a			
7,1	M5 (2m)	45	31	45,853	13456	IRCM 123 / 225 M 4c			



Vinç sistemleri kaldırma redüktörleri güç ve devir tabloları / Power and ratio table for hoisting applications / Tableau de classification des couples et rapports de réduction pour les applications de levage

D _T Tambur Çapı Drum Diameter <i>Diamètre de l'arbre</i> [mm]	V _h Kaldırma Hızı Lifting Speeds <i>Vitesse de levage</i> [m/min]	Vinç Sınıfı Crane Class <i>Classification de l'application de levage</i> ISO (FEM)	P ₁ Motor Gücü Power <i>Puissance</i> [kW]	n ₂ Çıkış Devri Output Speeds <i>Vitesse de sortie</i> [r.p.m]	i Tahvil Ratio <i>Rapport de réduction</i>	M ₂ Çıkış Momenti Output Torque <i>Couple de sortie</i>	Tip Type <i>Typ</i>		 kg
Ø280	0,8	M8 (5m)	5,5	7,1	198,333	7114	IRCM 123 / 132 S 4c		
	1,0	M8 (5m)	5,5	8,7	161,000	5775	IRCM 123 / 132 S 4c		
	1,1	M8 (5m)	7,5	10	134,473	6577	IRCM 123 / 132 M 4b		
	1,3	M8 (5m)	7,5	12	118,333	5788	IRCM 123 / 132 M 4b		
	1,4	M8 (5m)	9,2	13	105,000	6300	IRCM 123 / 132 M 4c		
	1,6	M8 (5m)	9,2	15	93,800	5628	IRCM 123 / 132 M 4c		
	1,9	M8 (5m)	11	17	84,259	6044	IRCM 123 / 160 M 4b		
	2,1	M8 (5m)	15	19	73,179	7158	IRCM 123 / 160 L 4a		
	2,4	M8 (5m)	15	22	64,396	6299	IRCM 123 / 160 L 4a		
	2,7	M8 (5m)	18,5	25	57,140	6894	IRCM 123 / 180 M 4b		
	3,0	M8 (5m)	18,5	27	51,045	6158	IRCM 123 / 180 M 4b		
	3,4	M8 (5m)	22	31	45,853	6578	IRCM 123 / 180 L 4b		
	0,8	M7 (4m)	5,5	7,0	199,476	7155	IRCM 103 / 132 S 4c		
	0,9	M7 (4m)	5,5	7,9	177,284	6359	IRCM 103 / 132 S 4c		
	1,1	M7 (4m)	7,5	10	143,552	7021	IRCM 103 / 132 M 4b		
	1,3	M7 (4m)	7,5	12	119,126	5826	IRCM 103 / 132 M 4b		
	1,4	M7 (4m)	9,2	13	109,276	6556	IRCM 103 / 132 M 4c		
	1,6	M7 (4m)	9,2	15	95,896	5753	IRCM 103 / 132 M 4c		
	2,0	M7 (4m)	11	18	78,692	5645	IRCM 103 / 160 M 4b		
	2,1	M7 (4m)	15	19	71,869	7030	IRCM 103 / 160 L 4a		
2,6	M7 (4m)	15	24	58,778	5750	IRCM 103 / 160 L 4a			
3,0	M7 (4m)	18,5	27	51,907	6262	IRCM 103 / 180 M 4b			
Ø290	0,8	M8 (5m)	5,5	7,1	198,333	7114	IRCM 123 / 132 S 4c		
	1,0	M8 (5m)	5,5	8,7	161,000	5775	IRCM 123 / 132 S 4c		
	1,1	M8 (5m)	7,5	10	134,473	6577	IRCM 123 / 132 M 4b		
	1,4	M8 (5m)	9,2	12	118,333	7099	IRCM 123 / 132 M 4c		
	1,5	M8 (5m)	9,2	13	105,000	6300	IRCM 123 / 132 M 4c		
	1,7	M8 (5m)	11	15	93,800	6729	IRCM 123 / 160 M 4b		
	1,9	M8 (5m)	11	17	84,259	6044	IRCM 123 / 160 M 4b		
	2,2	M8 (5m)	15	19	73,179	7158	IRCM 123 / 160 L 4a		
	2,5	M8 (5m)	15	22	64,396	6299	IRCM 123 / 160 L 4a		
	2,8	M8 (5m)	18,5	25	57,140	6894	IRCM 123 / 180 M 4b		
	3,1	M8 (5m)	18,5	27	51,045	6158	IRCM 123 / 180 M 4b		
	3,5	M8 (5m)	22	31	45,853	6578	IRCM 123 / 180 L 4b		
	0,8	M7 (4m)	5,5	7,0	199,476	7155	IRCM 103 / 132 S 4c		
	0,9	M7 (4m)	5,5	7,9	177,284	6359	IRCM 103 / 132 S 4c		
	1,1	M7 (4m)	7,5	10	143,552	7021	IRCM 103 / 132 M 4b		
	1,4	M7 (4m)	9,2	12	119,126	7147	IRCM 103 / 132 M 4c		
	1,5	M7 (4m)	9,2	13	109,276	6556	IRCM 103 / 132 M 4c		
	1,7	M7 (4m)	11	15	95,896	6879	IRCM 103 / 160 M 4b		
	2,0	M7 (4m)	15	18	78,692	7698	IRCM 103 / 160 L 4a		
	2,2	M7 (4m)	15	19	71,869	7030	IRCM 103 / 160 L 4a		
2,7	M7 (4m)	18,5	24	58,778	7091	IRCM 103 / 180 M 4b			
3,1	M7 (4m)	18,5	27	51,907	6262	IRCM 103 / 180 M 4b			
Ø300	0,8	M8 (5m)	5,5	7,1	198,333	7114	IRCM 123 / 132 S 4c		
	1,0	M8 (5m)	7,5	8,7	161,000	7874	IRCM 123 / 132 M 4b		
	1,2	M8 (5m)	7,5	10	134,473	6577	IRCM 123 / 132 M 4b		
	1,4	M8 (5m)	9,2	12	118,333	7099	IRCM 123 / 132 M 4c		
	1,5	M8 (5m)	9,2	13	105,000	6300	IRCM 123 / 132 M 4c		
	1,8	M8 (5m)	11	15	93,800	6729	IRCM 123 / 160 M 4b		
	2,0	M8 (5m)	15	17	84,259	8242	IRCM 123 / 160 L 4a		
	2,2	M8 (5m)	15	19	73,179	7158	IRCM 123 / 160 L 4a		
	2,6	M8 (5m)	15	22	64,396	6299	IRCM 123 / 160 L 4a		
	2,9	M8 (5m)	18,5	25	57,140	6894	IRCM 123 / 180 M 4b		
	3,2	M8 (5m)	18,5	27	51,045	6158	IRCM 123 / 180 M 4b		
	3,7	M8 (5m)	22	31	45,853	6578	IRCM 123 / 180 L 4b		





D _T Tambur Çapı Drum Diameter <i>Diamètre de l'arbre</i> [mm]	V _h Kaldırma Hızı Lifting Speeds <i>Vitesse de levage</i> [m/min]	Vinç Sınıfı Crane Class <i>Classification de l'application de levage</i> ISO (FEM)	P ₁ Motor Gücü Power <i>Puissance</i> [kW]	n ₂ Çıkış Devri Output Speeds <i>Vitesse de sortie</i> [r.p.m]	i Tahvil Ratio <i>Rapport de réduction</i>	M ₂ Çıkış Momenti Output Torque <i>Couple de sortie</i>	Tip Type <i>Typ</i>		 kg
	0,8	M7 (4m)	5,5	7,0	199,476	7155	IRCM 103 / 132 S 4c		
	0,9	M7 (4m)	5,5	7,9	177,284	6359	IRCM 103 / 132 S 4c		
	1,2	M7 (4m)	7,5	10	143,552	7021	IRCM 103 / 132 M 4b		
	1,4	M7 (4m)	9,2	12	119,126	7147	IRCM 103 / 132 M 4c		
	1,5	M7 (4m)	9,2	13	109,276	6556	IRCM 103 / 132 M 4c		
	1,8	M7 (4m)	11	15	95,896	6879	IRCM 103 / 160 M 4b		
	2,1	M7 (4m)	15	18	78,692	7698	IRCM 103 / 160 L 4a		
	2,2	M7 (4m)	15	19	71,869	7030	IRCM 103 / 160 L 4a		
	2,8	M7 (4m)	18,5	24	58,778	7091	IRCM 103 / 180 M 4b		
	3,2	M7 (4m)	18,5	27	51,907	6262	IRCM 103 / 180 M 4b		
Ø320	0,9	M8 (5m)	5,5	7,1	198,333	7114	IRCM 123 / 132 S 4c		
	1,1	M8 (5m)	7,5	8,7	161,000	7874	IRCM 123 / 132 M 4b		
	1,3	M8 (5m)	7,5	10	134,473	6577	IRCM 123 / 132 M 4b		
	1,5	M8 (5m)	9,2	12	118,333	7099	IRCM 123 / 132 M 4c		
	1,6	M8 (5m)	9,2	13	105,000	6300	IRCM 123 / 132 M 4c		
	1,9	M8 (5m)	11	15	93,800	6729	IRCM 123 / 160 M 4b		
	2,1	M8 (5m)	15	17	84,259	8242	IRCM 123 / 160 L 4a		
	2,4	M8 (5m)	15	19	73,179	7158	IRCM 123 / 160 L 4a		
	2,8	M8 (5m)	18,5	22	64,396	7769	IRCM 123 / 180 M 4b		
	3,1	M8 (5m)	18,5	25	57,140	6894	IRCM 123 / 180 M 4b		
	3,4	M8 (5m)	22	27	51,045	7323	IRCM 123 / 180 L 4b		
	3,9	M8 (5m)	22	31	45,853	6578	IRCM 123 / 180 L 4b		
	0,9	M7 (4m)	5,5	7,0	199,476	7155	IRCM 103 / 132 S 4c		
	1,0	M7 (4m)	5,5	7,9	177,284	6359	IRCM 103 / 132 S 4c		
	1,2	M7 (4m)	7,5	10	143,552	7021	IRCM 103 / 132 M 4b		
	1,5	M7 (4m)	9,2	12	119,126	7147	IRCM 103 / 132 M 4c		
1,6	M7 (4m)	9,2	13	109,276	6556	IRCM 103 / 132 M 4c			
1,9	M7 (4m)	11	15	95,896	6879	IRCM 103 / 160 M 4b			
2,3	M7 (4m)	15	18	78,692	7698	IRCM 103 / 160 L 4a			
2,4	M7 (4m)	15	19	71,869	7030	IRCM 103 / 160 L 4a			
3,0	M7 (4m)	18,5	24	58,778	7091	IRCM 103 / 180 M 4b			
3,4	M6 (3m)	22	27	51,907	7447	IRCM 103 / 180 L 4b			
Ø340	0,9	M8 (5m)	5,5	7,1	198,333	7114	IRCM 123 / 132 S 4c		
	1,2	M8 (5m)	7,5	8,7	161,000	7874	IRCM 123 / 132 M 4b		
	1,3	M8 (5m)	7,5	10	134,473	6577	IRCM 123 / 132 M 4b		
	1,6	M8 (5m)	9,2	12	118,333	7099	IRCM 123 / 132 M 4c		
	1,7	M8 (5m)	11	13	105,000	7532	IRCM 123 / 160 M 4b		
	2,0	M8 (5m)	15	15	93,800	9175	IRCM 123 / 160 L 4a		
	2,3	M8 (5m)	15	17	84,259	8242	IRCM 123 / 160 L 4a		
	2,5	M8 (5m)	15	19	73,179	7158	IRCM 123 / 160 L 4a		
	2,9	M8 (5m)	18,5	22	64,396	7769	IRCM 123 / 180 M 4b		
	3,3	M8 (5m)	18,5	25	57,140	6894	IRCM 123 / 180 M 4b		
	3,6	M8 (5m)	22	27	51,045	7323	IRCM 123 / 180 L 4b		
	4,1	M8 (5m)	30	31	45,853	8971	IRCM 123 / 200 L 4c		
	0,9	M7 (4m)	5,5	7,0	199,476	7155	IRCM 103 / 132 S 4c		
	1,1	M7 (4m)	7,5	7,9	177,284	8671	IRCM 103 / 132 M 4b		
	1,3	M7 (4m)	7,5	10	143,552	7021	IRCM 103 / 132 M 4b		
	1,6	M7 (4m)	9,2	12	119,126	7147	IRCM 103 / 132 M 4c		
	1,7	M7 (4m)	11	13	109,276	7839	IRCM 103 / 160 M 4b		
	2,0	M7 (4m)	15	15	95,896	9380	IRCM 103 / 160 L 4a		
2,4	M7 (4m)	15	18	78,692	7698	IRCM 103 / 160 L 4a			
2,5	M7 (4m)	15	19	71,869	7030	IRCM 103 / 160 L 4a			
3,2	M6 (3m)	18,5	24	58,778	7091	IRCM 103 / 180 M 4b			
3,6	M6 (3m)	22	27	51,907	7447	IRCM 103 / 180 L 4b			



Vinç sistemleri kaldırma redüktörleri güç ve devir tabloları / Power and ratio table for hoisting applications / Tableau de classification des couples et rapports de réduction pour les applications de levage



D _T Tambur Çapı Drum Diameter <i>Diamètre de l'arbre</i> [mm]	V _h Kaldırma Hızı Lifting Speeds <i>Vitesse de levage</i> [m/min]	Vinç Sınıfı Crane Class <i>Classification de l'application de levage</i> ISO (FEM)	P ₁ Motor Gücü Power <i>Puissance</i> [kW]	n ₂ Çıkış Devri Output Speeds <i>Vitesse de sortie</i> [r.p.m]	i Tahvil Ratio <i>Rapport de réduction</i>	M ₂ Çıkış Momenti Output Torque <i>Couple de sortie</i>	Tip Type <i>Typ</i>		 kg
Ø360	1,0	M8 (5m)	7,5	7,1	198,333	9700	IRCM 123 / 132 M 4b		
	1,2	M8 (5m)	7,5	8,7	161,000	7874	IRCM 123 / 132 M 4b		
	1,4	M8 (5m)	9,2	10	134,473	8068	IRCM 123 / 132 M 4c		
	1,7	M8 (5m)	11	12	118,333	8489	IRCM 123 / 160 M 4b		
	1,8	M8 (5m)	11	13	105,000	7532	IRCM 123 / 160 M 4b		
	2,1	M8 (5m)	15	15	93,800	9175	IRCM 123 / 160 L 4a		
	2,4	M8 (5m)	15	17	84,259	8242	IRCM 123 / 160 L 4a		
	2,7	M8 (5m)	15	19	73,179	7158	IRCM 123 / 160 L 4a		
	3,1	M8 (5m)	18,5	22	64,396	7769	IRCM 123 / 180 M 4b		
	3,5	M8 (5m)	22	25	57,140	8198	IRCM 123 / 180 L 4b		
	3,8	M8 (5m)	22	27	51,045	7323	IRCM 123 / 180 L 4b		
	4,4	M7 (4m)	30	31	45,853	8971	IRCM 123 / 200 L 4c		
	1,0	M6 (3m)	5,5	7,0	199,476	7155	IRCM 103 / 132 S 4c		
	1,1	M6 (3m)	7,5	7,9	177,284	8671	IRCM 103 / 132 M 4b		
	1,4	M6 (3m)	9,2	10	143,552	8613	IRCM 103 / 132 M 4c		
	1,7	M6 (3m)	11	12	119,126	8545	IRCM 103 / 160 M 4b		
	1,8	M6 (3m)	11	13	109,276	7839	IRCM 103 / 160 M 4b		
	2,1	M6 (3m)	15	15	95,896	9380	IRCM 103 / 160 L 4a		
	2,5	M6 (3m)	15	18	78,692	7698	IRCM 103 / 160 L 4a		
	2,7	M6 (3m)	15	19	71,869	7030	IRCM 103 / 160 L 4a		
3,4	M6 (3m)	22	24	58,778	8433	IRCM 103 / 180 L 4b			
3,8	M6 (3m)	22	27	51,907	7447	IRCM 103 / 180 L 4b			
Ø380	1,1	M8 (5m)	7,5	7,1	198,333	9700	IRCM 123 / 132 M 4b		
	1,3	M7 (4m)	7,5	8,7	161,000	7874	IRCM 123 / 132 M 4b		
	1,5	M7 (4m)	9,2	10	134,473	8068	IRCM 123 / 132 M 4c		
	1,8	M7 (4m)	11	12	118,333	8489	IRCM 123 / 160 M 4b		
	1,9	M7 (4m)	11	13	105,000	7532	IRCM 123 / 160 M 4b		
	2,2	M7 (4m)	15	15	93,800	9175	IRCM 123 / 160 L 4a		
	2,5	M7 (4m)	15	17	84,259	8242	IRCM 123 / 160 L 4a		
	2,8	M7 (4m)	18,5	19	73,179	8829	IRCM 123 / 180 M 4b		
	3,3	M7 (4m)	18,5	22	64,396	7769	IRCM 123 / 180 M 4b		
	3,7	M7 (4m)	22	25	57,140	8198	IRCM 123 / 180 L 4b		
	4,0	M7 (4m)	30	27	51,045	9986	IRCM 123 / 200 L 4c		
	4,6	M7 (4m)	30	31	45,853	8971	IRCM 123 / 200 L 4c		
	1,0	M6 (3m)	7,5	7,0	199,476	9756	IRCM 103 / 132 M 4b		
	1,2	M6 (3m)	7,5	7,9	177,284	8671	IRCM 103 / 132 M 4b		
	1,5	M6 (3m)	9,2	10	143,552	8613	IRCM 103 / 132 M 4c		
	1,8	M6 (3m)	11	12	119,126	8545	IRCM 103 / 160 M 4b		
	1,9	M6 (3m)	11	13	109,276	7839	IRCM 103 / 160 M 4b		
	2,2	M6 (3m)	15	15	95,896	9380	IRCM 103 / 160 L 4a		
	2,7	M6 (3m)	15	18	78,692	7698	IRCM 103 / 160 L 4a		
	2,8	M6 (3m)	18,5	19	71,869	8671	IRCM 103 / 180 M 4b		
3,6	M6 (3m)	22	24	58,778	8433	IRCM 103 / 180 L 4b			
4,0	M5 (2m)	30	27	51,907	10155	IRCM 103 / 200 L 4c			
Ø400	1,1	M7 (4m)	7,5	7,1	198,333	9700	IRCM 123 / 132 M 4b		
	1,4	M7 (4m)	9,2	8,7	161,000	9659	IRCM 123 / 132 M 4c		
	1,6	M7 (4m)	9,2	10	134,473	8068	IRCM 123 / 132 M 4c		
	1,9	M7 (4m)	11	12	118,333	8489	IRCM 123 / 160 M 4b		
	2,0	M7 (4m)	15	13	105,000	10271	IRCM 123 / 160 L 4a		
	2,4	M7 (4m)	15	15	93,800	9175	IRCM 123 / 160 L 4a		
	2,7	M7 (4m)	15	17	84,259	8242	IRCM 123 / 160 L 4a		
	3,0	M7 (4m)	18,5	19	73,179	8829	IRCM 123 / 180 M 4b		
	3,5	M7 (4m)	22	22	64,396	9239	IRCM 123 / 180 L 4b		
	3,9	M7 (4m)	22	25	57,140	8198	IRCM 123 / 180 L 4b		
	4,2	M7 (4m)	30	27	51,045	9986	IRCM 123 / 200 L 4c		
	4,9	M7 (4m)	30	31	45,853	8971	IRCM 123 / 200 L 4c		





D _T Tambur Çapı Drum Diameter <i>Diamètre de l'arbre</i> [mm]	V _h Kaldırma Hızı Lifting Speeds <i>Vitesse de levage</i> [m/min]	Vinç Sınıfı Crane Class <i>Classification de l'application de levage</i> ISO (FEM)	P ₁ Motor Gücü Power <i>Puissance</i> [kW]	n ₂ Çıkış Devri Output Speeds <i>Vitesse de sortie</i> [r.p.m]	i Tahvil Ratio <i>Rapport de réduction</i>	M ₂ Çıkış Momenti Output Torque <i>Couple de sortie</i>	Tip Type <i>Typ</i>		 kg
	1,1	M6 (3m)	7,5	7,0	199,476	9756	IRCM 103 / 132 M 4b		
	1,2	M6 (3m)	7,5	7,9	177,284	8671	IRCM 103 / 132 M 4b		
	1,5	M6 (3m)	9,2	10	143,552	8613	IRCM 103 / 132 M 4c		
	1,9	M6 (3m)	11	12	119,126	8545	IRCM 103 / 160 M 4b		
	2,0	M6 (3m)	15	13	109,276	10689	IRCM 103 / 160 L 4a		
	2,4	M6 (3m)	15	15	95,896	9380	IRCM 103 / 160 L 4a		
	2,8	M6 (3m)	18,5	18	78,692	9494	IRCM 103 / 180 M 4b		
	3,0	M6 (3m)	18,5	19	71,869	8671	IRCM 103 / 180 M 4b		
	3,8	M6 (3m)	22	24	58,778	8433	IRCM 103 / 180 L 4b		
	4,2	M5 (2m)	30	27	51,907	10155	IRCM 103 / 200 L 4c		
Ø420	1,2	M7 (4m)	7,5	7,1	198,333	9700	IRCM 123 / 132 M 4b		
	1,4	M7 (4m)	9,2	8,7	161,000	9659	IRCM 123 / 132 M 4c		
	1,6	M7 (4m)	9,2	10	134,473	8068	IRCM 123 / 132 M 4c		
	2,0	M7 (4m)	11	12	118,333	8489	IRCM 123 / 160 M 4b		
	2,1	M7 (4m)	15	13	105,000	10271	IRCM 123 / 160 L 4a		
	2,5	M7 (4m)	15	15	93,800	9175	IRCM 123 / 160 L 4a		
	2,8	M7 (4m)	18,5	17	84,259	10165	IRCM 123 / 180 M 4b		
	3,1	M7 (4m)	18,5	19	73,179	8829	IRCM 123 / 180 M 4b		
	3,6	M7 (4m)	22	22	64,396	9239	IRCM 123 / 180 L 4b		
	4,1	M7 (4m)	30	25	57,140	11179	IRCM 123 / 200 L 4c		
	4,5	M7 (4m)	30	27	51,045	9986	IRCM 123 / 200 L 4c		
	5,1	M7 (4m)	30	31	45,853	8971	IRCM 123 / 200 L 4c		
	1,2	M6 (3m)	7,5	7,0	199,476	9756	IRCM 103 / 132 M 4b		
	1,3	M6 (3m)	7,5	7,9	177,284	8671	IRCM 103 / 132 M 4b		
	1,6	M6 (3m)	9,2	10	143,552	8613	IRCM 103 / 132 M 4c		
	2,0	M6 (3m)	11	12	119,126	8545	IRCM 103 / 160 M 4b		
	2,1	M6 (3m)	15	13	109,276	10689	IRCM 103 / 160 L 4a		
	2,5	M6 (3m)	15	15	95,896	9380	IRCM 103 / 160 L 4a		
3,0	M6 (3m)	18,5	18	78,692	9494	IRCM 103 / 180 M 4b			
3,1	M6 (3m)	18,5	19	71,869	8671	IRCM 103 / 180 M 4b			
4,0	M5 (2m)	22	24	58,778	8433	IRCM 103 / 180 L 4b			
4,5	M5 (2m)	30	27	51,907	10155	IRCM 103 / 200 L 4c			



Vinç sistemleri kaldırma redüktörleri güç ve devir tabloları / Power and ratio table for hoisting applications / Tableau de classification des couples et rapports de réduction pour les applications de levage



D _T Tambur Çapı Drum Diameter <i>Diamètre de l'arbre</i> [mm]	V _h Kaldırma Hızı Lifting Speeds <i>Vitesse de levage</i> [m/min]	Vinç Sınıfı Crane Class <i>Classification de l'application de levage</i> ISO (FEM)	P ₁ Motor Gücü Power <i>Puissance</i> [kW]	n ₂ Çıkış Devri Output Speeds <i>Vitesse de sortie</i> [r.p.m]	i Tahvil Ratio <i>Rapport de réduction</i>	M ₂ Çıkış Momenti Output Torque <i>Couple de sortie</i>	Tip Type <i>Typ</i>		 kg
Ø360	1,3	M6 (3m)	11	7,1	198,333	14227	IRCM 123 / 160 M 4b		
	1,6	M5 (2m)	15	8,7	161,000	15749	IRCM 123 / 160 L 4a		
	1,9	M5 (2m)	15	10	134,473	13154	IRCM 123 / 160 L 4a		
	2,3	M5 (2m)	18,5	12	118,333	14276	IRCM 123 / 180 M 4b		
	2,4	M5 (2m)	18,5	13	105,000	12668	IRCM 123 / 180 M 4b		
	2,8	M5 (2m)	22	15	93,800	13457	IRCM 123 / 180 L 4b		
	3,2	M5 (2m)	30	17	84,259	16484	IRCM 123 / 200 L 4c		
	3,6	M5 (2m)	30	19	73,179	14317	IRCM 123 / 200 L 4c		
	4,1	M5 (2m)	30	22	64,396	12598	IRCM 123 / 200 L 4c		
	4,7	M5 (2m)	37	25	57,140	13787	IRCM 123 / 225 S 4a		
	5,1	M5 (2m)	37	27	51,045	12317	IRCM 123 / 225 S 4a		
5,8	M5 (2m)	45	31	45,853	13456	IRCM 123 / 225 M 4c			
Ø380	1,4	M5 (2m)	11	7,1	198,333	14227	IRCM 123 / 160 M 4b		
	1,7	M5 (2m)	15	8,7	161,000	15749	IRCM 123 / 160 L 4a		
	2,0	M5 (2m)	15	10	134,473	13154	IRCM 123 / 160 L 4a		
	2,4	M5 (2m)	18,5	12	118,333	14276	IRCM 123 / 180 M 4b		
	2,6	M5 (2m)	18,5	13	105,000	12668	IRCM 123 / 180 M 4b		
	3,0	M5 (2m)	22	15	93,800	13457	IRCM 123 / 180 L 4b		
	3,4	M5 (2m)	30	17	84,259	16484	IRCM 123 / 200 L 4c		
	3,8	M5 (2m)	30	19	73,179	14317	IRCM 123 / 200 L 4c		
	4,4	M5 (2m)	37	22	64,396	15538	IRCM 123 / 225 S 4a		
	5,0	M5 (2m)	37	25	57,140	13787	IRCM 123 / 225 S 4a		
	5,4	M5 (2m)	37	27	51,045	12317	IRCM 123 / 225 S 4a		
6,2	M4 (1Am)	45	31	45,853	13456	IRCM 123 / 225 M 4c			
Ø400	1,5	M5 (2m)	11	7,1	198,333	14227	IRCM 123 / 160 M 4b		
	1,8	M4 (1Am)	15	8,7	161,000	15749	IRCM 123 / 160 L 4a		
	2,1	M4 (1Am)	15	10	134,473	13154	IRCM 123 / 160 L 4a		
	2,5	M4 (1Am)	18,5	12	118,333	14276	IRCM 123 / 180 M 4b		
	2,7	M4 (1Am)	22	13	105,000	15064	IRCM 123 / 180 L 4b		
	3,1	M4 (1Am)	22	15	93,800	13457	IRCM 123 / 180 L 4b		
	3,6	M4 (1Am)	30	17	84,259	16484	IRCM 123 / 200 L 4c		
	4,0	M4 (1Am)	30	19	73,179	14317	IRCM 123 / 200 L 4c		
	4,6	M4 (1Am)	37	22	64,396	15538	IRCM 123 / 225 S 4a		
	5,2	M4 (1Am)	37	25	57,140	13787	IRCM 123 / 225 S 4a		
	5,7	M4 (1Am)	45	27	51,045	14980	IRCM 123 / 225 M 4c		
6,5	M4 (1Am)	45	31	45,853	13456	IRCM 123 / 225 M 4c			
Ø420	1,6	M4 (1Am)	11	7,1	198,333	14227	IRCM 123 / 160 M 4b		
	1,9	M4 (1Am)	15	8,7	161,000	15749	IRCM 123 / 160 L 4a		
	2,2	M4 (1Am)	18,5	10	134,473	16223	IRCM 123 / 180 M 4b		
	2,6	M4 (1Am)	18,5	12	118,333	14276	IRCM 123 / 180 M 4b		
	2,9	M4 (1Am)	22	13	105,000	15064	IRCM 123 / 180 L 4b		
	3,3	M4 (1Am)	30	15	93,800	18351	IRCM 123 / 200 L 4c		
	3,7	M4 (1Am)	30	17	84,259	16484	IRCM 123 / 200 L 4c		
	4,2	M4 (1Am)	30	19	73,179	14317	IRCM 123 / 200 L 4c		
	4,8	M4 (1Am)	37	22	64,396	15538	IRCM 123 / 225 S 4a		
	5,5	M4 (1Am)	45	25	57,140	16768	IRCM 123 / 225 M 4c		
	5,9	M4 (1Am)	45	27	51,045	14980	IRCM 123 / 225 M 4c		
6,8	M4 (1Am)	55	31	45,853	16446	IRCM 123 / 250 M 4c			





D _T Tambur Çapı Drum Diameter <i>Diamètre de l'arbre</i> [mm]	V _h Kaldırma Hızı Lifting Speeds <i>Vitesse de levage</i> [m/min]	Vinç Sınıfı Crane Class <i>Classification de l'application de levage</i> ISO (FEM)	P ₁ Motor Gücü Power <i>Puissance</i> [kW]	n ₂ Çıkış Devri Output Speeds <i>Vitesse de sortie</i> [r.p.m]	i Tahvil Ratio <i>Rapport de réduction</i>	M ₂ Çıkış Momenti Output Torque <i>Couple de sortie</i>	Tip Type <i>Typ</i>		 kg
Ø300	0,8	M8 (5m)	7,5	7,1	198,333	9700	IRCM 123 / 132 M 4b		
	1,0	M8 (5m)	7,5	8,7	161,000	7874	IRCM 123 / 132 M 4b		
	1,2	M7 (4m)	9,2	10	134,473	8068	IRCM 123 / 132 M 4c		
	1,4	M7 (4m)	11	12	118,333	8489	IRCM 123 / 160 M 4b		
	1,5	M7 (4m)	11	13	105,000	7532	IRCM 123 / 160 M 4b		
	1,8	M7 (4m)	15	15	93,800	9175	IRCM 123 / 160 L 4a		
	2,0	M7 (4m)	15	17	84,259	8242	IRCM 123 / 160 L 4a		
	2,2	M7 (4m)	18,5	19	73,179	8829	IRCM 123 / 180 M 4b		
	2,6	M7 (4m)	18,5	22	64,396	7769	IRCM 123 / 180 M 4b		
	2,9	M7 (4m)	22	25	57,140	8198	IRCM 123 / 180 L 4b		
	3,2	M7 (4m)	22	27	51,045	7323	IRCM 123 / 180 L 4b		
	3,7	M7 (4m)	30	31	45,853	8971	IRCM 123 / 200 L 4c		
	0,8	M6 (3m)	7,5	7,0	199,476	9756	IRCM 103 / 132 M 4b		
	0,9	M6 (3m)	7,5	7,9	177,284	8671	IRCM 103 / 132 M 4b		
	1,2	M6 (3m)	9,2	10	143,552	8613	IRCM 103 / 132 M 4c		
	1,4	M6 (3m)	11	12	119,126	8545	IRCM 103 / 160 M 4b		
	1,5	M6 (3m)	11	13	109,276	7839	IRCM 103 / 160 M 4b		
	1,8	M6 (3m)	15	15	95,896	9380	IRCM 103 / 160 L 4a		
	2,1	M6 (3m)	15	18	78,692	7698	IRCM 103 / 160 L 4a		
	2,2	M6 (3m)	18,5	19	71,869	8671	IRCM 103 / 180 M 4b		
2,8	M6 (3m)	22	24	58,778	8433	IRCM 103 / 180 L 4b			
3,2	M6 (3m)	22	27	51,907	7447	IRCM 103 / 180 L 4b			
Ø320	0,9	M7 (4m)	7,5	7,1	198,333	9700	IRCM 123 / 132 M 4b		
	1,1	M7 (4m)	9,2	8,7	161,000	9659	IRCM 123 / 132 M 4c		
	1,3	M7 (4m)	9,2	10	134,473	8068	IRCM 123 / 132 M 4c		
	1,5	M7 (4m)	11	12	118,333	8489	IRCM 123 / 160 M 4b		
	1,6	M7 (4m)	15	13	105,000	10271	IRCM 123 / 160 L 4a		
	1,9	M7 (4m)	15	15	93,800	9175	IRCM 123 / 160 L 4a		
	2,1	M7 (4m)	15	17	84,259	8242	IRCM 123 / 160 L 4a		
	2,4	M7 (4m)	18,5	19	73,179	8829	IRCM 123 / 180 M 4b		
	2,8	M7 (4m)	22	22	64,396	9239	IRCM 123 / 180 M 4b		
	3,1	M7 (4m)	22	25	57,140	8198	IRCM 123 / 180 L 4b		
	3,4	M7 (4m)	30	27	51,045	9986	IRCM 123 / 200 L 4c		
	3,9	M7 (4m)	30	31	45,853	8971	IRCM 123 / 200 L 4c		
	0,9	M6 (3m)	7,5	7,0	199,476	9756	IRCM 103 / 132 M 4b		
	1,0	M6 (3m)	7,5	7,9	177,284	8671	IRCM 103 / 132 M 4b		
	1,2	M6 (3m)	9,2	10	143,552	8613	IRCM 103 / 132 M 4c		
	1,5	M6 (3m)	11	12	119,126	8545	IRCM 103 / 160 M 4b		
	1,6	M6 (3m)	15	13	109,276	10689	IRCM 103 / 160 L 4a		
	1,9	M6 (3m)	15	15	95,896	9380	IRCM 103 / 160 L 4a		
	2,3	M6 (3m)	18,5	18	78,692	9494	IRCM 103 / 180 M 4b		
	2,4	M6 (3m)	18,5	19	71,869	8671	IRCM 103 / 180 M 4b		
3,0	M6 (3m)	22	24	58,778	8433	IRCM 103 / 180 L 4b			
3,4	M5 (2m)	30	27	51,907	10155	IRCM 103 / 200 L 4c			
Ø340	0,9	M7 (4m)	7,5	7,1	198,333	9700	IRCM 123 / 132 M 4b		
	1,2	M7 (4m)	9,2	8,7	161,000	9659	IRCM 123 / 132 M 4c		
	1,3	M7 (4m)	9,2	10	134,473	8068	IRCM 123 / 132 M 4c		
	1,6	M7 (4m)	15	12	118,333	11575	IRCM 123 / 160 L 4a		
	1,7	M7 (4m)	15	13	105,000	10271	IRCM 123 / 160 L 4a		
	2,0	M7 (4m)	15	15	93,800	9175	IRCM 123 / 160 L 4a		
	2,3	M7 (4m)	18,5	17	84,259	10165	IRCM 123 / 180 M 4b		
	2,5	M7 (4m)	18,5	19	73,179	8829	IRCM 123 / 180 M 4b		
	2,9	M7 (4m)	22	22	64,396	9239	IRCM 123 / 180 L 4b		
	3,3	M7 (4m)	30	25	57,140	11179	IRCM 123 / 200 L 4c		
	3,6	M7 (4m)	30	27	51,045	9986	IRCM 123 / 200 L 4c		
	4,1	M7 (4m)	30	31	45,853	8971	IRCM 123 / 200 L 4c		



Vinç sistemleri kaldırma redüktörleri güç ve devir tabloları / Power and ratio table for hoisting applications / Tableau de classification des couples et rapports de réduction pour les applications de levage



D _T Tambur Çapı Drum Diameter <i>Diamètre de l'arbre</i> [mm]	V _h Kaldırma Hızı Lifting Speeds <i>Vitesse de levage</i> [m/min]	Vinç Sınıfı Crane Class <i>Classification de l'application de levage</i> ISO (FEM)	P ₁ Motor Gücü Power <i>Puissance</i> [kW]	n ₂ Çıkış Devri Output Speeds <i>Vitesse de sortie</i> [r.p.m]	i Tahvil Ratio <i>Rapport de réduction</i>	M ₂ Çıkış Momenti Output Torque <i>Couple de sortie</i>	Tip Type <i>Typ</i>		 kg
Ø360	0,9	M6 (3m)	7,5	7,0	199,476	9756	IRCM 103 / 132 M 4b		
	1,1	M6 (3m)	7,5	7,9	177,284	8671	IRCM 103 / 132 M 4b		
	1,3	M6 (3m)	9,2	10	143,552	8613	IRCM 103 / 132 M 4c		
	1,6	M6 (3m)	15	12	119,126	11653	IRCM 103 / 160 L 4a		
	1,7	M6 (3m)	15	13	109,276	10689	IRCM 103 / 160 L 4a		
	2,0	M6 (3m)	15	15	95,896	9380	IRCM 103 / 160 L 4a		
	2,4	M6 (3m)	18,5	18	78,692	9494	IRCM 103 / 180 M 4b		
	2,5	M5 (2m)	18,5	19	71,869	8671	IRCM 103 / 180 M 4b		
	3,2	M5 (2m)	30	24	58,778	11499	IRCM 103 / 200 L 4c		
	3,6	M5 (2m)	30	27	51,907	10155	IRCM 103 / 200 L 4c		
	1,0	M7 (4m)	7,5	7,1	198,333	9700	IRCM 123 / 132 M 4b		
	1,2	M7 (4m)	9,2	8,7	161,000	9659	IRCM 123 / 132 M 4c		
	1,4	M7 (4m)	11	10	134,473	9646	IRCM 123 / 160 M 4b		
	1,7	M7 (4m)	15	12	118,333	11575	IRCM 123 / 160 L 4a		
	1,8	M7 (4m)	15	13	105,000	10271	IRCM 123 / 160 L 4a		
	2,1	M7 (4m)	15	15	93,800	9175	IRCM 123 / 160 L 4a		
	2,4	M7 (4m)	18,5	17	84,259	10165	IRCM 123 / 180 M 4b		
	2,7	M7 (4m)	18,5	19	73,179	8829	IRCM 123 / 180 M 4b		
3,1	M7 (4m)	22	22	64,396	9239	IRCM 123 / 180 L 4b			
3,5	M7 (4m)	30	25	57,140	11179	IRCM 123 / 200 L 4c			
3,8	M7 (4m)	30	27	51,045	9986	IRCM 123 / 200 L 4c			
4,4	M7 (4m)	37	31	45,853	11064	IRCM 123 / 225 S 4a			
1,0	M5 (2m)	7,5	7,0	199,476	9756	IRCM 103 / 132 M 4b			
1,1	M5 (2m)	9,2	7,9	177,284	10636	IRCM 103 / 132 M 4c			
1,4	M5 (2m)	11	10	143,552	10298	IRCM 103 / 160 M 4b			
1,7	M5 (2m)	15	12	119,126	11653	IRCM 103 / 160 L 4a			
1,8	M5 (2m)	15	13	109,276	10689	IRCM 103 / 160 L 4a			
2,1	M5 (2m)	15	15	95,896	9380	IRCM 103 / 160 L 4a			
2,5	M5 (2m)	18,5	18	78,692	9494	IRCM 103 / 180 M 4b			
2,7	M5 (2m)	18,5	19	71,869	8671	IRCM 103 / 180 M 4b			
3,4	M5 (2m)	30	24	58,778	11499	IRCM 103 / 200 L 4c			
3,8	M4 (1Am)	30	27	51,907	10155	IRCM 103 / 200 L 4c			
Ø380	1,1	M7 (4m)	7,5	7,1	198,333	9700	IRCM 123 / 132 M 4b		
	1,3	M7 (4m)	9,2	8,7	161,000	9659	IRCM 123 / 132 M 4c		
	1,5	M6 (3m)	11	10	134,473	9646	IRCM 123 / 160 M 4b		
	1,8	M6 (3m)	15	12	118,333	11575	IRCM 123 / 160 L 4a		
	1,9	M6 (3m)	15	13	105,000	10271	IRCM 123 / 160 L 4a		
	2,2	M6 (3m)	18,5	15	93,800	11316	IRCM 123 / 180 M 4b		
	2,5	M6 (3m)	18,5	17	84,259	10165	IRCM 123 / 180 M 4b		
	2,8	M6 (3m)	22	19	73,179	10499	IRCM 123 / 180 L 4b		
	3,3	M6 (3m)	30	22	64,396	12598	IRCM 123 / 200 L 4c		
	3,7	M6 (3m)	30	25	57,140	11179	IRCM 123 / 200 L 4c		
	4,0	M6 (3m)	30	27	51,045	9986	IRCM 123 / 200 L 4c		
	4,6	M6 (3m)	37	31	45,853	11064	IRCM 123 / 225 S 4a		
	1,0	M5 (2m)	7,5	7,0	199,476	9756	IRCM 103 / 132 M 4b		
	1,2	M5 (2m)	9,2	7,9	177,284	10636	IRCM 103 / 132 M 4c		
	1,5	M5 (2m)	11	10	143,552	10298	IRCM 103 / 160 M 4b		
	1,8	M5 (2m)	15	12	119,126	11653	IRCM 103 / 160 L 4a		
	1,9	M5 (2m)	15	13	109,276	10689	IRCM 103 / 160 L 4a		
	2,2	M5 (2m)	18,5	15	95,896	11569	IRCM 103 / 180 M 4b		
	2,7	M5 (2m)	18,5	18	78,692	9494	IRCM 103 / 180 M 4b		
	2,8	M5 (2m)	22	19	71,869	10311	IRCM 103 / 180 L 4b		
	3,6	M4 (1Am)	30	24	58,778	11499	IRCM 103 / 200 L 4c		
	4,0	M4 (1Am)	30	27	51,907	10155	IRCM 103 / 200 L 4c		



D _T Tambur Çapı Drum Diameter <i>Diamètre de l'arbre</i> [mm]	V _h Kaldırma Hızı Lifting Speeds <i>Vitesse de levage</i> [m/min]	Vinç Sınıfı Crane Class <i>Classification de l'application de levage</i> ISO (FEM)	P ₁ Motor Gücü Power <i>Puissance</i> [kW]	n ₂ Çıkış Devri Output Speeds <i>Vitesse de sortie</i> [r.p.m]	i Tahvil Ratio <i>Rapport de réduction</i>	M ₂ Çıkış Momenti Output Torque <i>Couple de sortie</i>	Tip Type <i>Typ</i>		 kg
Ø400	1,1	M6 (3m)	9,2	7,1	198,333	11899	IRCM 123 / 132 M 4c		
	1,4	M6 (3m)	11	8,7	161,000	11549	IRCM 123 / 160 M 4b		
	1,6	M6 (3m)	11	10	134,473	9646	IRCM 123 / 160 M 4b		
	1,9	M6 (3m)	15	12	118,333	11575	IRCM 123 / 160 L 4a		
	2,0	M6 (3m)	15	13	105,000	10271	IRCM 123 / 160 L 4a		
	2,4	M6 (3m)	18,5	15	93,800	11316	IRCM 123 / 180 M 4b		
	2,7	M6 (3m)	18,5	17	84,259	10165	IRCM 123 / 180 M 4b		
	3,0	M6 (3m)	22	19	73,179	10499	IRCM 123 / 180 L 4b		
	3,5	M6 (3m)	30	22	64,396	12598	IRCM 123 / 200 L 4c		
	3,9	M6 (3m)	30	25	57,140	11179	IRCM 123 / 200 L 4c		
	4,2	M6 (3m)	30	27	51,045	9986	IRCM 123 / 200 L 4c		
	4,9	M6 (3m)	37	31	45,853	11064	IRCM 123 / 225 S 4a		
	1,1	M4 (1Am)	9,2	7,0	199,476	11968	IRCM 103 / 132 M 4c		
	1,2	M4 (1Am)	9,2	7,9	177,284	10636	IRCM 103 / 132 M 4c		
	1,5	M4 (1Am)	11	10	143,552	10298	IRCM 103 / 160 M 4b		
	1,9	M4 (1Am)	15	12	119,126	11653	IRCM 103 / 160 L 4a		
	2,0	M4 (1Am)	15	13	109,276	10689	IRCM 103 / 160 L 4a		
	2,4	M4 (1Am)	18,5	15	95,896	11569	IRCM 103 / 180 M 4b		
	2,8	M4 (1Am)	22	18	78,692	11290	IRCM 103 / 180 L 4b		
	3,0	M4 (1Am)	22	19	71,869	10311	IRCM 103 / 180 L 4b		
3,8	M4 (1Am)	30	24	58,778	11499	IRCM 103 / 200 L 4c			
4,2	M3 (1Bm)	30	27	51,907	10155	IRCM 103 / 200 L 4c			
Ø420	1,2	M6 (3m)	9,2	7,1	198,333	11899	IRCM 123 / 132 M 4c		
	1,4	M6 (3m)	11	8,7	161,000	11549	IRCM 123 / 160 M 4b		
	1,6	M6 (3m)	15	10	134,473	13154	IRCM 123 / 160 L 4a		
	2,0	M6 (3m)	15	12	118,333	11575	IRCM 123 / 160 L 4a		
	2,1	M6 (3m)	15	13	105,000	10271	IRCM 123 / 160 L 4a		
	2,5	M6 (3m)	18,5	15	93,800	11316	IRCM 123 / 180 M 4b		
	2,8	M6 (3m)	22	17	84,259	12088	IRCM 123 / 180 L 4b		
	3,1	M6 (3m)	22	19	73,179	10499	IRCM 123 / 180 L 4b		
	3,6	M6 (3m)	30	22	64,396	12598	IRCM 123 / 200 L 4c		
	4,1	M6 (3m)	30	25	57,140	11179	IRCM 123 / 200 L 4c		
	4,5	M6 (3m)	37	27	51,045	12317	IRCM 123 / 225 S 4a		
	5,1	M6 (3m)	37	31	45,853	11064	IRCM 123 / 225 S 4a		
Ø440	1,2	M6 (3m)	9,2	7,1	198,333	11899	IRCM 123 / 132 M 4c		
	1,5	M6 (3m)	11	8,7	161,000	11549	IRCM 123 / 160 M 4b		
	1,7	M6 (3m)	15	10	134,473	13154	IRCM 123 / 160 L 4a		
	2,1	M6 (3m)	15	12	118,333	11575	IRCM 123 / 160 L 4a		
	2,2	M6 (3m)	18,5	13	105,000	12668	IRCM 123 / 180 M 4b		
	2,6	M6 (3m)	18,5	15	93,800	11316	IRCM 123 / 180 M 4b		
	2,9	M6 (3m)	22	17	84,259	12088	IRCM 123 / 180 L 4b		
	3,3	M6 (3m)	30	19	73,179	14317	IRCM 123 / 200 L 4c		
	3,8	M6 (3m)	30	22	64,396	12598	IRCM 123 / 200 L 4c		
	4,3	M6 (3m)	30	25	57,140	11179	IRCM 123 / 200 L 4c		
	4,7	M6 (3m)	37	27	51,045	12317	IRCM 123 / 225 S 4a		
	5,4	M6 (3m)	37	31	45,853	11064	IRCM 123 / 225 S 4a		



Vinc sistemleri kaldırma redüktörleri güç ve devir tabloları / Power and ratio table for hoisting applications / Tableau de classification des couples et rapports de réduction pour les applications de levage

D _T Tambur Çapı Drum Diameter <i>Diamètre de l'arbre</i> [mm]	V _h Kaldırma Hızı Lifting Speeds <i>Vitesse de levage</i> [m/min]	Vinc Sınıfı Crane Class <i>Classification de l'application de levage</i> ISO (FEM)	P ₁ Motor Gücü Power <i>Puissance</i> [kW]	n ₂ Çıkış Devri Output Speeds <i>Vitesse de sortie</i> [r.p.m]	i Tahvil Ratio <i>Rapport de réduction</i>	M ₂ Çıkış Momenti Output Torque <i>Couple de sortie</i>	Tip Type <i>Typ</i>		 kg
Ø320	0,9	M6 (3m)	9,2	7,1	198,333	11899	IRCM 123 / 132 M 4c		
	1,1	M6 (3m)	11	8,7	161,000	11549	IRCM 123 / 160 M 4b		
	1,3	M6 (3m)	11	10	134,473	9646	IRCM 123 / 160 M 4b		
	1,5	M6 (3m)	15	12	118,333	11575	IRCM 123 / 160 L 4a		
	1,6	M6 (3m)	15	13	105,000	10271	IRCM 123 / 160 L 4a		
	1,9	M6 (3m)	18,5	15	93,800	11316	IRCM 123 / 180 M 4b		
	2,1	M6 (3m)	18,5	17	84,259	10165	IRCM 123 / 180 M 4b		
	2,4	M6 (3m)	22	19	73,179	10499	IRCM 123 / 180 L 4b		
	2,8	M6 (3m)	30	22	64,396	12598	IRCM 123 / 200 L 4c		
	3,1	M6 (3m)	30	25	57,140	11179	IRCM 123 / 200 L 4c		
	3,4	M6 (3m)	30	27	51,045	9986	IRCM 123 / 200 L 4c		
	3,9	M6 (3m)	37	31	45,853	11064	IRCM 123 / 225 S 4a		
	0,9	M4 (1Am)	9,2	7,0	199,476	11968	IRCM 103 / 132 M 4c		
	1,0	M4 (1Am)	9,2	7,9	177,284	10636	IRCM 103 / 132 M 4c		
	1,2	M4 (1Am)	11	10	143,552	10298	IRCM 103 / 160 M 4b		
	1,5	M4 (1Am)	15	12	119,126	11653	IRCM 103 / 160 L 4a		
	1,6	M4 (1Am)	15	13	109,276	10689	IRCM 103 / 160 L 4a		
	1,9	M4 (1Am)	18,5	15	95,896	11569	IRCM 103 / 180 M 4b		
	2,3	M4 (1Am)	22	18	78,692	11290	IRCM 103 / 180 L 4b		
	2,4	M4 (1Am)	22	19	71,869	10311	IRCM 103 / 180 L 4b		
3,0	M4 (1Am)	30	24	58,778	11499	IRCM 103 / 200 L 4c			
3,4	M3 (1Bm)	30	27	51,907	10155	IRCM 103 / 200 L 4c			
Ø340	0,9	M6 (3m)	9,2	7,1	198,333	11899	IRCM 123 / 132 M 4c		
	1,2	M6 (3m)	11	8,7	161,000	11549	IRCM 123 / 160 M 4b		
	1,3	M6 (3m)	15	10	134,473	13154	IRCM 123 / 160 L 4a		
	1,6	M6 (3m)	15	12	118,333	11575	IRCM 123 / 160 L 4a		
	1,7	M6 (3m)	15	13	105,000	10271	IRCM 123 / 160 L 4a		
	2,0	M6 (3m)	18,5	15	93,800	11316	IRCM 123 / 180 M 4b		
	2,3	M6 (3m)	22	17	84,259	12088	IRCM 123 / 180 L 4b		
	2,5	M6 (3m)	22	19	73,179	10499	IRCM 123 / 180 L 4b		
	2,9	M6 (3m)	30	22	64,396	12598	IRCM 123 / 200 L 4c		
	3,3	M6 (3m)	30	25	57,140	11179	IRCM 123 / 200 L 4c		
	3,6	M6 (3m)	37	27	51,045	12317	IRCM 123 / 225 S 4a		
	4,1	M6 (3m)	37	31	45,853	11064	IRCM 123 / 225 S 4a		
Ø360	1,0	M6 (3m)	9,2	7,1	198,333	11899	IRCM 123 / 132 M 4c		
	1,2	M6 (3m)	11	8,7	161,000	11549	IRCM 123 / 160 M 4b		
	1,4	M6 (3m)	15	10	134,473	13154	IRCM 123 / 160 L 4a		
	1,7	M6 (3m)	15	12	118,333	11575	IRCM 123 / 160 L 4a		
	1,8	M6 (3m)	18,5	13	105,000	12668	IRCM 123 / 180 M 4b		
	2,1	M6 (3m)	18,5	15	93,800	11316	IRCM 123 / 180 M 4b		
	2,4	M6 (3m)	22	17	84,259	12088	IRCM 123 / 180 L 4b		
	2,7	M6 (3m)	30	19	73,179	14317	IRCM 123 / 200 L 4c		
	3,1	M6 (3m)	30	22	64,396	12598	IRCM 123 / 200 L 4c		
	3,5	M6 (3m)	37	25	57,140	13787	IRCM 123 / 225 S 4a		
	3,8	M6 (3m)	37	27	51,045	12317	IRCM 123 / 225 S 4a		
	4,4	M5 (2m)	45	31	45,853	13456	IRCM 123 / 225 M 4c		
Ø380	1,1	M6 (3m)	9,2	7,1	198,333	11899	IRCM 123 / 132 M 4c		
	1,3	M5 (2m)	15	8,7	161,000	15749	IRCM 123 / 160 L 4a		
	1,5	M5 (2m)	15	10	134,473	13154	IRCM 123 / 160 L 4a		
	1,8	M5 (2m)	18,5	12	118,333	14276	IRCM 123 / 180 M 4b		
	1,9	M5 (2m)	18,5	13	105,000	12668	IRCM 123 / 180 M 4b		
	2,2	M5 (2m)	22	15	93,800	13457	IRCM 123 / 180 L 4b		
	2,5	M5 (2m)	22	17	84,259	12088	IRCM 123 / 180 L 4b		
	2,8	M5 (2m)	30	19	73,179	14317	IRCM 123 / 200 L 4c		
	3,3	M5 (2m)	30	22	64,396	12598	IRCM 123 / 200 L 4c		
	3,7	M5 (2m)	37	25	57,140	13787	IRCM 123 / 225 S 4a		
	4,0	M5 (2m)	37	27	51,045	12317	IRCM 123 / 225 S 4a		
	4,6	M5 (2m)	45	31	45,853	13456	IRCM 123 / 225 M 4c		



D _T Tambur Çapı Drum Diameter <i>Diamètre de l'arbre</i> [mm]	V _h Kaldırma Hızı Lifting Speeds <i>Vitesse de levage</i> [m/min]	Vinç Sınıfı Crane Class <i>Classification de l'application de levage</i> ISO (FEM)	P ₁ Motor Gücü Power <i>Puissance</i> [kW]	n ₂ Çıkış Devri Output Speeds <i>Vitesse de sortie</i> [r.p.m]	i Tahvil Ratio <i>Rapport de réduction</i>	M ₂ Çıkış Momenti Output Torque <i>Couple de sortie</i>	Tip Type <i>Typ</i>		 kg
Ø400	1,1	M5 (2m)	11	7,1	198,333	14227	IRCM 123 / 160 M 4b		
	1,4	M5 (2m)	15	8,7	161,000	15749	IRCM 123 / 160 L 4a		
	1,6	M5 (2m)	15	10	134,473	13154	IRCM 123 / 160 L 4a		
	1,9	M5 (2m)	18,5	12	118,333	14276	IRCM 123 / 180 M 4b		
	2,0	M5 (2m)	18,5	13	105,000	12668	IRCM 123 / 180 M 4b		
	2,4	M5 (2m)	22	15	93,800	13457	IRCM 123 / 180 L 4b		
	2,7	M5 (2m)	30	17	84,259	16484	IRCM 123 / 200 L 4c		
	3,0	M5 (2m)	30	19	73,179	14317	IRCM 123 / 200 L 4c		
	3,5	M5 (2m)	30	22	64,396	12598	IRCM 123 / 200 L 4c		
	3,9	M5 (2m)	37	25	57,140	13787	IRCM 123 / 225 S 4a		
	4,2	M5 (2m)	37	27	51,045	12317	IRCM 123 / 225 S 4a		
4,9	M4 (1Am)	45	31	45,853	13456	IRCM 123 / 225 M 4c			
Ø420	1,2	M5 (2m)	11	7,1	198,333	14227	IRCM 123 / 160 M 4b		
	1,4	M5 (2m)	15	8,7	161,000	15749	IRCM 123 / 160 L 4a		
	1,6	M4 (1Am)	15	10	134,473	13154	IRCM 123 / 160 L 4a		
	2,0	M4 (1Am)	18,5	12	118,333	14276	IRCM 123 / 180 M 4b		
	2,1	M4 (1Am)	18,5	13	105,000	12668	IRCM 123 / 180 M 4b		
	2,5	M4 (1Am)	22	15	93,800	13457	IRCM 123 / 180 L 4b		
	2,8	M4 (1Am)	30	17	84,259	16484	IRCM 123 / 200 L 4c		
	3,1	M4 (1Am)	30	19	73,179	14317	IRCM 123 / 200 L 4c		
	3,6	M4 (1Am)	37	22	64,396	15538	IRCM 123 / 225 S 4a		
	4,1	M4 (1Am)	37	25	57,140	13787	IRCM 123 / 225 S 4a		
	4,5	M4 (1Am)	45	27	51,045	14980	IRCM 123 / 225 M 4c		
5,1	M4 (1Am)	45	31	45,853	13456	IRCM 123 / 225 M 4c			
Ø440	1,2	M4 (1Am)	11	7,1	198,333	14227	IRCM 123 / 160 M 4b		
	1,5	M4 (1Am)	15	8,7	161,000	15749	IRCM 123 / 160 L 4a		
	1,7	M4 (1Am)	15	10	134,473	13154	IRCM 123 / 160 L 4a		
	2,1	M4 (1Am)	18,5	12	118,333	14276	IRCM 123 / 180 M 4b		
	2,2	M4 (1Am)	22	13	105,000	15064	IRCM 123 / 180 L 4b		
	2,6	M4 (1Am)	30	15	93,800	18351	IRCM 123 / 200 L 4c		
	2,9	M4 (1Am)	30	17	84,259	16484	IRCM 123 / 200 L 4c		
	3,3	M4 (1Am)	30	19	73,179	14317	IRCM 123 / 200 L 4c		
	3,8	M4 (1Am)	37	22	64,396	15538	IRCM 123 / 225 S 4a		
	4,3	M4 (1Am)	45	25	57,140	16768	IRCM 123 / 225 M 4c		
	4,7	M4 (1Am)	45	27	51,045	14980	IRCM 123 / 225 M 4c		
5,4	M4 (1Am)	55	31	45,853	16446	IRCM 123 / 250 M 4c			



Vinç Sistemleri Kaldırma Redüktörleri Ölçü Sayfaları

Dimensions Pages
Dimensions



İRCM 73

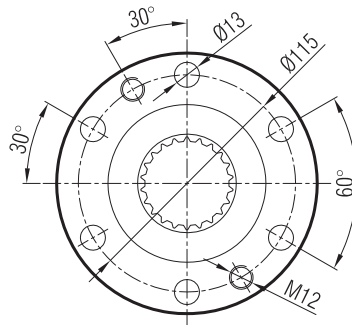
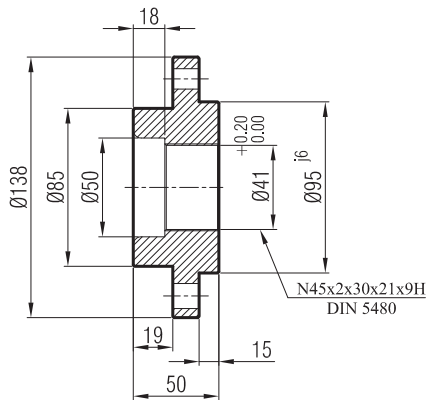
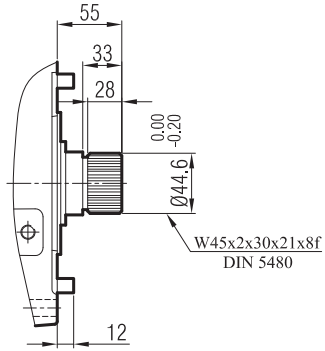
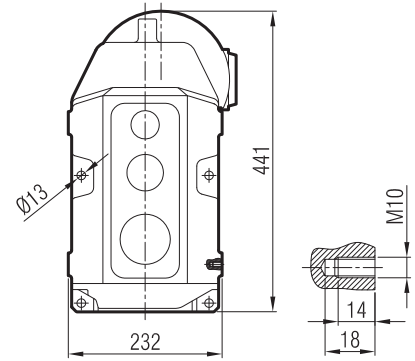
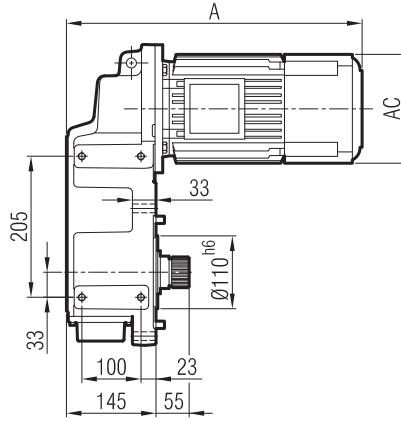
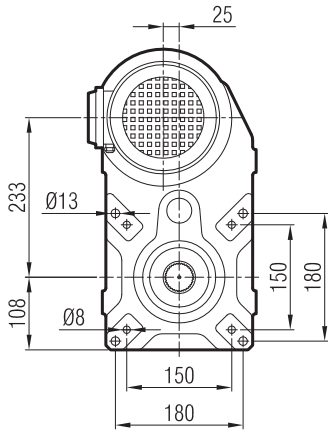

	63	71	80	90 S	90 L	100	112	132 S	132 M	160 M	160 L	180 M	180 L				
A		421	462	509	534	598	638	724									
AC		138	158	193	193	217	232	279									



İRCPM 73

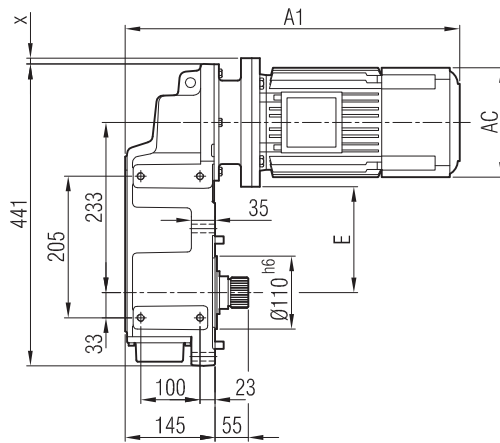
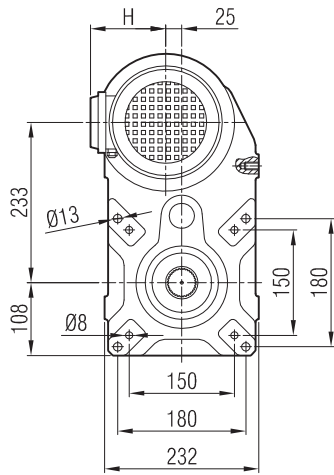

	A1	AC	E	H	x
71/B5	496	132	153	111	-
80/B5	539	158	133	118	-
90 S/B5	573	193	133	132	-
90 L/B5	598	193	133	132	-
100/B5	658	217	108	141	25
112/B5	695	232	108	149	25

"A1" Ölçüsü Frenli Motorlar içindir.
Dimension "A1" is for motors with brake
Maß "A1" ist für Motoren mit Bremse

İRCP 73

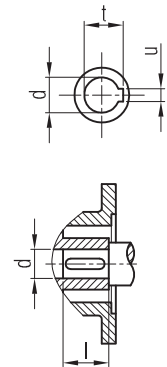
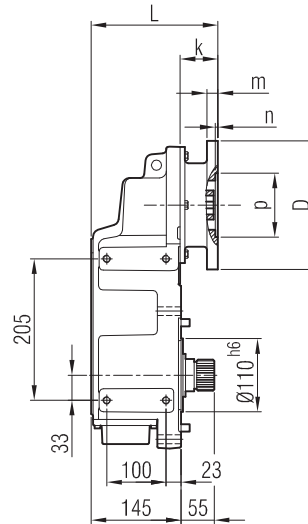
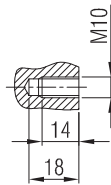
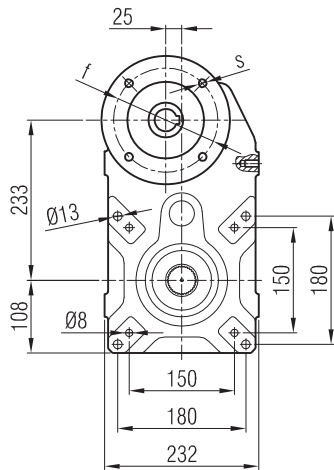

	L	Øp	Øf	ØD	s	k	m	n	Ød	l	t	u
71/B5	200	110	130	160	M8	55	10	4	14	30	16.3	5
80/B5	212	130	165	200	M10	67	12	5	19	40	21.8	6
90/B5	212	130	165	200	M10	67	12	5	24	50	27.3	8
100/B5	217	180	215	250	M12	71.5	14	5	28	60	31.3	8
112/B5	217	180	215	250	M12	71.5	14	5	28	60	31.3	8

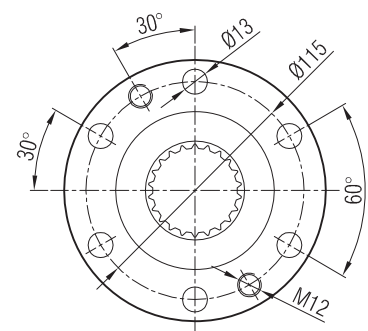
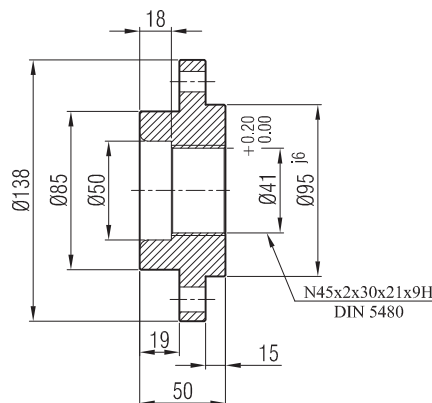
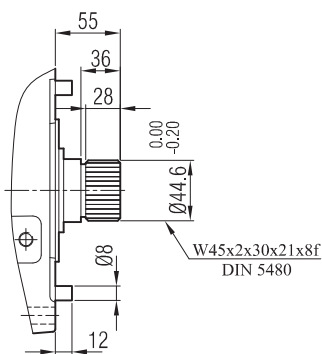



İRCM 83

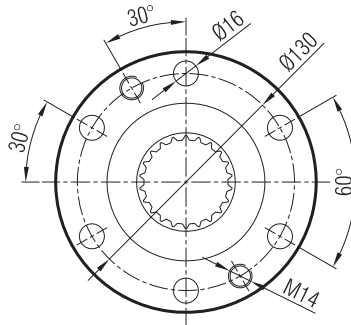
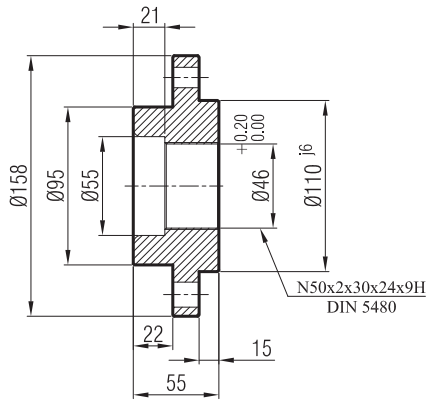
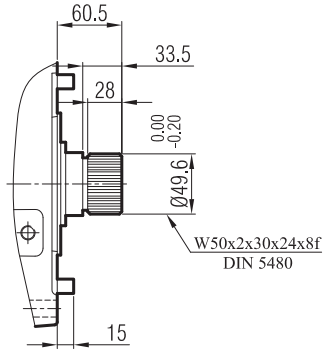
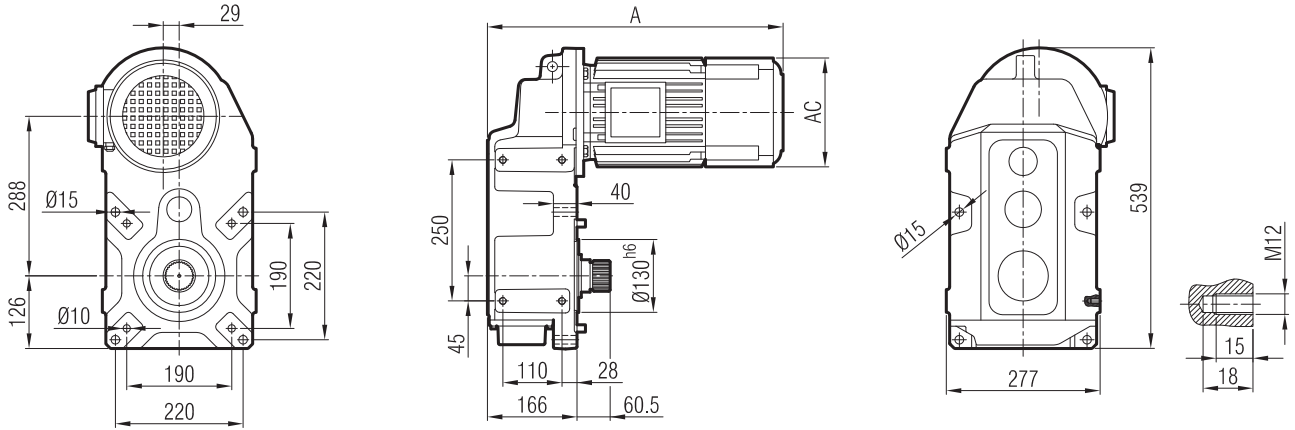

	63	71	80	90 S	90 L	100	112	132 S	132 M						
A				517	542	605	644	741	779						
AC				193	193	217	232	279	279						



İRCPM 83

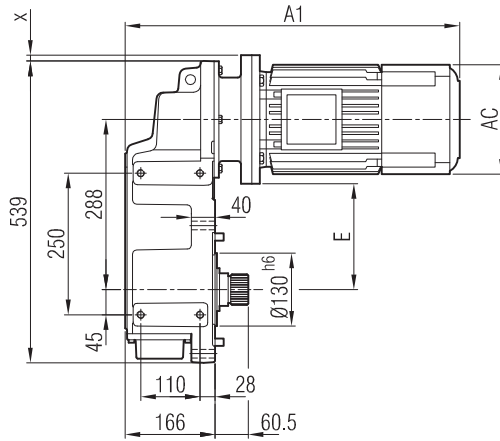
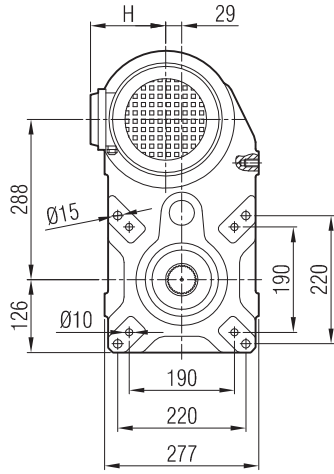

	A1	AC	E	H	x
90 S/B5	592	193	188	132	-
90 L/B5	617	193	188	141	-
100/B5	680	217	163	149	-
112/B5	717	232	163	182	-
132 S/B5	820	279	138	182	25
132 M/B5	858	279	138	225	25

"A1" Ölçüsü Frenli Motorlar içindir.
Dimension "A1" is for motors with brake
Maß "A1" ist für Motoren mit Bremse

İRCP 83

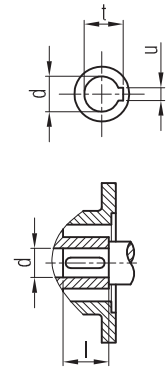
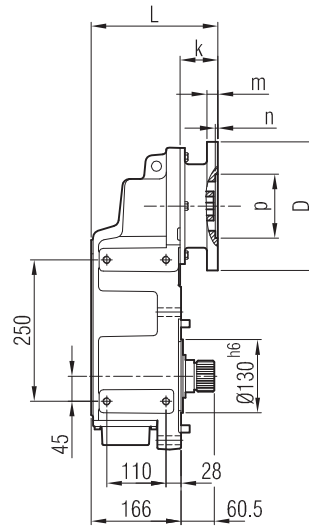
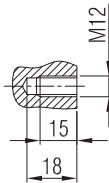
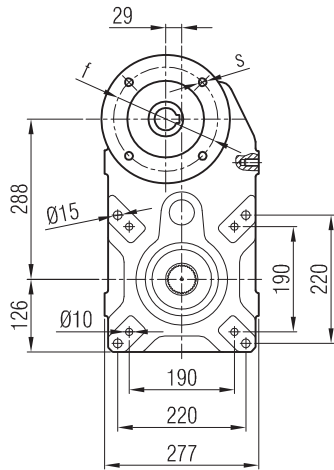

	L	Øp	Øf	ØD	s	k	m	n	Ød	l	t	u
90/B5	231	130	165	200	M10	67	12	5	24	50	27.3	8
100/B5	239	180	215	250	M12	74	14	5	28	60	31.3	8
112/B5	239	180	215	250	M12	74	14	5	28	60	31.3	8
132/B5	260	230	265	300	M12	95	17	6	38	80	41.3	10

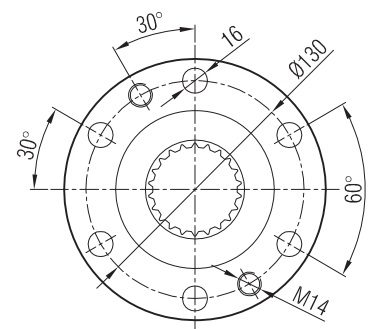
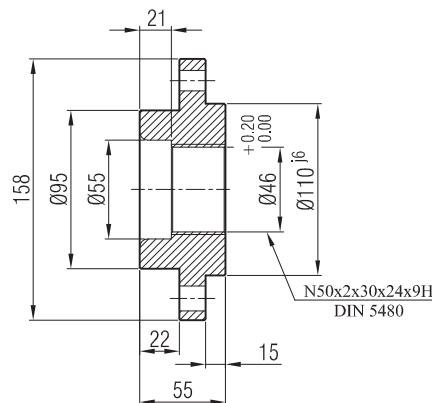
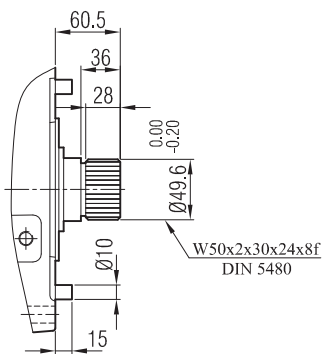



İRCM 93

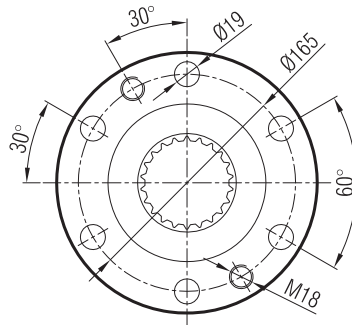
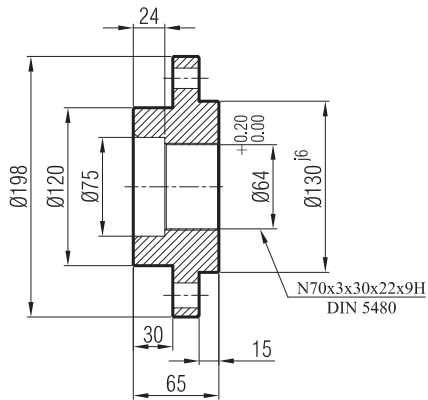
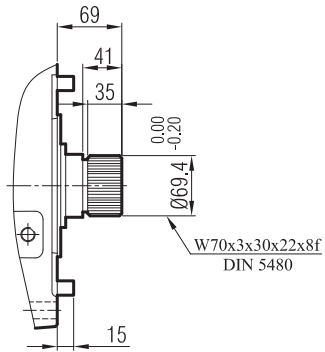
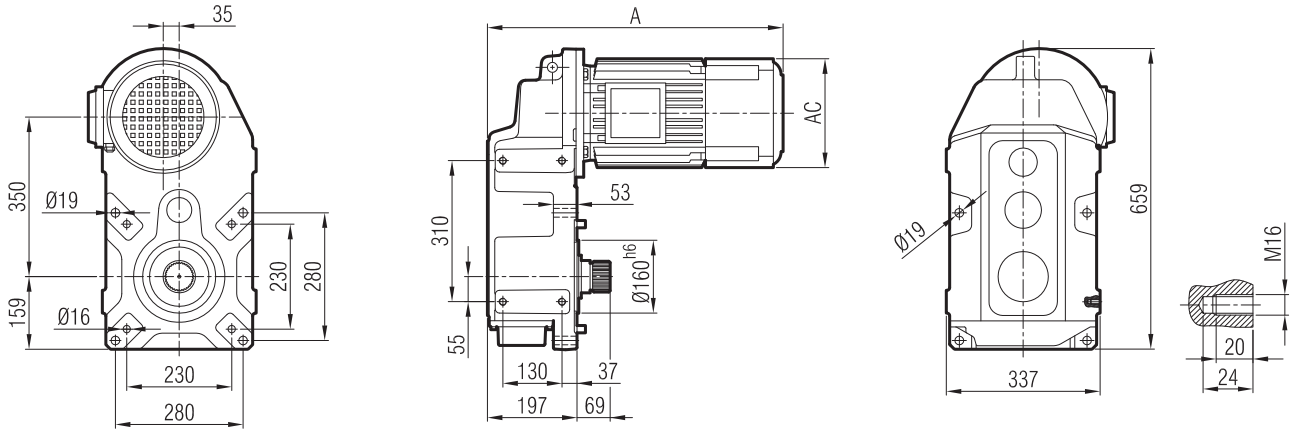

	63	71	80	90 S	90 L	100	112	132 S	132 M	160 M	160 L	180 M	180 L				
A						625	665	755	793	898	942	955	993				
AC						217	232	279	279	323	323	370	370				



İRCPM 93

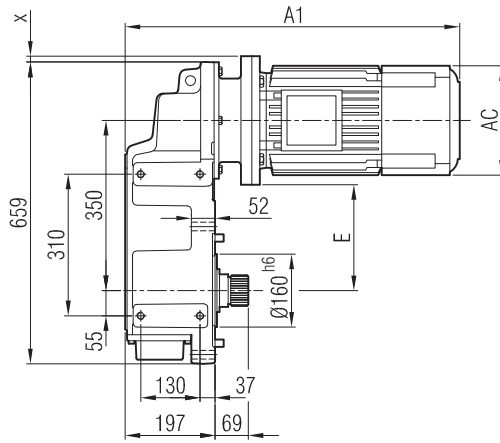
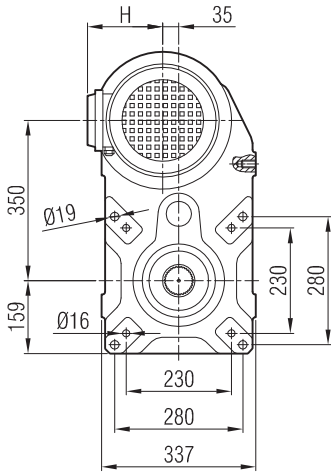

	A1	AC	E	H	x
100/B5	694	217	225	141	-
112/B5	731	232	225	149	-
132 S/B5	850	279	200	182	-
132 M/B5	888	279	200	182	-
160 M/B5	991	323	175	225	25
160 L/B5	1035	323	175	225	25
180 M/B5	1048	370	175	248	25
180 L/B5	1086	370	175	248	25

"A1" Ölçüsü Frenli Motorlar içindir.
Dimension "A1" is for motors with brake
Maß "A1" ist für Motoren mit Bremse

İRCP 93

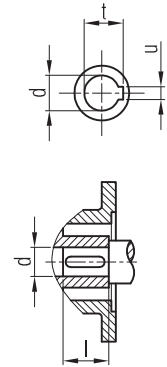
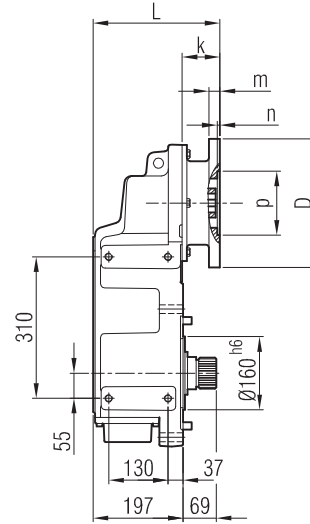
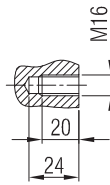
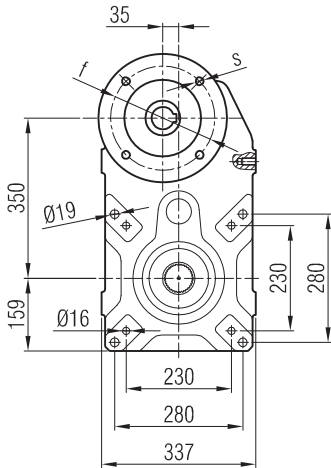

	L	Øp	Øf	ØD	s	k	m	n	Ød	l	t	u
100/B5	253	180	215	250	M12	58	14	5	28	60	31.3	8
112/B5	253	180	215	250	M12	58	14	5	28	60	31.3	8
132/B5	290	230	265	300	M12	95	17	6	38	80	41.3	10
160/B5	306	250	300	350	M14	111	18	6.5	42	110	45.3	12
180/B5	306	250	300	350	M14	111	18	6.5	48	110	51.8	14

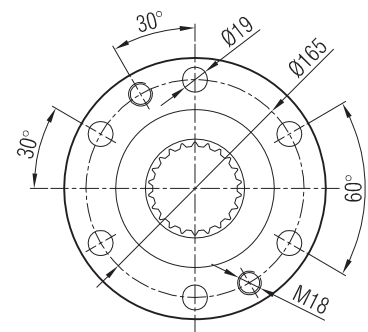
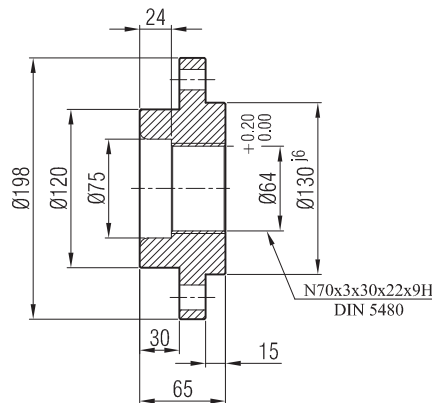
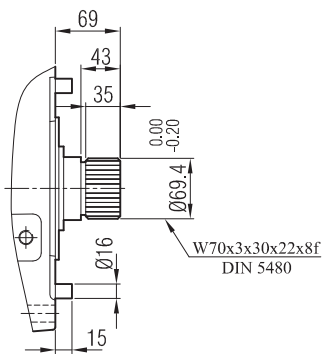



İRCM 103

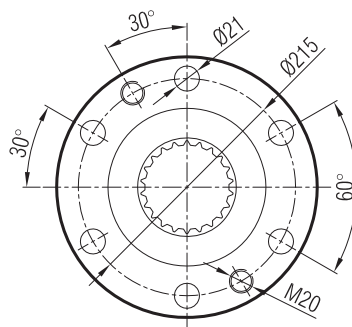
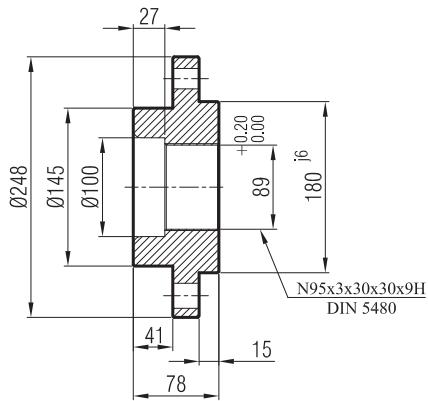
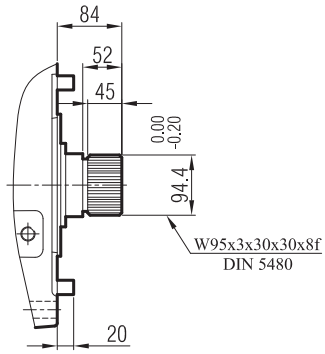
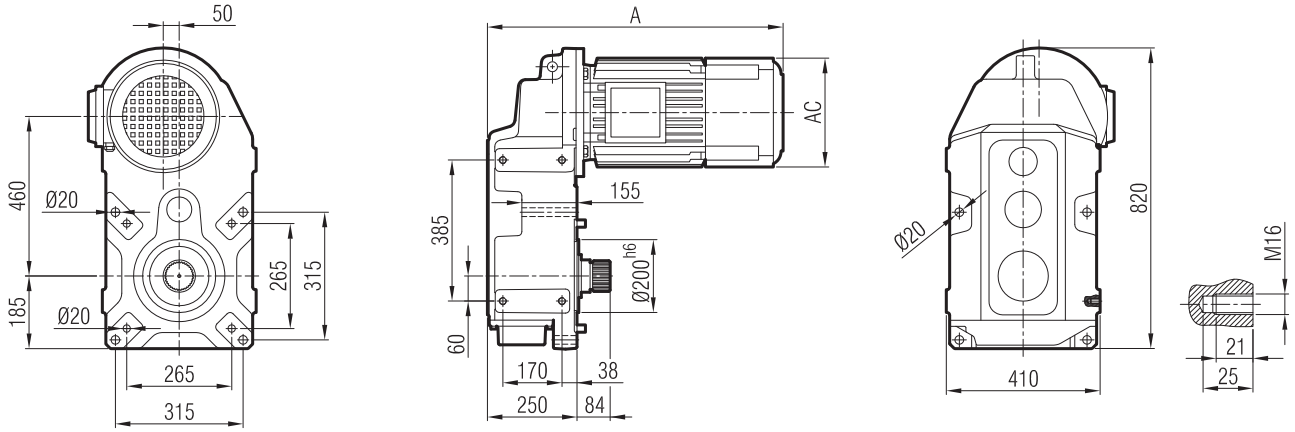

	63	71	80	90 S	90 L	100	112	132 S	132 M	160 M	160 L	180 M	180 L				
A							696	802	840	938	971	999	1037				
AC							232	279	279	323	323	370	370				



İRCPM 103

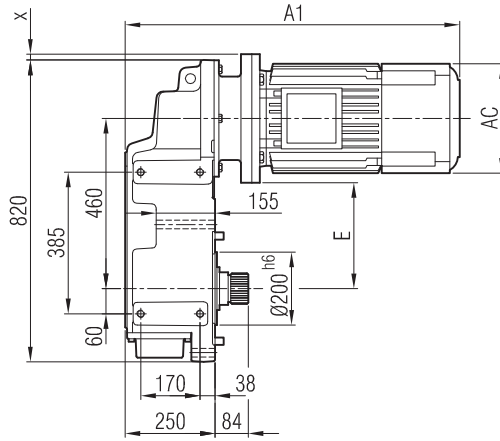
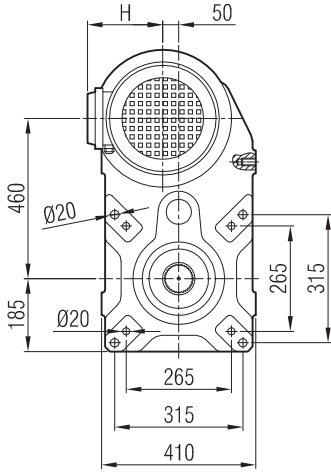

	A1	AC	E	H	x
112/B5	785	232	335	149	-
132 S/B5	894	279	310	182	-
132 M/B5	932	279	310	182	-
160 M/B5	1026	323	285	225	-
160 L/B5	1070	323	285	225	-
180 M/B5	1083	370	285	248	-
180 L/B5	1121	370	285	248	-

"A1" Ölçüsü Frenli Motorlar içindir.
Dimension "A1" is for motors with brake
Maß "A1" ist für Motoren mit Bremse

İRCP 103

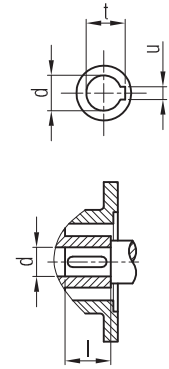
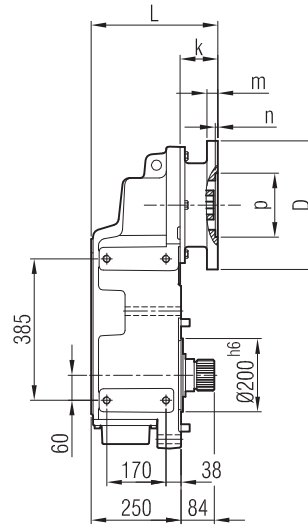
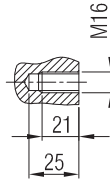
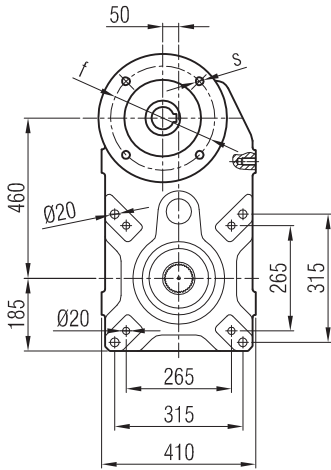

	L	Øp	Øf	ØD	s	k	m	n	Ød	l	t	u
112/B5	307	180	215	250	M12	57	15	5	28	60	31.3	8
132/B5	334	230	265	300	M14	84	17	6	38	80	41.3	10
160/B5	341	250	300	350	M14	91	18	6.5	42	110	45.3	12
180/B5	341	250	300	350	M14	91	18	6.5	48	110	51.8	14

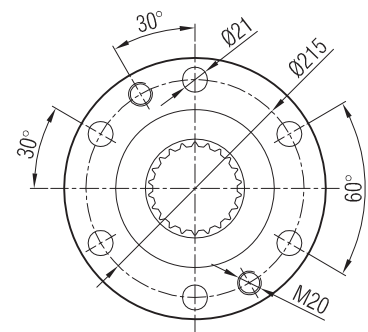
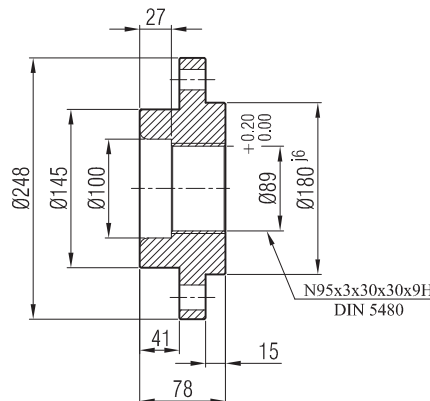
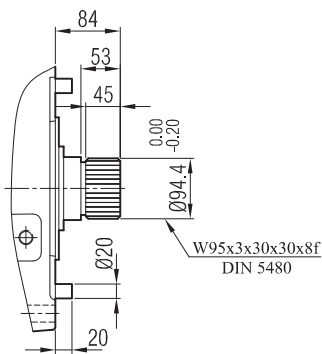



İRCM 123

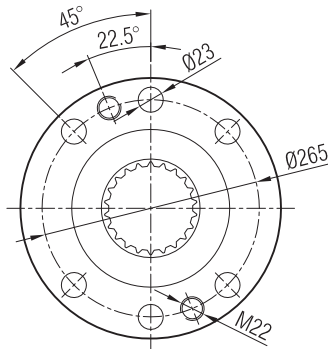
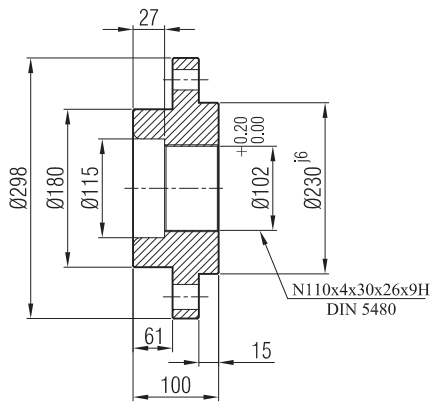
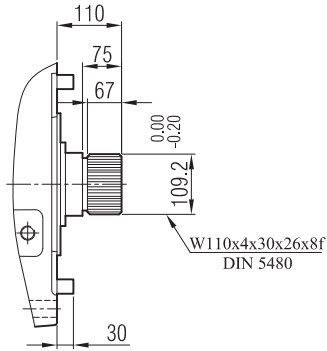
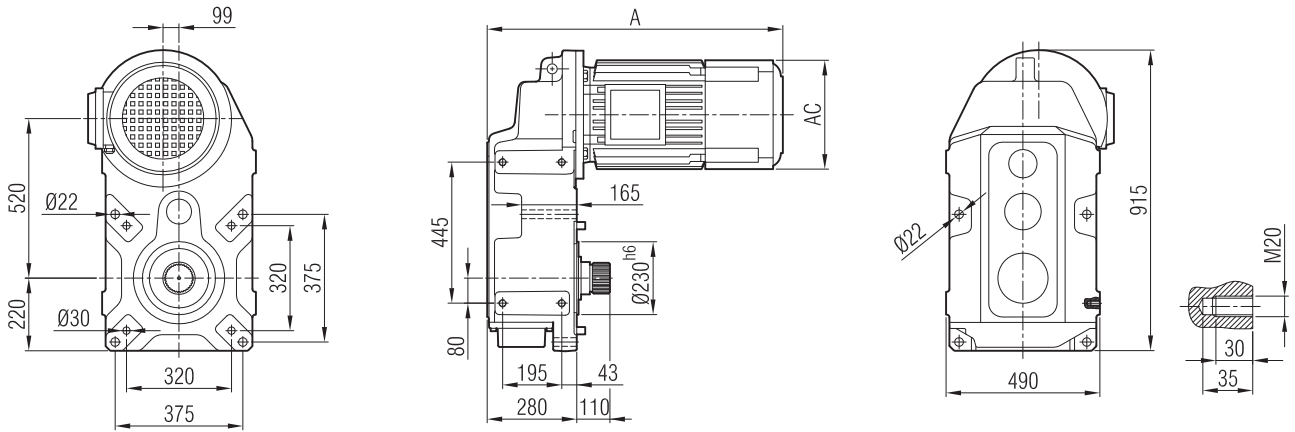

	63	71	80	90 S	90 L	100	112	132 S	132 M	160 M	160 L	180 M	180 L	200	225 S	225 M	
A								832	870	968	1001	1029	1067	1136	1140	1140	
AC								279	279	323	323	370	370	415	456	456	



İRCPM 123

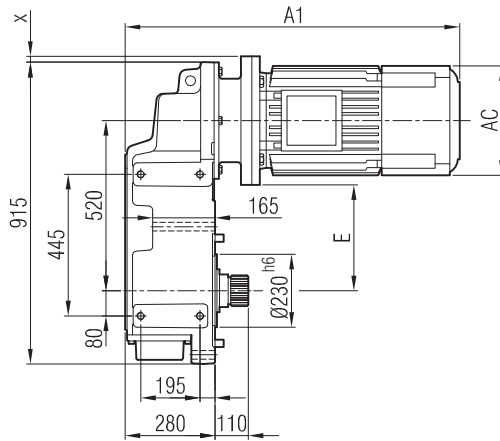
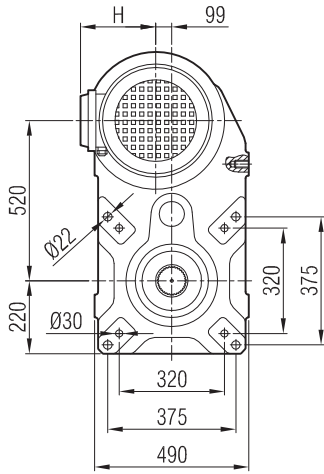

	A1	AC	E	H	x
132 S/B5	897	279	370	182	-
132 M/B5	935	279	370	182	-
160 M/B5	1049	323	345	225	-
160 L/B5	1093	323	345	225	-
180 M/B5	1113	370	345	248	-
180 L/B5	1151	370	345	248	-
200/B5	1218	415	320	275	25
225 S/B5	1236	456	295	285	50
225 M/B5	1261	456	295	285	50

"A1" Ölçüsü Frenli Motorlar içindir.
Dimension "A1" is for motors with brake
Maß "A1" ist für Motoren mit Bremse

İRCP 123

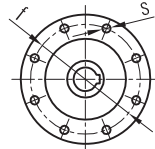
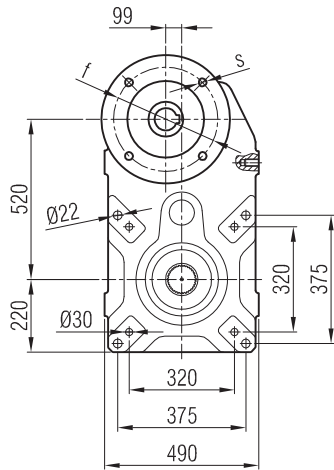

≥ 225 B5 Tip/Type/Typ

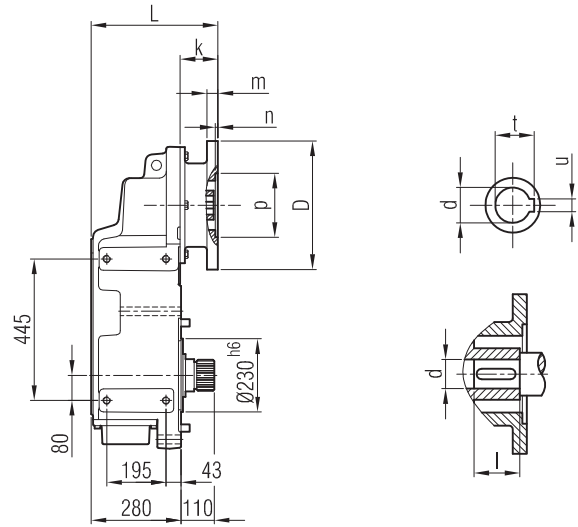
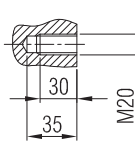

	L	Øp	Øf	ØD	s	k	m	n	Ød	l	t	u
132/B5	337	230	265	300	M14	61	17	6	38	80	41.3	10
160/B5	364	250	300	350	M14	91	18	6.5	42	110	45.3	12
180/B5	371	250	300	350	M14	91	18	6.5	48	110	51.8	14
200/B5	371	300	350	400	M16	159	20	6.5	55	110	59.3	16
225/B5	371	350	400	450	M16	168	22	6.5	60	140	64.4	18

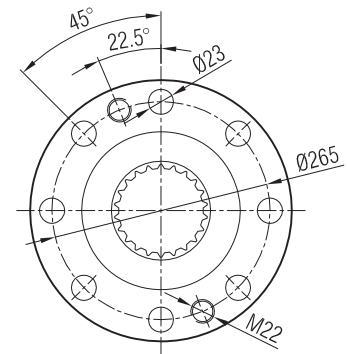
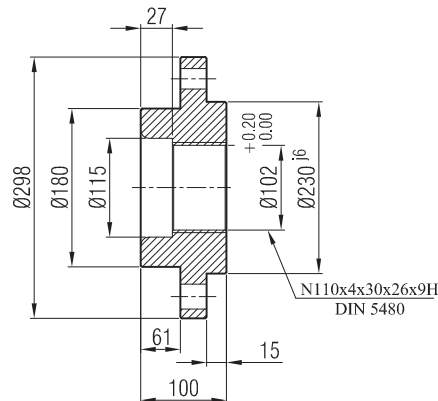
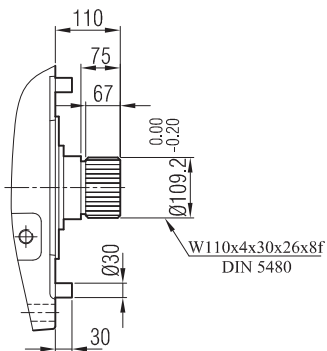



TİP / TYPE / TYP

IRCM - IRCPM - IRC - IRCP } 73-83-93-103-123

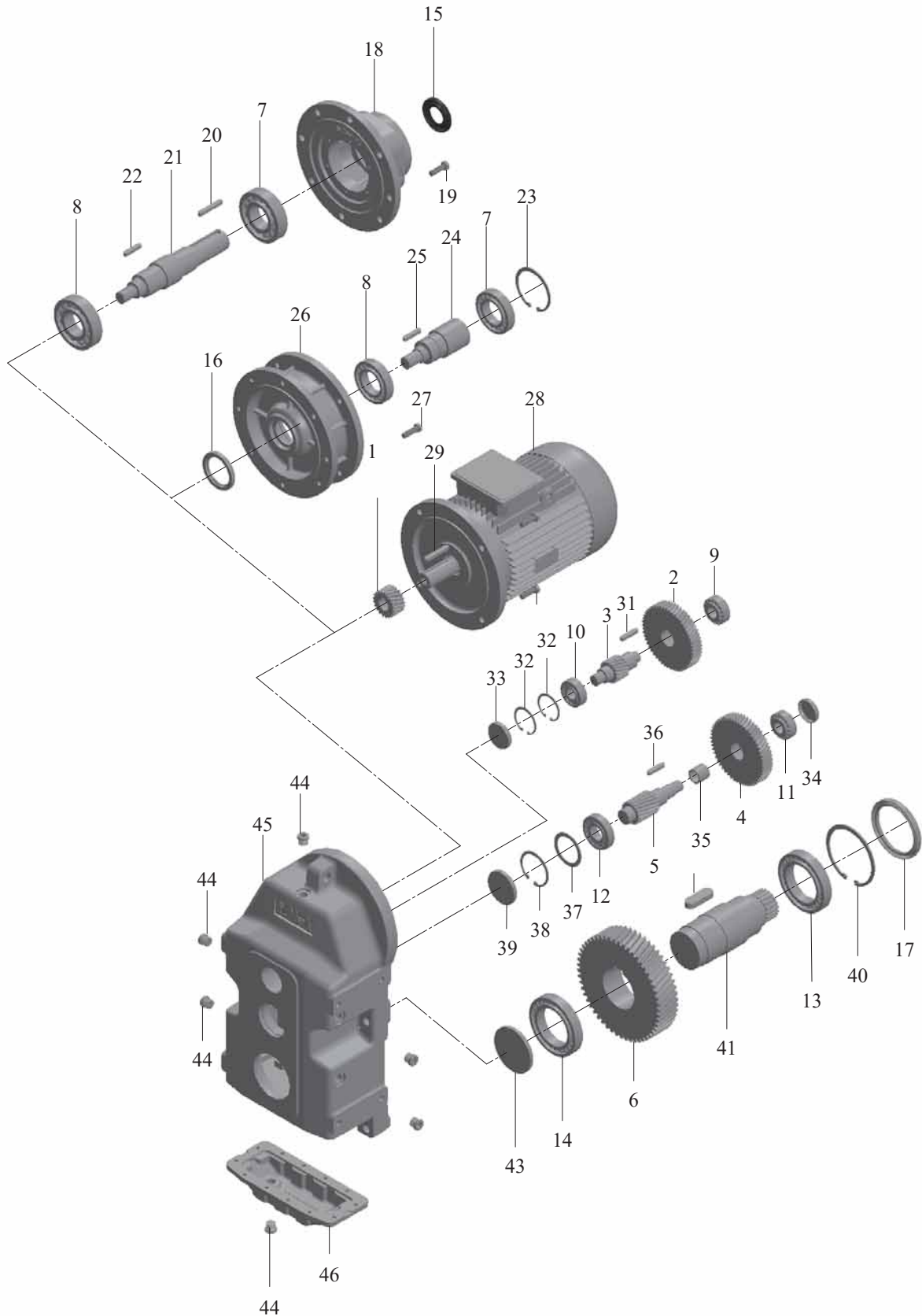



TİP / TYPE / TYPE

IRCM / IRCPM / IRC / IRCP } 73-83-93-103-123

1 - Dişli Z1	1 - Gear Z1	1 - Pignon Z1
2 - Dişli Z2	2 - Gear Z2	2 - Pignon Z2
3 - Milli Dişli Z3	3 - Gear Z3	3 - Pignon Z3
4 - Dişli Z4	4 - Gear Z4	4 - Pignon Z4
5 - Milli Dişli Z5	5 - Gear Z5	5 - Pignon Z5
6 - Dişli Z6	6 - Gear Z6	6 - Pignon Z6
7 - Rulman	7 - Bearing	7 - Roulement
8 - Rulman	8 - Bearing	8 - Roulement
9 - Rulman	9 - Bearing	9 - Roulement
10 - Rulman	10 - Bearing	10 - Roulement
11 - Rulman	11 - Bearing	11 - Roulement
12 - Rulman	12 - Bearing	12 - Roulement
13 - Rulman	13 - Bearing	13 - Roulement
14 - Rulman	14 - Bearing	14 - Roulement
15 - Keçe	15 - Seal	15 - Joint
16 - Keçe	16 - Seal	16 - Joint
17 - Keçe	17 - Seal	17 - Joint
18 - Motorsuz Kapak	18 - Gear Case Cover	18 - Couvercle
19 - Civata	19 - Bolt	19 - Vis
20 - Kama	20 - Key	20 - Clavette
21 - Giriş Mili	21 - Input Shaft	21 - Arbre d'entrée
22 - Kama	22 - Key	22 - Clavette
23 - Segman	23 - Circlip	23 - Circlip
24 - Ara Bağlantı Mili	24 - Connection Shaft	24 - Arbre connecteur
25 - Kama	25 - Key	25 - Clavette
26 - Pam Flanş (IEC)	26 - IEC Flange	26 - Bride IEC
27 - Civata	27 - Bolt	27 - Vis
28 - Motor	28 - Electric Motor	28 - Moteur électrique
29 - Kama	29 - Key	29 - Clavette
30 - Civata	30 - Bolt	30 - Vis
31 - Kama	31 - Key	31 - Clavette
32 - Segman	32 - Circlip	32 - Circlip
33 - Tapa	33 - Locking Cover	33 - Bouchon
34 - Tapa	34 - Locking Cover	34 - Bouchon
35 - Burç	35 - Spacer	35 - Anneau d'espacement
36 - Kama	36 - Key	36 - Clavette
35 - Pul	35 - Washer	35 - Joint
38 - Segman	38 - Circlip	38 - Circlip
39 - Tapa	39 - Locking Cover	39 - Bouchon
40 - Segman	40 - Circlip	40 - Circlip
41 - Çıkış Mili	41 - Output Shaft	41 - Arbre de sortie
42 - Kama	42 - Key	42 - Clavette
43 - Tapa	43 - Locking Cover	43 - Bouchon
44 - Yağ Tapası	44 - Oil Plug	44 - Bouchon d'huile
45 - Gövde	45 - Gear Case	45 - Carter
46 - Kapak	46 - Cover	46 - Couvercle



REDÜKTÖR & VARYATÖR SAN. VE TİC. A.Ş.

Fabrika - Merkez Satış

Şeyhli Sanayi Caddesi No:1 Pendik / İSTANBUL - TÜRKİYE
Tel. +90 216 378 03 26 (Pbx) - Fax. +90 216 378 06 86

Şatış Ofisi

Demirkapı Mah. Keresteciler Sit. Rıza Uzun Sk. No:5 Topçular / İSTANBUL - TÜRKİYE
Tel. +90 212 567 87 32/33 - Fax. +90 212 612 61 17

imak@imakreduktor.com

www.imakreduktor.com



Vinç Sistemleri Kaldırma Redüktörü / Hoist Drive Geared Motor / Motoréducteurs à Tambour

2017